



## MRI3T POWER MEASUREMENT KIT

### OPERATING INSTRUCTIONS

©COPYRIGHT 2023 BY BIRD TECHNOLOGIES, INC.  
INSTRUCTION BOOK PART NUMBER 920-4300A750 REV. C

THRULINE® IS A REGISTERED TRADEMARK OF  
BIRD ELECTRONIC CORPORATION  
MICROSOFT® AND WINDOWS® ARE REGISTERED TRADEMARKS  
OF THE MICROSOFT CORPORATION



# Quick Start Guide

## WARNING

Disable RF output prior to disconnecting any RF cable connections

- 1 Connect AC supply to Load.  
Verify Load fans are operating.  
Connect RF Generator output to 5014M input.  
Connect 5014M RF output to Load RF input.

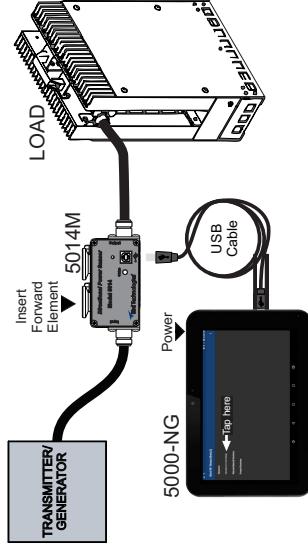

- 2 Using reference card, select appropriate Element for frequency and power level.  
Remove plug from forward element socket.  
Insert Element into forward element socket.

**Note:** Leave plug in reverse socket.

## QUICK START GUIDE

- 3 Press power button on 5000-NG, wait for RF Meter software to be displayed.  
Connect 5000-NG to 5014M using USB cable.  
Tap the name of the sensor once displayed.

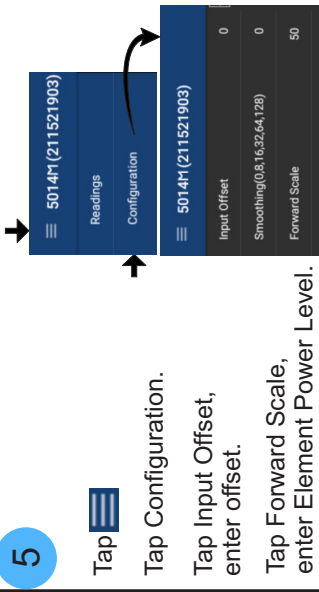
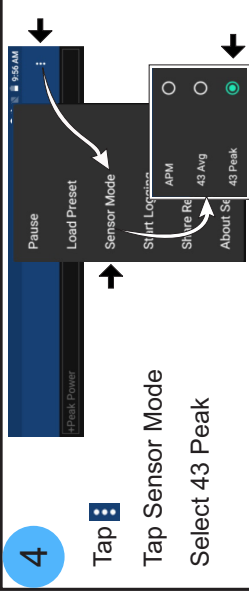

**Note:** Find Element offset and power level on reference card.



## Safety Precautions

The following are general safety precautions that are not necessarily related to any specific part or procedure, and do not necessarily appear elsewhere in this publication. These precautions must be thoroughly understood and apply to all phases of operation and maintenance.

**WARNING**

**Keep Away From Live Circuits**

Operating Personnel must at all times observe general safety precautions. Do not replace components or make adjustments to the inside of the test equipment with the high voltage supply turned on. To avoid casualties, always remove power.

**WARNING**

**Shock Hazard**

Do not attempt to remove the RF transmission line while RF power is present.

**WARNING**

**Do Not Service Or Adjust Alone**

Under no circumstances should any person reach into an enclosure for the purpose of service or adjustment of equipment except in the presence of someone who is capable of rendering aid.

**WARNING**

**Safety Earth Ground**

An uninterruptible earth safety ground must be supplied from the main power source to test instruments. Grounding one conductor of a two conductor power cable is not sufficient protection. Serious injury or death can occur if this grounding is not properly supplied.

**WARNING**

**Resuscitation**

Personnel working with or near high voltages should be familiar with modern methods of resuscitation.

**WARNING**

**Remove Power**

Observe general safety precautions. Do not open the instrument with the power on.

## Safety Symbols

---

**WARNING**

Warning notes call attention to a procedure, which if not correctly performed, could result in personal injury.

**CAUTION**

Caution notes call attention to a procedure, which if not correctly performed, could result in damage to the instrument.



The caution symbol appears on the equipment indicating there is important information in the instruction manual regarding that particular area.



This symbol indicates that the unit radiates heat and should not be touched while hot.

**Note:** *Calls attention to supplemental information.*

## Warning Statements

The following safety warnings appear in the text where there is danger to operating and maintenance personnel, and are repeated here for emphasis.

**WARNING**

**KIT CONTAINS FERROUS MATERIAL**

Personal injury could result due to strong attraction to the magnet.  
Refer to service documentation prior to servicing.

On page 1.

**WARNING**

Never attempt to connect or disconnect RF equipment from the transmission line while RF power is being applied.  
Leaking RF energy is a potential health hazard.

On page 6.

**WARNING**

Load may be hot. Allow load to cool before touching.

On page 10.

**WARNING**

RF voltage may be present in RF element socket. Keep element in socket during operation.

On page 8.

## Caution Statements

---

The following equipment cautions appear in the text and are repeated here for emphasis.

**CAUTION**

Only use the supplied AC adapter to charge the unit. Due to the amperage required to charge the 5000-NG, charging from another power source (i.e. laptop USB port) may damage that power source.

On page 3.

**CAUTION**

Ensure the load's fans are running before applying RF power. Failure to do so will damage the load and other system components.

On page 5.

**CAUTION**

Packing foam may melt if heated. Allow load to cool before packing.

On page 10.

**CAUTION**

Cooling without fans running will damage load.

On page 10.

**CAUTION**

Do not use harsh or abrasive detergents for cleaning.

On page 45.



## **Safety Statements**

---

### **USAGE**

ANY USE OF THIS INSTRUMENT IN A MANNER NOT SPECIFIED BY THE MANUFACTURER MAY IMPAIR THE INSTRUMENT'S SAFETY PROTECTION.

### **USO**

EL USO DE ESTE INSTRUMENTO DE MANERA NO ESPECIFICADA POR EL FABRICANTE, PUEDE ANULAR LA PROTECCIÓN DE SEGURIDAD DEL INSTRUMENTO.

### **BENUTZUNG**

WIRD DAS GERÄT AUF ANDERE WEISE VERWENDET ALS VOM HERSTELLER BESCHRIEBEN, KANN DIE GERÄTESICHERHEIT BEEINTRÄCHTIGT WERDEN.

### **UTILISATION**

TOUTE UTILISATION DE CET INSTRUMENT QUI N'EST PAS EXPLICITEMENT PRÉVUE PAR LE FABRICANT PEUT ENDOMMAGER LE DISPOSITIF DE PROTECTION DE L'INSTRUMENT.

### **IMPIEGO**

QUALORA QUESTO STRUMENTO VENISSE UTILIZZATO IN MODO DIVERSO DA COME SPECIFICATO DAL PRODUTTORE LA PROZIONE DI SICUREZZA POTREBBE VENIRNE COMPROMESSA.

## **SERVICE**

SERVICING INSTRUCTIONS ARE FOR USE BY SERVICE - TRAINED PERSONNEL ONLY. TO AVOID DANGEROUS ELECTRIC SHOCK, DO NOT PERFORM ANY SERVICING UNLESS QUALIFIED TO DO SO.

## **SERVICIO**

LAS INSTRUCCIONES DE SERVICIO SON PARA USO EXCLUSIVO DEL PERSONAL DE SERVICIO CAPACITADO. PARA EVITAR EL PELIGRO DE DESCARGAS ELÉCTRICAS, NO REALICE NINGÚN SERVICIO A MENOS QUE ESTÉ CAPACITADO PARA HACERLO.

## **WARTUNG**

ANWEISUNGEN FÜR DIE WARTUNG DES GERÄTES GELTEN NUR FÜR GESCHULTES FACHPERSONAL.

ZUR VERMEIDUNG GEFÄHRLICHE, ELEKTRISCHE SCHOCKS, SIND WARTUNGSARBEITEN AUSSCHLIEßLICH VON QUALIFIZIERTEM SERVICEPERSONAL DURCHZUFÜHREN.

## **ENTRETIEN**

L'EMPLOI DES INSTRUCTIONS D'ENTRETIEN DOIT ÊTRE RÉSERVÉ AU PERSONNEL FORMÉ AUX OPÉRATIONS D'ENTRETIEN. POUR PRÉVENIR UN CHOC ÉLECTRIQUE DANGEREUX, NE PAS EFFECTUER D'ENTRETIEN SI L'ON N'A PAS ÉTÉ QUALIFIÉ POUR CE FAIRE.

## **ASSISTENZA TECNICA**

LE ISTRUZIONI RELATIVE ALL'ASSISTENZA SONO PREVISTE ESCLUSIVAMENTE PER IL PERSONALE OPPORTUNAMENTE ADDESTRATO. PER EVITARE PERICOLOSE SCOSSE ELETTRICHE NON EFFETTUARE ALCUNA RIPARAZIONE A MENO CHE QUALIFICATI A FARLA.

**RF VOLTAGE MAY BE PRESENT IN RF ELEMENT SOCKET - KEEP ELEMENT IN SOCKET DURING OPERATION.**

**DE LA TENSION H.F. PEAT ÊTRE PRÉSENTE DANS LA PRISE DE L'ÉLÉMENT H.F. - CONSERVER L'ÉLÉMENT DANS LA PRISE LORS DE L'EMPLOI.**

**HF-SPANNUNG KANN IN DER HF-ELEMENT-BUCHSE ANSTEHEN - ELEMENT WÄHREND DES BETRIEBS EINGESTÖPSELT LASSEN.**

**PUEDE HABER VOLTAJE RF EN EL ENCHUFE DEL ELEMENTO RF - MANTENGA EL ELEMENTO EN EL ENCHUFE DURANTE LA OPERACION.**

**IL PORTAELEMENTO RF PUÒ PRESENTARE VOLTAGGIO RF - TENERE L'ELEMENTO NELLA PRESA DURANTE IL FUNZIONAMENTO.**

## About This Manual

---

This manual covers the operating and maintenance instructions for the following models:

MRI3TKIT	5000-NG
5014M	8581A

## Changes to this Manual

---

We have made every effort to ensure this manual is accurate at the time of publication. If you should discover any errors or if you have suggestions for improving this manual, please send your comments to our factory. This manual may be periodically updated, when inquiring about updates to this manual refer to the part number and revision level on the title page.

## Chapter Layout

---

**Introduction** — Lists and describes the components of the kit. Also identifies the parts of the DPM, describes the functions of the keys, and explains the meaning of indicators which may be displayed.

**Setup** — Gives directions for setting up the kit and connecting the DPM, DPS, and load.

**Operation** — Explains how to make measurements with the DPM, and the special functions used with specific sensors.

**Maintenance** — Lists routine maintenance tasks for the kit, and troubleshooting tips for common problems. Specifications and battery information are also included.

# TABLE OF CONTENTS

<b>Quick Start Guide</b> .....	<b>i</b>
<b>Safety Precautions</b> .....	<b>iii</b>
Safety Symbols .....	iv
Warning Statements .....	v
Caution Statements .....	vi
Safety Statements .....	vii
<b>About This Manual</b> .....	<b>x</b>
Changes to this Manual .....	x
Chapter Layout .....	x
<b>Chapter 1 Introduction</b> .....	<b>1</b>
Items Supplied .....	1
DPM Controls and Connectors .....	2
DPM Power Source .....	3
<b>Chapter 2 Setup</b> .....	<b>4</b>
Setting Up .....	4
Charging the DPM Battery .....	4
Load .....	5
Connections .....	6
Connecting Sensor to RF Power .....	7
Connecting to the DPM .....	7
Elements .....	8
DPM Element Configuration .....	8
<b>Chapter 3 Operation</b> .....	<b>9</b>
Operating the Measurement Kit .....	9
Sensor Elements .....	9
Using the DPM .....	9
Turning Off the Unit .....	10

- Directional Power Sensor (DPS) Measurements ..... 11
  - Average Power ..... 11
  - VSWR ..... 12
  - 5014 Sensor Element Types ..... 13
- Chapter 4 User Interface ..... 14**
- RF Power Meter Software User Interface ..... 14
  - Sensor Displays and Menus ..... 15
  - Display Area ..... 16
  - Display Controls Menu ..... 17
  - Sensor Operations Menu ..... 26
  - Logging ..... 27
  - Share Readings via Bluetooth ..... 29
  - Preferences Menu ..... 30
  - Session Files ..... 31
- 5000-NG Operating System User Interface ..... 34
  - Camera ..... 34
  - Memory Expansion ..... 35
  - Eject Memory Device ..... 35
  - 5000-NG Communications Settings ..... 36
  - Pairing a Bluetooth Device with the 5000-NG ..... 37
  - Connecting to a Wi-Fi Network ..... 38
- Chapter 5 File Transfers ..... 39**
- File Transfers ..... 39
  - Transfer Files from Internal Storage to USB Drive or MicroSD ..... 39
  - Transfer Files from the 5000-NG to a PC via USB Cable ..... 41
  - Transfer Files from 5000-NG to a PC using Bluetooth ..... 41
- Chapter 6 Maintenance ..... 45**
- Troubleshooting ..... 45
- Cleaning ..... 45

DPM Maintenance .....	46
Package File (APK) Installation .....	46
Storing the DPM .....	47
Customer Service .....	47
Parts List .....	48
Color Codes .....	50
Sensor Elements .....	50
Cables .....	50
Specifications .....	50
Overall Kit .....	50
Meter (Model 5000-NG) .....	52
Sensor (Model 5014M) .....	53
Elements .....	53
Cables .....	53
Adapters .....	54
Load (Model 8581A) .....	54
<b>Limited Warranty .....</b>	<b>55</b>

The Medical 3T Power Measurement Kit is designed for use in the calibration and testing of MRI equipment.

**WARNING**

**KIT CONTAINS FERROUS MATERIAL**

Personal injury could result due to strong attraction to the magnet.  
Refer to service documentation prior to servicing.

## Items Supplied

---

The 3T Power Measurement Kit has the following components:

**Carrying Case** — Hard case for storage of the kit. Wheeled for easier transport.

**Bird 5000-NG (DPM)** — Digital power meter display used with the Directional Power Sensor. It is powered by an internal battery, but can also be powered from AC adapter. It displays Peak Average Power. It can also display VSWR (Match), Forward Average Power, and Reflected Average Power.

**Bird 5014M (DPS)** — Directional power sensor used with the DPM. Thruline measurement. Bird 43-Type Elements are provided. Can also use Bird APM-Type elements.

**Bird 8581A Forced-Air Load** — Forced-air cooled load. The load fans are powered from an AC adapter. The load has no controls - fans turn on as soon as the load is plugged in.

**Accessories** — Assorted elements, cables, and adapters are also included in the kit (See [“Parts List” on page 48](#) for an exploded view and a complete list).



## DPM Controls and Connectors

**Figure 1 5000-NG Controls and Connectors**

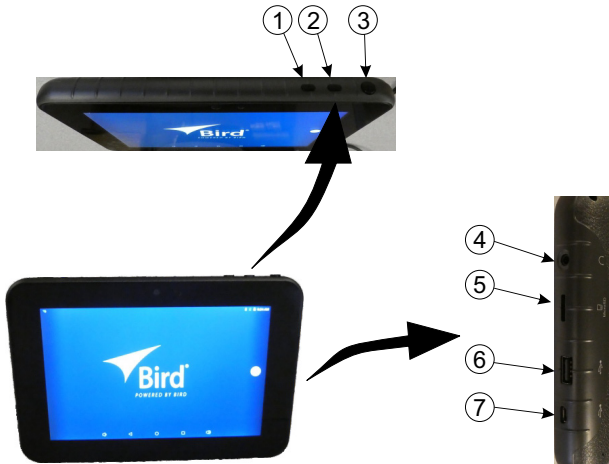

<i>Item</i>	<i>Name</i>	<i>Description</i>
1	Volume Down (-)	Increases volume when pressed. When this button and power button are pressed simultaneously a screenshot is taken of the display.
2	Volume Up (+)	Decreases volume when pressed.
3	Power Button (⏻)	Used to power on and off the 5000-NG. Also used to “wake” the 5000-NG when in sleep mode.
4	Headphone Jack	3.5 mm jack for headphone connection.
5	MicroSD Card Slot	Memory card slot used to augment internal storage.
6	USB-A	USB device port for connection to a USB Drive, PC, or Bird Power Sensor.
7	USB-Micro Charger Input	Input connector for charging the 5000-NG using the supplied charger. See " <a href="#">Charging the DPM Battery</a> " on page 4. May also be used to connect to a PC for file management.

## DPM Power Source

---

**CAUTION**

Only use the supplied AC adapter to charge the unit. Due to the amperage required to charge the 5000-NG, charging from another power source (i.e. laptop USB port) may damage that power source.

The 5000-NG has an internal battery capable of 8 hrs of operation from a full charge, the actual battery life will vary according to the amount of time the display is active, see ["Specifications" on page 50](#).

The internal battery will automatically recharge when the AC adapter is connected to the micro-USB port on the 5000-NG. The 5000-NG can be used for RF power measurement while charging.

The internal battery is not field replaceable.

## Setting Up

---

1. Turn off the signal source.
2. Turn on the DPM. Press and hold power key for approximately 3 seconds then release.
3. Connect the load to an AC supply and check that the fans turn on. See "[Load](#)" on page 5.
4. Connect the source to the power sensor. See "[Connections](#)" on page 6.
5. Connect the DPS to the load.
6. Connect the DPS to the meter (DPM).
7. Install the proper elements into the DPS. See "[Elements](#)" on page 8.
8. Set the full scale power.

## Charging the DPM Battery

---

### CAUTION

Only use the supplied AC adapter to charge the unit. Due to the amperage required to charge the 5000-NG, charging from another power source (i.e. laptop USB port) may damage that power source.

The 5000-NG has an internal battery capable of up to 8 hrs of operation from a full charge, the actual battery life will vary according to the amount of time the display is active, see "[Specifications](#)" on page 50.

1. Connect AC adapter to the micro-USB port on the 5000-NG.  
**Note:** *The 5000-NG can be used for RF power measurement while charging.*
2. Allow the 5000-NG to charge until charge indicator indicates the unit is fully charged.

## Load

Insert the AC adapter's barrel connector into the load's DC connector. Plug the adapter into a wall receptacle.

### CAUTION

Ensure the load's fans are running before applying RF power. Failure to do so will damage the load and other system components.

**Figure 2 Load Power Supply**

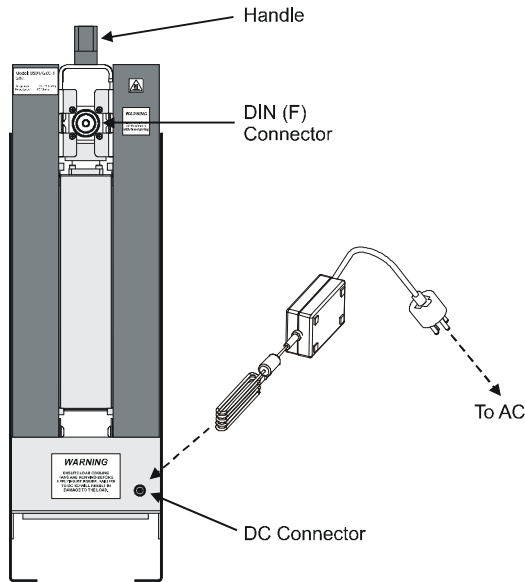

## Connections

Figure 3 DPM Connections

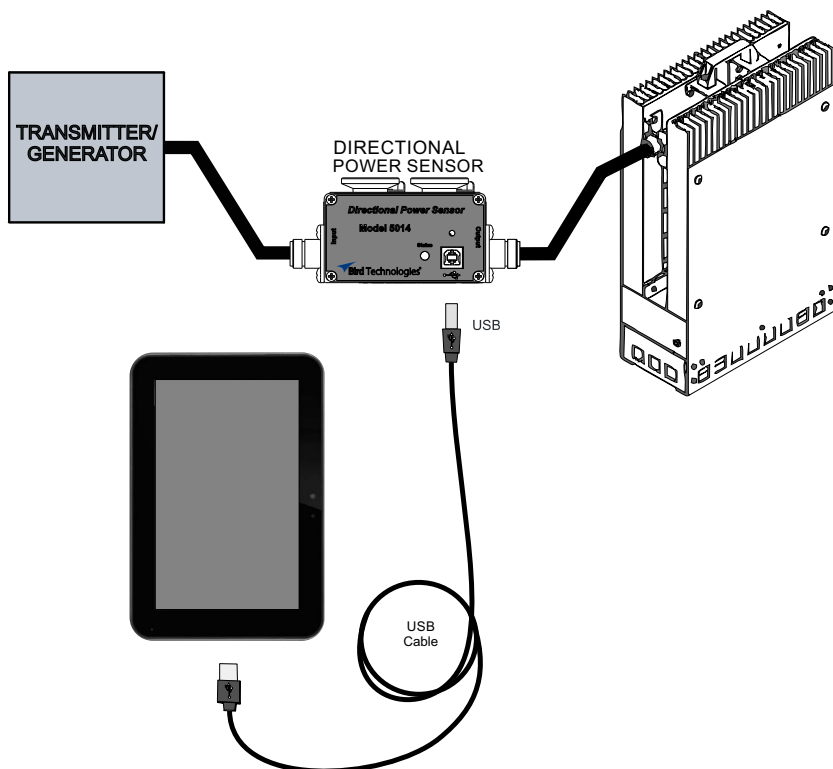

### WARNING

Never attempt to connect or disconnect RF equipment from the transmission line while RF power is being applied.  
Leaking RF energy is a potential health hazard.

## Connecting Sensor to RF Power

---

1. Connect the DPS Output to the load using the 7/16 to 7/16 cable provided.

**Note:** *The arrow on the DPS should point towards the load.*

2. Connect the DPS Input to the RF source using the supplied adapters and cables.

**Figure 4** *DPS RF Connections*

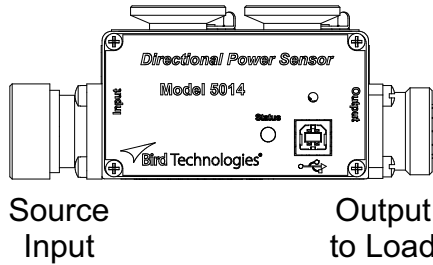

## Connecting to the DPM

---

1. Connect USB cable to Bird Power Sensor. See [Figure 3 on page 6](#).
2. Connect USB cable to 5000-NG.

**Note:** *The Bird RF Power Meter Software will save all sensor settings (by serial number). Sensor settings will automatically load when the sensor is connected. Settings are saved in a Session File. Session Files are saved in the Session List.*

3. The Power Sensor model number and serial number will be displayed on the Bird RF Power Meter Software device selection screen.

**Figure 5** *Device Selection Screen*

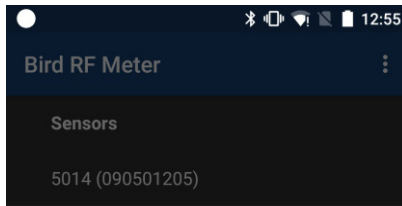

4. Tap the Power Sensor model number to connect to the Power Sensor.

## Elements

### WARNING

RF voltage may be present in RF element socket. Keep element in socket during operation.

The Directional Power Sensor (DPS) uses Bird Plug-In Elements. These are labeled with a max power and a frequency range. The generator frequency should be within the element range, and the forward element power should be 10x the reflected element power.

The element in the forward socket should be inserted with its arrow pointing in the direction of forward power, as shown below.

**Note:** *The reflected element socket should have the metal blanking plug installed.*

**Figure 6 Element Orientation**

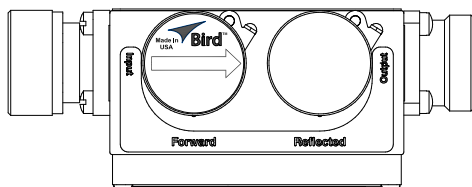



## DPM Element Configuration

**Note:** *The forward full scale power and element type must be manually entered.*

**Note:** *The Bird DPS uses Bird Plug-In Elements. These are labeled with a max power and a frequency range.*

**Note:** *The transmitter frequency should be within the element range.*

1. Tap the Sensor Operation Menu .
2. Tap Sensor Mode.
3. Select mode based on elements inserted in the sensor. See ["5014 Sensor Element Types" on page 13](#).
4. Tap the Display Controls Menu .
5. Tap Configuration.
  - a. Enter the Offset value (the offset can be found on the element reference card included with the kit).
  - b. Enter Forward Scale (watt rating of the forward element).
6. Tap the Display Controls Menu .
7. Tap Readings.

Once the kit is set up, the load is plugged in, and the element settings are entered into the DPM, the DPM is ready to make measurements.

## Operating the Measurement Kit

---

### Sensor Elements

---

**WARNING**

RF voltage may be present in RF element socket. Keep element in socket during operation.

If a different sensor element is required, remove RF power before changing elements. After changing elements perform [Measurement Type \(Matches Element used\)](#) and "[Setting Scale](#)" on page 9.

### Using the DPM

---

#### Set Offset

1. Tap the Display Controls Menu .
2. Tap Configuration.
3. Enter the Offset value (the offset can be found on the element reference card included with the kit).

#### Measurement Type (Matches Element used)

1. Tap the Sensor Operation Menu .
2. Tap Sensor Mode.
3. Select measurement type based on elements inserted in the sensor. See "[5014 Sensor Element Types](#)" on page 13.

#### Setting Scale

1. Tap the Display Controls Menu .
2. Tap Configuration.
3. Enter Forward Scale (watt rating of the forward element).

#### Display a Graph of Power Readings

See "[How to Display a Graph](#)" on page 19.



## Performing a Screen Shot

1. Press and hold the power and volume down buttons for approximately two seconds will perform a screen shot of the current screen on the DPM.

**Note:** *The image file will be saved in the 5000-NG's internal memory in a folder named Screenshots.*

## Turning Off the Unit

### WARNING

Load may be hot. Allow load to cool before touching.

### CAUTION

Cooling without fans running will damage load.

1. Turn off the RF source.

**Note:** *Do not turn off the load fans.*

2. Turn off the DPM:
  - a. Press and Hold the power button key for 2 seconds.
  - b. Select the Power off option.

### Figure 7 Power Button Selection Options

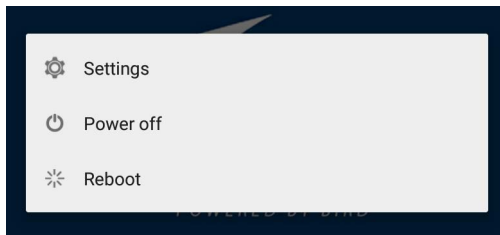

3. Wait 10 minutes for the load to cool to room temperature.
4. Disconnect the AC power supply from the load.

### CAUTION

Packing foam may melt if heated. Allow load to cool before packing.

5. Put kit components back into the case.

## Directional Power Sensor (DPS) Measurements

---

**Figure 8** Directional Power Sensor



The 5014 can be used to measure:

- Forward Power
- Reflected Power
- Match Measurements
- Sensor Temperature

### Average Power

---

Average power is a measure of the equivalent “heating” power of a signal, as measured with a calorimeter. It measures the total RF power in the system, and does not depend on number of carriers or modulation scheme. The WPS is a broadband sensor that measures power across its entire frequency range. Its diodes operate in their ‘square law’ region so that the detector output is directly proportional to the average power, without any additional error correction.

Average power is the most important measurement of any transmission system since the average power is normally specified on the operating license. It is also valuable as a maintenance tool, showing overall system health, and for calibration.

**Figure 9** Average and Peak Envelope Power - Square Wave Signal

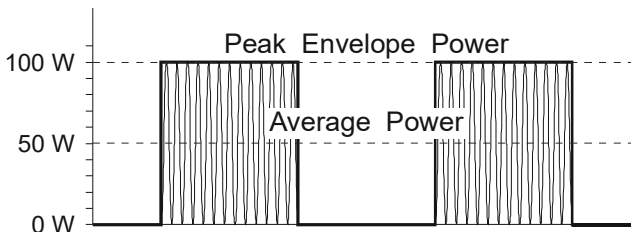

---

## VSWR

---

VSWR measures the relation between forward and reflected average power. The Bird Wideband Power Sensor calculates the VSWR from the Forward and Reflected Average Power measurements. Rho and Return Loss are also the same measurement, but in different units:

### Rho

$$Rho(\rho) = \sqrt{P_R/P_F}$$

### VSWR

$$VSWR = \frac{1 + \rho}{1 - \rho}$$

### Return Loss (dB)

$$ReturnLoss(dB) = 10\log(P_R/P_F)$$

The health of the feedline and antenna systems can be monitored using VSWR measurement under full power operating conditions. High VSWR is an indicator of feed line damage, overtightened cable or feed line clamps, or antenna changes/damage due to weather conditions, icing, or structural damage to the tower.

## 5014 Sensor Element Types

---

The DPS series sensors utilize elements in order to make power measurements. Each element has an arrow on it that represents the direction in which it measures power. The elements ignore power in the opposite direction with a directivity of at least 25 dB. The DPS series can make power measurements using either 43 type or APM/DPM elements, and the readings available vary, based on which elements are being used.

Since the DPS uses two elements, it can measure the quality of the system by comparing the forward and the reflected power. This is usually presented in the form of VSWR or Return Loss.

### 43 Type Elements

The 43 type elements are normally used to measure peak power. These elements can measure the peak power of a system with an accuracy of +/-8% of full scale as long as the signal meets the following requirements:

- At least 15 pps (pulses per second)
- Minimum pulse width of 15 ns (800 ns if frequency is greater than 100 MHz)
- Minimum Duty Cycle of 0.01%

In addition, 43 type elements can be used to measure average power in signals with a peak-to-average ratio close to 1, like a CW or FM signals. In these cases, the average power is measured with an accuracy of +/- 5% of full scale.

### APM/DPM Elements

The APM/DPM elements are used to measure true average power. True average power means the sensor provides equivalent heating power of the signal, regardless of modulation or number of carriers. These elements can measure average power with an accuracy of +/-5% of reading from full scale down to 2.5% of full scale.

**Note:** *The equivalent heating power is dependent on the duty cycle of a signal. If a system puts out 50 watts with a 50% duty cycle, the APM/DPM elements will measure 25 watts.*

The user interface objects discussed in this chapter consists of the [RF Power Meter Software User Interface](#) and the [5000-NG Operating System User Interface](#).

- ["RF Power Meter Software User Interface" on page 14](#)
- ["5000-NG Operating System User Interface" on page 34](#)

## **RF Power Meter Software User Interface**



---

- ["Sensor Displays and Menus" on page 15](#)
- ["Display Area" on page 16](#)
- ["Display Controls Menu" on page 17](#)
- ["Sensor Operations Menu" on page 26](#)
- ["Logging" on page 27](#)
- ["Preferences Menu" on page 30](#)
- ["Session Files" on page 31](#)

Sensor Displays and Menus

Figure 10 Power Meter Display



Item		
1	Display Controls Menu 	Used to configure the sensor and choose the format for displaying measurement data. See " <a href="#">Display Controls Menu</a> " on page 17.
2	Display Area/ Readings Menu	Displays the numerical readings available/selected device readings. The information on the readings menu can also be displayed in table or graphical format. See " <a href="#">Display Area</a> " on page 16.
3	Sensor Operations Menu 	Used to load Presets, select modes, send device commends, start Logging and share measurement results. See " <a href="#">Sensor Operations Menu</a> " on page 26 for detailed description of the available options.

---

## Display Area

---

### Readings Menu

Sensor measurements are displayed on the reading menu in a list format. The top reading is enlarged to aid visibility and an analog bar meter provides visual reference of the signal level.

**Graphical Displays** — Any readings may be displayed in graphical or tabular format by tapping the Display Controls Menu to display the graph options and selecting a graph from the list. See Graph Displays for additional information.

**Changing Units and Scale** — The analog bar meter is displayed with the top sensor reading, to provide a visual display of the measurement. The Analog Bar Meter's minimum and maximum scale value can be manually adjusted. See "[Changing Readings Menu Settings](#)" on page 16.

**Reorder Menu** — Any of the readings may be moved to the top of the list to ease reading. See "[Arranging the Readings Menu Order](#)" on page 17.

### Changing Readings Menu Settings

**Note:** *The Bird RF Power Meter Software will save all settings for each sensor (by serial number). Sensor specific settings will automatically load when the sensor is connected. All settings are saved in Session Files.*

The following changes can be made to any reading:

- Unit of measure
- Analog Bar Meter Scale

### Changing the Unit of Measure

1. Tap the sensor reading to display the popup dialog.
2. Tap Edit Unit.
3. Tap the measurement unit and select the new unit of measure from the drop down list.

### Changing the Analog Bar Meter Scale

1. Tap the sensor reading to display the popup dialog.
2. Tap Edit Meter Scale.
3. Tap the drop-down list and select Custom.
4. Enter the maximum value for the bar meter in the first text field.
5. Enter the minimum value for the bar meter in the second text field.
6. Select the unit of measure from the drop-down list for the value entered.

### Arranging the Readings Menu Order

The measurement type displayed at the top of the Readings Menu is selected by gesture.

1. Press the value until red border appears.
2. Drag the value up until it displaces the top value then release.

**Figure 11 Changing Readings Order**

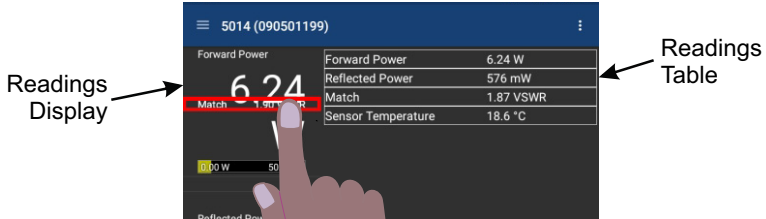

### Display Controls Menu

---

**Figure 12 Display Controls Menu**

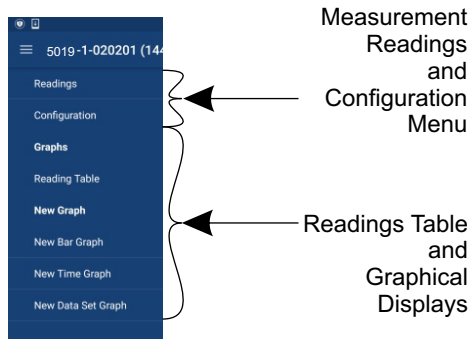

### Sensor Configuration Menu

**Input Offset** — Offset menu is used to enter the total value of all couplers and attenuators connected to the sensor (for example, the coupling factor of a directional coupler).

Tap Input Offset, enter the total attenuation of couplers and attenuators connected to the sensor then press OK.

**Smoothing** — Smoothing is a simple arithmetic mean calculated on the most recent (selected value) number of measurements. Smoothing is applied to the sensor data as it is received from the sensor.

Tap Smoothing, select radio button for desired value.

**Forward Scale** — Enter the watt rating of the forward element then press OK. See "[5014 Sensor Element Types](#)" on page 13 for information about the elements.



## Graph Displays

Any measurement can be displayed in graphical or tabular format. Several different graph types may be displayed.

Tap the Display Controls Menu  to display the graph options.

**Graph List** — Default options are Reading Table, New Bar Graph, New Time Graph, and New Data Set Graph (CCDF and Time Domain modes only). Any saved graph for the current sensor/mode will also be displayed on the list.

See "[How to Display a Graph](#)" on page 19.

**Reading Table** — The reading table displays all of the connected unit's measurements in a tabular format. The reading table will be displayed until a different option is selected.

## Graph Types

Any power measurement on the readings menu may be displayed on a graph. See "[How to Display a Graph](#)" on page 19. Graph setup may also be saved so frequently used settings will automatically be selected.

**Note:** *Graphs are saved for the mode only. If the mode is changed the saved graph will not be available, until the device/mode associated with the saved graph is reconnected. Graphs can be saved for other devices of the same type by saving a Default Preset.*

**Time Graph** — The time graph displays signal measurements over time. The x-axis displays the time of the reading, the y-axis displays the measurement value. The graph is limited to 2000 data collection points, once the graph reaches this limit the oldest data is discarded as new data is added, so the chart data will constantly be shifting to the left side of the screen. See "[Time Graph Controls](#)" on page 24 for detailed information on interacting with Time Graphs.

**Bar Graph** — The bar graph displays instantaneous power levels of one or more signal measurements. The x-axis displays the name of the reading, the y-axis displays the measurement value. The graph initial setting is a single bar, but additional bars may be added. See "[Bar Graph Controls](#)" on page 20 for detailed information on interacting with Bar Graphs.

**Data Graph** — Time Domain measurements are displayed on a Data Graph. The results are displayed following a measurement and continue to be displayed until a new scan is triggered. See "[Data Graph Controls](#)" on page 21 for detailed information on viewing Data Graphs.

**Note:** *Data Graphs are not available on all sensors.*

## How to Display a Graph

1. Tap the Display Controls Menu  to display the graph options.
2. Tap the name of graph type you wish to display (New Bar, New Time, New Data Set).

**Note:** *It is recommended a descriptive name be used as graph names, including graph type and other distinguishing information, since multiple graphs may be saved.*

3. Tap the name of the graph in the Create Graph Dialog a replace it with a descriptive name. See [Figure 13](#).

### Figure 13 Rename New Graph

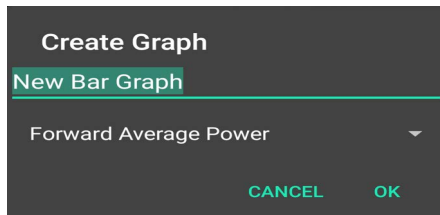

4. Select the measurement to graph from the drop-down menu.
5. Tap OK.
6. The new graph will be displayed in the Display Controls Menu below Reading Table.
7. Tap the graph's name in the menu to display the graph.

**Note:** *Graphs are saved for the current mode only. If mode is changed the saved graph will not be available until the mode associated with the saved graph is selected. Graphs can be saved by saving a Default Preset.*

**Note:** *Only the settings are saved, not the data. To save data see ["Logging" on page 27](#).*

## How to delete saved graphs

1. Tap the Display Controls Menu  to display the graph options.
2. Press the name of the graph in the list until the highlighted color changes, then tap the trash can symbol in the top right corner of the screen.

## Bar Graph Controls

**Note:** *Graph controls are located in the Sensor Operation Menu .*

### Pause/Resume

When pause is tapped, graph data collection is stopped and the bar is paused. When resume is tapped, data collection begins and bar begins moving.

### Graph Readings

The bar graph initially opens with only one measurement displayed, additional measurements may be displayed using this menu.

1. Tap the Sensor Operation Menu .
2. Tap Graph Readings to display the dialog.
3. Select as many of the listed measurements as desired.
4. Click OK after a check mark is displayed for all measurements you wish to display together on the graph.

### Graph Unit

The graph unit of measure may be changed manually by selecting a unit from the menu.

**Note:** *Changing the graph unit will automatically change the scale value.*

1. Tap the Sensor Operation Menu .
2. Tap Graph Unit to display the dialog.
3. Tap the radio button for the desired unit of measure.

### Graph Scale

The graph scale on the Y-axis may be changed by manually entering the minimum and maximum scale values.

1. Tap the Sensor Operation Menu .
2. Tap Graph Scale to display the dialog.
3. Tap drop-down list. Select Custom.
4. Tap the first value entry field (maximum) and enter the maximum scale value.
5. Tap the second value entry field (minimum) and enter the minimum scale value.
6. Tap the units drop-down list and select the appropriate value.
7. Click OK.

## Data Graph Controls

**Note:** *Graph controls are located in the Sensor Operation Menu .*

- Pinch the graph to zoom in or zoom out.
- Swipe up, down, left, or right to move the trace within the graph area.
- Tap Reset Zoom on the Sensor Operation Menu to return the graph to normal operation.

## Graph Unit

The graph unit of measure may be changed manually by selecting a unit from the menu.

**Note:** *Changing the graph unit will automatically change the scale value.*

1. Tap the Sensor Operation Menu .
2. Tap Graph Unit to display the dialog.
3. Tap the radio button for the desired unit of measure.

## Graph Scale

The graph scale on the Y-axis may be changed by manually entering the minimum and maximum scale values.

1. Tap the Sensor Operation Menu .
2. Tap Graph Scale to display the dialog.
3. Tap drop-down list. Select Custom.
4. Tap the first value entry field (maximum) and enter the maximum scale value.
5. Tap the second value entry field (minimum) and enter the minimum scale value.
6. Tap the units drop-down list and select the appropriate value.
7. Click OK.

## Add Marker

**Note:** *Markers are not available on Bar Graphs.*

1. Tap the Sensor Operation Menu .
2. Tap Add Marker.

When Add Marker is tapped, a marker is added at the center point of the graph. All markers are added at the center point of the graph, newly added markers will be positioned directly "over" previous markers if the previous marker has not moved from the center point. The value of the signal at the marker position may be displayed in a list.

## Marker List

1. Tap the Sensor Operation Menu .
2. Tap Marker List.

When Marker List is tapped, marker list is displayed on the screen to the right or below the chart. The marker list is removed from the screen by tapping Marker List a second time.

**Figure 14** *Marker List*

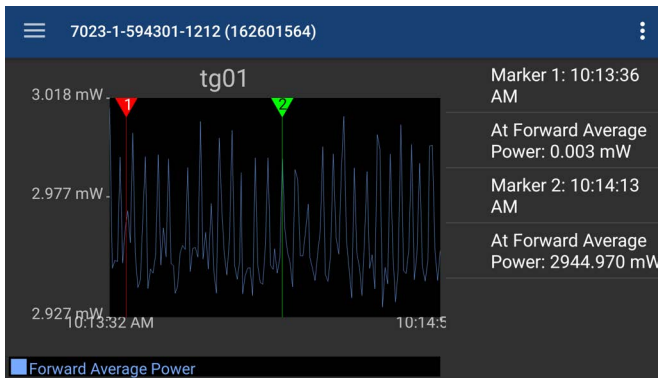

### Deleting Markers

Press the marker data in the marker list until Delete is displayed, then tap Delete.

**Figure 15** Delete Marker

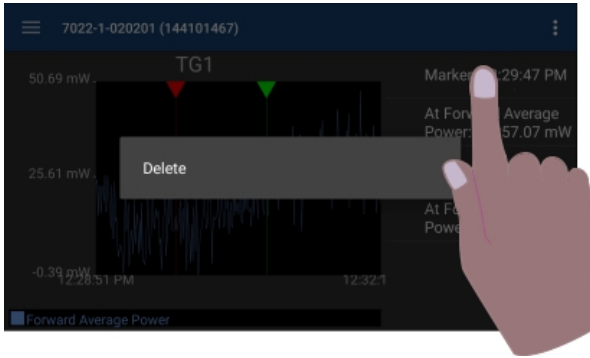



### Reset Zoom

when tapped, graph will be return to default view and the trace will update as data is collected.

## Time Graph Controls

Any measurement can be displayed in graphical or tabular format. See "[How to Display a Graph](#)" on page 19.

**Note:** *Graph controls are located in the Sensor Operation Menu* 

- Touching the graph area will stop the trace on the screen, however data will continue to be collected.
- Pinch the graph to zoom in or zoom out.
- Swipe up, down, left, or right to move the trace within the graph area.
- Tap Reset Zoom on the Sensor Operation Menu  to return the graph to normal operation.

## Pause/Resume

When pause is tapped, graph data collection is stopped and the trace is paused. When resume is tapped, data collection begins and trace begins moving.

## Graph Readings

The graph initially opens with only one measurement displayed, additional measurements may be displayed using this menu.

1. Tap the Sensor Operation Menu .
2. Tap Graph Readings to display the dialog.
3. Select as many of the listed measurements as desired.
4. Click OK after a check mark is displayed for all measurements you wish to display together on the graph.

## Graph Unit

The graph unit of measure may be changed manually by selecting a unit from the menu.

**Note:** *Changing the graph unit will automatically change the scale value.*

1. Tap the Sensor Operation Menu .
2. Tap Graph Unit to display the dialog.
3. Tap the radio button for the desired unit of measure.

## Graph Scale

The graph scale on the Y-axis may be changed by manually entering the minimum and maximum scale values.

1. Tap the Sensor Operation Menu .
2. Tap Graph Scale to display the dialog.
3. Tap drop-down list. Select Custom.
4. Tap the first value entry field (maximum) and enter the maximum scale value.
5. Tap the second value entry field (minimum) and enter the minimum scale value.
6. Tap the units drop-down list and select the appropriate value.
7. Click OK.

## Add Marker

1. Tap the Sensor Operation Menu .
2. Tap Add Marker.

When Add Marker is tapped, a marker is added at the center point of the graph. All markers are added at the center point of the graph, newly added markers will be positioned directly "over" previous markers if the previous marker has not moved from the center point. The value of the signal at the marker position may be displayed in a list.

## Marker List

1. Tap the Sensor Operation Menu .
2. Tap Marker List. See [Figure 14 on page 22](#).

When Marker List is tapped, marker list is displayed on the screen to the right or below the chart. The marker list is removed from the screen by tapping Marker List a second time.

## Deleting Markers

Press the marker data in the marker list until Delete is displayed, then tap Delete. See [Figure 15 on page 23](#).

## Reset Zoom

when tapped, graph will be return to default view and the trace will update as data is collected.



## Sensor Operations Menu

Figure 16 Sensor Operation Menu

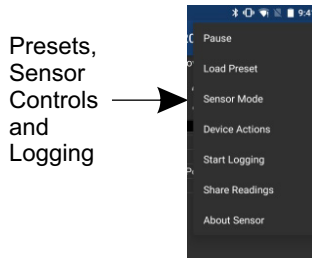

**Pause/Resume** — The Pause option will stop the updates of measurement readings and graphs.

**Load Preset** — This option allows you to load a preset configuration file, see Session Files for details.

**Device Actions** — There are no options on this menu for the 5014 Power Sensor.

**Start Logging** — The Start Logging function will log measurements to a text file.

**Note:** *Logging is Mode specific, if the sensor in use has multiple modes and the mode is changed, logging will automatically stop.*

1. Tap Start Logging to display the Logging Options Dialog Box, see Logging Interval and Logging Condition. The menu option will change to Stop Logging once logging is activated.
2. Once logging begins an Icon is displayed in the notification area on the android device.
3. Logging will continue until Stop Logging is tapped, on the Sensor Operations Menu .

**Note:** *If Logging Interval and Logging Condition are both checked. Logging will occur when the condition is met AND the interval has elapsed.*

**Logging Interval** — Logging Interval is used to set a repetitive time used to log all sensor measurements.

Enter a repeat time and select from seconds, minutes, or hours.

**Logging Condition** — Logging Condition is used to set a criteria for logging. Select a measurement and the criteria the measurement must meet or exceed for logging to take place.

**Viewing Logged Data** — The Log files are saved on the internal memory of the Android device. See Logging for details about the log files.

**Share Readings** — The Share Readings function will send a text report of the current measurement readings to a selectable destination via bluetooth. See ["Share Readings via Bluetooth" on page 29](#).

**About Sensor** — Displays the model number, serial number, and firmware version of the connected sensor.

## Logging

---

Sensor data can be logged by the Bird RF Power Meter Software. Logging saves all the sensors active readings into a text file. Logging can be started on the Sensor Operations Menu . Logs are saved using the following file naming convention:

**Figure 17 Log File Name Example**

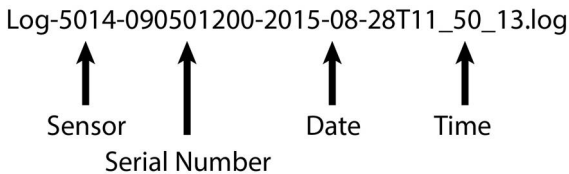

## Viewing Logged Data

The Log files are saved on the internal memory of the Android device.

Typical Path: SDCARD>Bird RF Meter>Logs.

The data is saved in JSON format in the log file. The data is broken into two sections and is shown below.

The data may be viewed as text in any text editor, or imported into a spreadsheet program. See [Importing Logs into Excel](#) for steps to import into Microsoft Excel.

## Log File Definition

**Section 1:** Data Definition, often referred to as an Object. The data logged will vary according to the sensor connected when the log file is created.

### Section 1 includes:

- Model, serial number, date and time log was created
- Readings definition
- Mode definition, including settings

**Section 2:** Data Array. The values recording in the log file are defined by the readings definition in section 1. Each array of values is prefaced by the word "results". Each log file will contain multiple data arrays, even hundreds or thousand depending on the length of time logging was allowed to run.

### Section 1 Example:

**Note:** *The format of the data has been altered in the example for simplification, the text runs together in log files.*

```
{
  "model": "BPMon002",
  "serialNumber": "Unknown",
  "created": "2015-09-09T15:55:40",
  "readings": [
    {
      "id": "Measurement.ForwardAveragePower",
      "name": "Forward Power",
      "readingType": "DoubleReading",
      "unit": "Unit.watts",
    },
    {
      "id": "Measurement.ReflectedAveragePower",
      "name": "Reflected Power",
      "readingType": "DoubleReading",
      "unit": "Unit.watts",
    },
    {
      "id": "Measurement.Match",
      "name": "Match",
      "readingType": "DoubleReading",
      "unit": "Unit.ReturnLoss",
    },
  ],
  "mode": "Mode.AveragePower",
  "settings": [
    {
      "id": "Configuration.AlarmSense",
      "name": "Alarm Sense",
      "value": "Configuration.Disabled",
    },
    {
      "id": "Configuration.AlarmEnable",
      "name": "Alarm Enable",
      "value": "Configuration.Enabled",
    },
    {
      "id": "Configuration.VSWRTripPoint",
      "name": "VSWR Trip Point",
      "value": "Configuration.VSWRTripPoint_1_5",
    },
  ],
}
```

### Section 2 Example:

**Note:** *The format of the data has been altered in the example for simplification, the text runs together in log files.*

```
{
  "results": [
    {
      "reading": "Measurement.ForwardAveragePower",
      "value": 25.5,
      "maxValue": 125,
      "status": "Normal",
    },
    {
      "reading": "Measurement.ReflectedAveragePower",
      "value": 0,
      "maxValue": 12.5,
      "status": "Normal",
    },
    {
      "reading": "Measurement.Match",
      "value": 0,
      "maxValue": null,
      "status": "Normal",
    },
    "timestamp": 1441814140972
  ],
  "results": [
    {
      "reading": "Measurement.ForwardAveragePower",
      "value": 25.5,
      "maxValue": 125,
      "status": "Normal",
    },
  ],
}
```

## Importing Logs into Excel

This procedure will display each group of results on one row with each measurement and values grouped by columns.

1. Transfer the log files to a PC.
2. Open an Excel spreadsheet.
3. Select Data Tab.
4. Click From Text on the menu. The Import Text File dialog box will open.
5. Select All Files, in the drop down menu at the bottom of the dialog box. Log files have the file extension .log.
6. Navigate to the folder containing the log file to import.
7. Select the file and click Import. This will open the Text Import Wizard.
8. On step 1, Select Delimited radio button, then click Next.
9. On step 2, select Comma and Other (add { }) as the delimiters, then click Next.
10. On step 3, click finish.

**Figure 18** Log File Open In Excel

results:	reading:"Measurement.ForwardAveragePower"	value:25.5	reading:"Measurement.ReflectedAveragePower"	value:0
results:	reading:"Measurement.ForwardAveragePower"	value:25.5	reading:"Measurement.ReflectedAveragePower"	value:0
results:	reading:"Measurement.ForwardAveragePower"	value:25.5	reading:"Measurement.ReflectedAveragePower"	value:0

**Note:** Columns have been removed in the example for simplicity.

## Share Readings via Bluetooth

---

Readings may be transferred from the 5000-NG using the following steps.

1. Prepare destination PC or Android device to receive Bluetooth
2. Verify Bluetooth is on. If off, see "[Starting and Stopping Communication Services](#)" on page 36.
3. Tap the Sensor Operation Menu 
4. Select Share Readings.
5. Tap Bluetooth
6. Select the Bluetooth device from the list.

**Figure 19** Share Readings

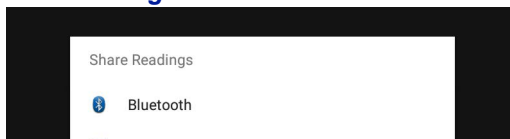

## Preferences Menu

Tap the menu icon  on the RF Meter device selection screen to display the Preferences menu.

**Figure 20** *Bird RF Meter Preferences Menu*

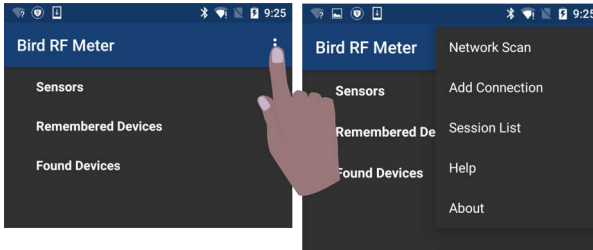

**Network Scan** — This menu option scans the WiFi network the android device is connected to for any Bird devices connected to the same network.

**Add Connection** — The menu is used to manually connect to a Bird Device on the WiFi network the android device is connected to.

**Session List** — This is a list of all session files saved from connecting to Bird Power Sensors. Session files are automatically created and saved for each sensor (by serial number) connected to the Bird RF Power Meter Software. For more information see "[Session Files](#)" on page 31.

**Help** — Displays this help documentation.

**About** — Displays copyright information and software source credits.

## Session Files

---

### Session List Definitions

Session files are used to initialize the Bird RF Power Meter Software when a Bird Power Sensor is connected. The following definitions describe the different session files.

**Figure 21** Session List

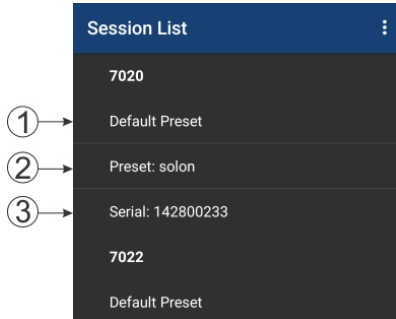

When a power sensor is connected to the Bird RF Meter the first time the Generic Session File (Default Preset if created) is used to initialize the App then a Serial Number Specific Session File is automatically created.

1. Default Preset: A menu option is provided that allows you to save a preferred setup as a Default Preset setup for all sensors of the same sensor type.
2. Preset: A Preset is similar to a Default Preset, the difference is the Preset must be manually loaded to be used.
3. Serial Number Specific Session File: When a power sensor is connected to the Bird RF Meter the first time the Generic Session File (Default Preset if created) is used to initialize the App then a Serial Number Specific Session File is automatically created. Any changes made to the configuration for the power sensor will be saved in the Serial Number Specific Session File (the Default Preset is NOT updated unless the menu option is used).
4. Generic Session File: (Generic Session Files do not appear in the Session List) The first time a Bird Power Sensor is connected to the Bird RF Power Meter Software the generic session file for that sensor type is used to initialize the software. The software will use default settings for the power sensor type.

### Open the Session List

1. Tap the menu icon  on the RF Meter device selection screen to display the Preferences menu.
2. Tap Session List on the menu.

## Save a Custom Configuration as a Default Preset

**Note:** *Your custom setup can be saved as a Default Preset session file. This allows the same custom setup to be viewed the first time you connect to the same type of Bird Power Sensor.*

1. Connect to a Bird Power Sensor.
2. Setup the User Interface to your preferred setup. The following are examples of custom setup items:
  - a. Save configurations for Graphs.
  - b. Organize the readings menu.
  - c. Configure the sensor.
  - d. Setup logging criteria.
3. Tap the Preferences menu  icon.
4. Tap Session List.
5. Press the session file for the device setup up above until the save menu is displayed.
6. Tap Save As.
7. Select Default Preset then tap OK.

**Note:** *You must delete any previous session files so your Default Preset will be used as the default Session File. This allows the same custom setup to be viewed every time you connect to the same type of Bird Power Sensor.*

## Edit Session File

Once a session file has been created, you can easily edit the session file even when not connected to the sensor.

1. Tap the Preferences menu  icon.
2. Tap Session List.
3. Press the session file until the menu is displayed.
4. Tap Edit Session.
5. Edit any settings just as if the sensor was connected, any changes will be automatically saved in the selected session file.

## Export Session File

When you connect to a Bird Power Sensor with the Bird RF Power Meter Software a Serial Number Specific Session File is created. You can also save your settings as the default settings for your power sensor type in a Default Preset or Preset. All of these file types can be exported from the Bird RF Power Meter Software for use on other devices.

1. Tap the Preferences menu  icon.



2. Tap Session List.
3. Press the session file for the device setup until the save menu is displayed.
4. Tap Export.
5. Rename the file if desired then click OK.

Exported Session Files are saved on the internal memory of the Android device and can then be transferred to a PC or another Android device.

Typical Path: SDCARD>Bird RF Meter>Sessions.

## Import Session File

If you wish to import one or more Session Files onto an Android device you must first copy the files onto the Android device into the Bird RF Meter folder.

1. Transfer the desired Session Files into the following folder on the destination Android device: SDCARD>Bird RF Meter>Sessions
2. Tap the Preferences menu  icon.
3. Tap Session List.
4. Tap the menu  icon in the Session List.
5. Tap Import Session.
6. Select the files for import in the Dialog Box (if no files are displayed, repeat step 1).
7. Tap OK

## Load a Session File

1. Connect a sensor.
2. Tap the Sensor Operation Menu .
3. Tap load preset.
4. Tap the session file to load from the list in the dialog box.

## Delete Session File

1. Open the Session List.
2. Press the Session File you wish to delete until the delete menu is displayed.
3. Tap Delete.



---

## 5000-NG Operating System User Interface

---

The Operating System User Interface provides access to the device settings and file explorer. Both of these services are password protected.

The password is **5000ng**.

- ["Camera" on page 34](#)
- ["Memory Expansion" on page 35](#)
- ["Eject Memory Device" on page 35](#)
- ["5000-NG Communications Settings" on page 36](#)
- ["Pairing a Bluetooth Device with the 5000-NG" on page 37](#)
- ["Connecting to a Wi-Fi Network" on page 38](#)

### Camera



---

A Camera App is not preinstalled on the 5000-NG, to use the camera the Camera App APK must be manually installed, see "[Package File \(APK\) Installation](#)" on [page 46](#).

The 5000NG\_Camera.apk is available on the 5000-NG product page on Bird's website.

<https://birdrf.com/Products/Sensors/RF-Power-Sensors/Digital-Power-Meter-Display/5000-NG-Digital-Power-Meter-Display.aspx>

### Camera Operation

1. Tap Home icon  on the 5000-NG display.
2. Tap the Apps icon  on the unit's home screen.
1. Tap the **Open Camera** Icon.
  - a. Pictures are stored in: Internal Memory/DCIM/OpenCamera
  - b. Detailed Operating Instructions can be found at <https://opencamera.org.uk/>

**Note:** *If the Open Camera Icon is not displayed then the 5000NG\_Camera.apk must be downloaded from the Bird website and manually installed, see "[Package File \(APK\) Installation](#)" on [page 46](#).*

## Memory Expansion

There are two options for extending the internal memory of the 5000-NG. There is a MicroSD slot and a USB port. While memory expansion is not required for proper operation of the 5000-NG, it provides a easy way to transfer information off of the power meter. Memory devices should be unmounted via software before being physically removed, see "[Eject Memory Device](#)" on [page 35](#).

## Eject Memory Device

This procedure should be performed to avoid corrupting the data stored on the external memory device.

1. Long Press the Home Icon.
2. Tap **Settings** on the menu. See [Figure 22](#).

**Figure 22 Settings Menu**

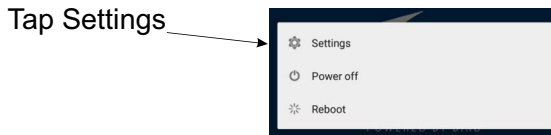

3. Type the password (5000ng) and tap confirm.
4. Tap **Storage**.

**Figure 23 Unmount Storage Device**

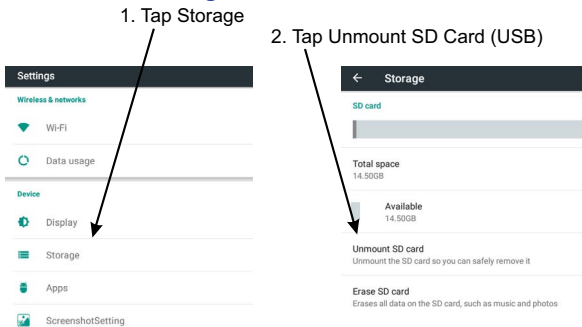

5. Scroll to **SD Card** or **USB Storage**
6. Tap the **Unmount** option.
7. Wait for unmount operation to complete.
8. Remove the storage device.

## 5000-NG Communications Settings

The 5000-NG utilizes Wi-Fi to perform functions described in the previous sections and Bluetooth can be used to transfer files from the 5000-NG to a PC.

These communications functions may be turned on and off using the 5000-NG's settings menus, See [Figure 24](#).

### Starting and Stopping Communication Services

1. Long press the power button.
2. Tap settings in popup menu.

**Figure 24 Settings Menu**

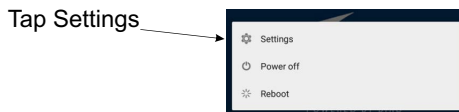

3. Type password (5000ng) and tap **Confirm**.
4. Tap the service Icon to start (or stop) the service, see [Figure 25](#).
  - a. WiFi: tapping Wi-Fi icon opens the Wi-Fi dialog. Tap the toggle on the upper right side of the screen to turn Wi-Fi on and off.
  - b. Bluetooth: tapping Bluetooth icon opens the Bluetooth dialog. Tap the toggle on the upper right side of the screen to turn Bluetooth on and off.

**Figure 25 5000-NG Communications Settings menus**

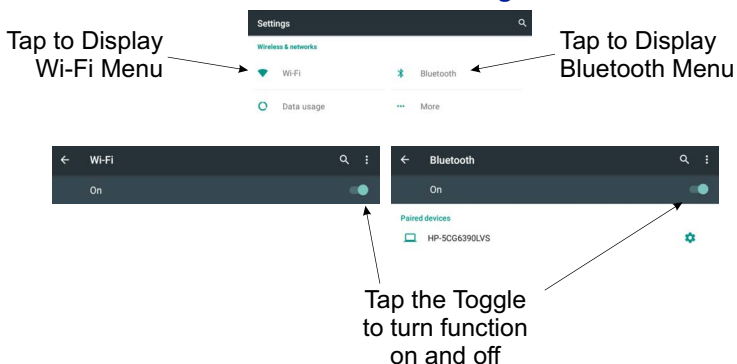

## Pairing a Bluetooth Device with the 5000-NG

---

### 5000-NG

1. Long press the power button.
2. Tap settings in popup menu.

**Figure 26** Settings Menu

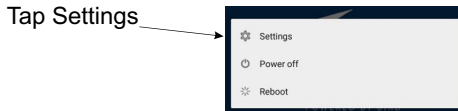

3. Type password (5000ng) and tap **Confirm**.
4. Tap Bluetooth icon to open the Bluetooth dialog.
5. If Bluetooth is off, tap the toggle to turn on.

**Note:** *A list of Bluetooth devices will be listed on the Bluetooth dialog. If the PC is not listed make sure Bluetooth on the PC is turned on.*

6. Tap the PC name in the list of available devices to pair it with the 5000-NG.

### Windows PC

**Note:** *A notification will appear on the PC, indicating the 5000-NG is attempting to pair with the PC.*

7. Click the **Add a Device** notification to pair the PC with the 5000-NG.
8. Verify the PIN number displayed on the PC matches the PIN number display on the 5000-NG.
9. Click **Yes** on the PC's pairing dialog box.

### 5000-NG

10. Tap Pair on the 5000-NG's pairing dialog box to complete the pairing process.

---

## Connecting to a Wi-Fi Network

---

1. Long press the power button.
2. Tap settings in popup menu.

**Figure 27 Settings Menu**

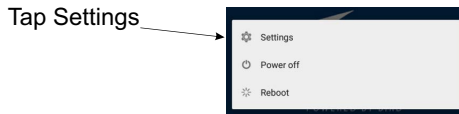

3. Type password (5000ng) and tap **Confirm**.
4. Tap Wi-Fi icon to open the Wi-Fi dialog.
5. If Wi-Fi is off, tap the toggle to turn on.

**Note:** *A list of Wi-Fi networks will be listed on the Wi-Fi dialog.*

6. Tap the name of the Wi-Fi network you want to connect 5000-NG with.
7. Type the network password into dialog box and tap **CONNECT**.

## File Transfers

---

File transfers from the 5000-NG may be accomplished using USB Drive, SD Card, USB Cable, or PC Bluetooth connection.



For instructions on how to make transfers see:

- ["Transfer Files from Internal Storage to USB Drive or MicroSD" on page 39](#)
- ["Transfer Files from the 5000-NG to a PC via USB Cable" on page 41](#)
- ["Transfer Files from 5000-NG to a PC using Bluetooth" on page 41](#)

### Transfer Files from Internal Storage to USB Drive or MicroSD

---

Files can be transferred from or to the 5000-NG internal memory with either a MicroSD Card or a USB drive.

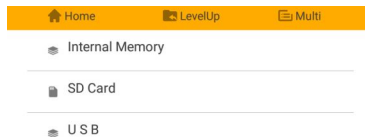

1. Connect one of the following to begin:
  - Insert a MicroSD card into the MicroSD slot
  - Connect the USB drive to the USB port on the 5000-NG.
2. Tap Home icon  on the 5000-NG display.
3. Tap the Apps icon  on the unit's home screen.
4. Tap the Explorer App.
5. Type the password (5000ng) and tap yes.
6. Navigate to the location of the file. See [Figure 28](#).  
Example: Internal Memory > Bird RF Meter > Logs

**Figure 28** Media Selection



**Note:** Log files must be renamed because they contain colons (:). Files containing certain special characters must be renamed.

7. Rename files as required, log files contain colons (:) and must be renamed.
  - a. Long press the file to be renamed.

- b. Tap rename in the pop-up menu.
  - c. Delete or replace special characters in the file name, or type a new file name.
  - d. Tap OK to finish.
8. If transferring multiple files:
    - a. Tap Multi  in the header. See [Figure 29](#).
    - b. Tap each file to copy.
    - c. Tap Editor .
    - d. Tap Copy.

### Figure 29 Multiple File Selection

Tap for Multi-file Selection



9. If transferring just one file:
  - a. Long press the file name.
  - b. Tap Copy.
10. Tap the Home Icon .
11. Tap Storage location for transfer:
  - SD Card
  - USB
12. Navigate to the directory where the file will be saved.
 

**Note:** To create a folder on an external drive, tap .
13. Tap Editor.
14. Tap the Paste.
15. Exit the File Manager.

## Transfer Files from the 5000-NG to a PC via USB Cable

### CAUTION

Ensure 5000-NG is fully charged using the supplied adapter before connection to a PC for file transfers.

Due to the amperage required to charge the 5000-NG, charging from a PC may damage that power source.

1. Connect USB cable between USB port on the 5000-NG and USB port on a PC.
2. On the PC, open the device (TT800V) in Windows Explorer.
3. Files may be copied directly to or from the 5000-NG's internal storage and connected a USB Drive or MicroSD card to the PC.

**Note:** *Log files and session logs generated by the Bird RF Power Meter Software are stored in the 5000-NG Internal storage in a folder titled Bird RF Meter.*

**Figure 30** Windows Explorer Display

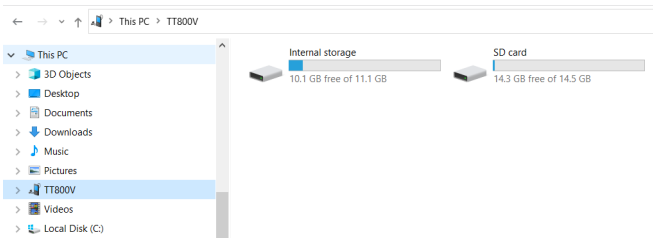

## Transfer Files from 5000-NG to a PC using Bluetooth

**Note:** *The PC and the 5000-NG must be paired prior to performing Bluetooth file transfers.*

**Note:** *These instructions are for a Windows 10 PC with Bluetooth capability, this process may be different on other operating systems.*



Files may be transferred to a Windows 10 PC using the following steps:

### Windows PC

1. Click on the Bluetooth icon on the PC's taskbar.
2. Select **Receive a File**.

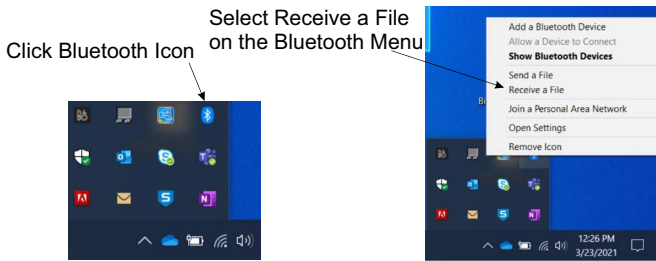

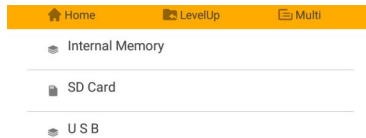

**Figure 31 PC Bluetooth Setup****5000-NG**

3. Tap Home icon  on the 5000-NG display.
4. Tap the Apps icon  on the unit's home screen.
5. Tap the Explorer App.
6. Type the password (5000ng) and tap yes.
7. Navigate to the location of the file. See [Figure 32](#).  
Example: Internal Memory > Bird RF Meter > Logs

**Figure 32 Media Selection**

**Note:** Log files must be renamed because they contain colons (:). Files containing certain special characters must be renamed.

8. Rename files as required, log files contain colons (:) and must be renamed.
  - a. Long press the file to be renamed.
  - b. Tap rename in the pop-up menu.
  - c. Delete or replace special characters in the file name, or type a new file name.
  - d. Tap OK to finish.
9. If transferring multiple files:
  - a. Tap Multi  in the header. See [Figure 29](#).
  - b. Tap each file to copy.
  - c. Tap Editor .
  - d. Tap Send.

**Figure 33 Multiple File Selection**

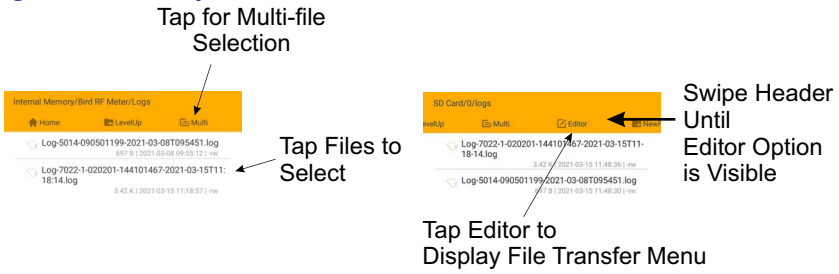

10. If transferring just one file:
  - a. Long press the file name.
  - b. Tap Send.
11. Tap the Bluetooth option in the Send Menu.
12. Tap the PC name in the Bluetooth Device Selection screen. See [Figure 34](#).

**Figure 34 Bluetooth Device selection**



## Windows PC

**Note:** The “Save the received file” dialog will appear on the PC once the files are received from the 5000-NG. See [Figure 35](#).

13. Click the **Browse..** button to select a location to save the files. Skip to use the default.

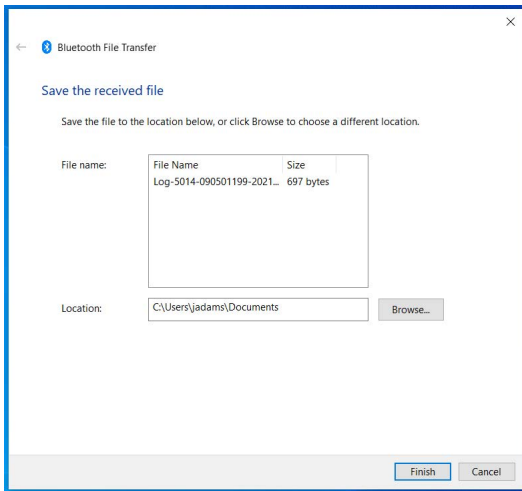
**Figure 35 Received File Dialog Box**

14. Click Finish to save the files on the PC in the selected location.

**Troubleshooting**

---

<b>PROBLEM</b>	<b>POSSIBLE CAUSE</b>	<b>REMEDY</b>
Nothing shown on DPM display	Unit is off or in sleep mode	Press and hold power key for approximately 3 seconds then release.
	Battery is drained	Use external power source. " <a href="#">Charging the DPM Battery</a> " on page 4.
Display does not show sensor model number when sensor is attached.	Sensor communication has failed	Check USB cable connections at sensor and DPM.
		Use a different cable.
		Use a different sensor.
Display shows bar scale is full	Unit is overrange	Use higher power elements (if applicable), or reduce RF power.
Erratic power readings	Element contact out of alignment	Align the contact. It must be far enough out to make good contact with the element, but must not restrict entry of the element body.
	Damaged element	Replace element.
	Sensor is damaged	Replace sensor.

**Cleaning**

---

**CAUTION**  
Do not use harsh or abrasive detergents for cleaning.

Clean the Bird Digital Power Meter and its display with a soft cloth dampened with mild detergent and water only. Clean sensors with a dry cleaning solvent that leaves no residue.

---

## DPM Maintenance

---

### Package File (APK) Installation

---



Package files (APK) are the format used to install apps on the 5000-NG. The RF Power Meter Software (and other applications provided by Bird) may be updated and made available on the 5000-NG product page on Bird's Website (birdrf.com).

To install an APK follow these steps:

#### PC

1. Download the APK from the Bird website to a PC.  
<https://birdrf.com/Products/Sensors/RF-Power-Sensors/Digital-Power-Meter-Display/5000-NG-Digital-Power-Meter-Display.aspx>
2. Unzip the file to obtain **5000NG\_xxxx.apk**  
**Note:** *Files may be transferred to the 5000-NG using a USB cable, SD Card, or USB Drive. Transfer via USB Drive is described in this procedure.*
3. Copy the file **5000NG\_xxxx.apk** to a USB drive.
4. Eject the drive from your PC.

#### 5000-NG

5. Power on the 5000-NG power meter display.
6. Insert the USB drive into the slot on the 5000-NG.
7. Press and hold the power button.
8. Tap **Settings** in the dialog box.
9. Type the password (5000ng) and tap **CONFIRM**.
10. Scroll down and tap **Security**.  
**Note:** *The Bird apps are not on the Google Play Store®, Installing Apps from Unknown Sources must be enabled to allow the Bird APK to be installed.*
11. Scroll down to **Unknown sources** and tap the switch to enable.  
Tap OK when the message is displayed.
12. Tap Home icon  on the 5000-NG display.
13. Tap the Apps icon  on the unit's home screen.
14. Tap the Explorer App.
15. Type the password (5000ng) and tap yes.
16. Tap USB, then USB\_DISK0, then udisk0
17. If necessary, navigate to the directory where the file was saved.
18. Tap the file name (**5000NG\_xxxx.apk**).
19. Tap **INSTALL** on the installation window.

**Figure 36** APK Installation Window

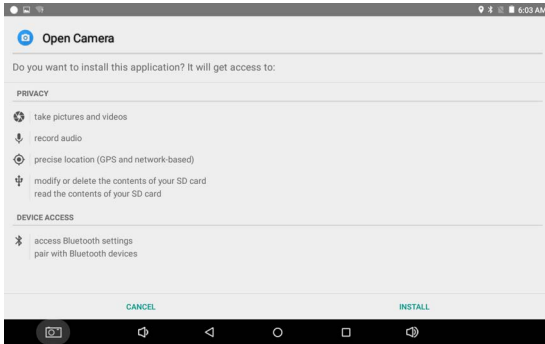

20. Once the installation is complete, tap **DONE**.
21. Press and hold the power button.
22. Tap **Settings** in the dialog box.
23. Type the password (5000ng) and tap **CONFIRM**.
24. Scroll down and tap **Security**.
25. Scroll down to **Unknown sources** and tap the switch to disable. Tap OK when the message is displayed.
26. Eject USB drive from 5000-NG, see "[Eject Memory Device](#)" on page 35.

## Storing the DPM

---

- Fully charge the battery prior to storing the unit.
- If the 5000-NG will be unused and unplugged from external power for more than 30 days, connect the charger to the unit every 30 days of storage.

## Customer Service

---

Any maintenance or service procedure beyond the scope of those in this chapter should be referred to a qualified service center.

If the unit needs to be returned for any reason, request a Return Material Authorization (RMA) through the Bird Technologies website. All instruments returned must be shipped prepaid and to the attention of the RMA number.

### Bird Service Center

30303 Aurora Road  
Cleveland (Solon), Ohio 44139-2794  
Fax: (440) 248-5426  
E-mail: [bsc@birdrf.com](mailto:bsc@birdrf.com)

For the location of the Sales Office nearest you, visit our Web site at:

<http://www.birdrf.com>

## Parts List

Figure 37 Supplied Items

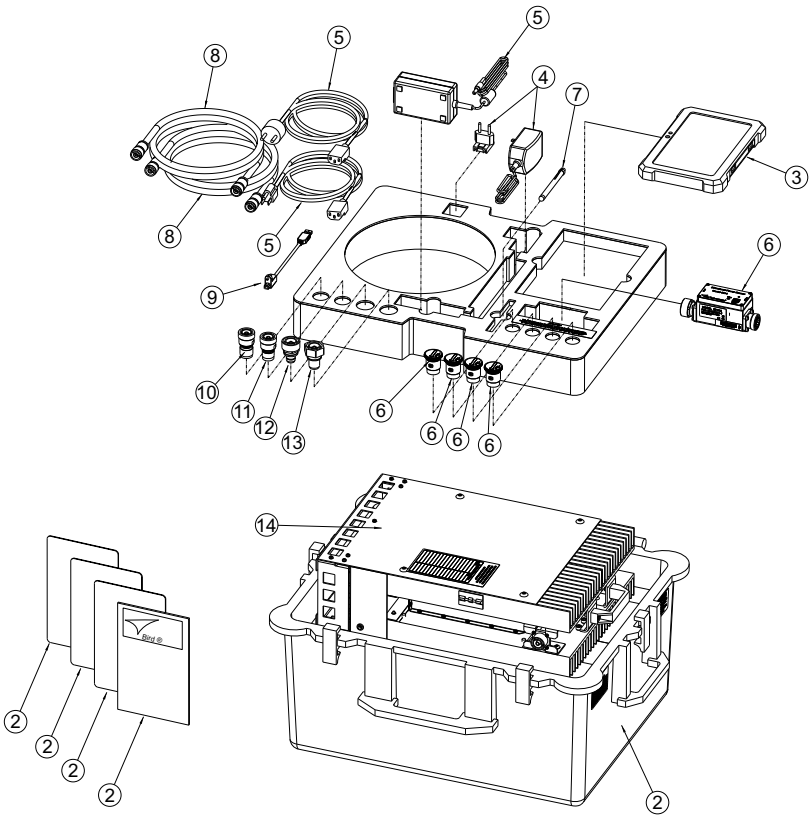

Index	Description	Bird P/N
	<b>Kit, Complete</b>	4300A750
2	<b>Case, including cards and manual</b>	4300B672-2
3	<b>Digital Power Meter</b> 5000-NG Digital Power Meter	5000-NG
4	<b>AC Adapter (5000-NG)</b>	5B5002-1
5	<b>AC Adapter (Load)</b>	5A2436
6	<b>5014M Directional Power Sensor, Elements, and Offset Card Kit</b>	5014M
7	<b>Stylus</b>	SK-TP-112
8	<b>Cables</b> 7/16 DIN (M) – 7/16 DIN (M), 6 ft (Two provided)	4300A676-8
9	<b>USB Cable, Meter/Sensor</b>	5A2653-6L
10 - 13	<b>Adapters</b> 7/16 DIN (F) – HN (M) 7/16 DIN (F) – N (M) 7/16 DIN (M) – HN (F) 7/16 DIN (M) – N (F)	4240-500-7 PA-MNFE 4240-500-9 PA-FNME
14	<b>8581A Forced-Air Cooled Load</b>	8581A200-1
	<b>Blank RF Sensor Dust Plug (Two provided)</b>	4230-022



## Color Codes

---

### Sensor Elements

---

Frequency Range	Color
30 – 60 MHz	Green
60 – 130 MHz	Blue

### Cables

---

Connectors	Color
7/16 DIN (M) – 7/16 DIN (M)	Red

## Specifications

---

### Overall Kit

---

<b>Frequency Range</b>	30 – 130 MHz
<b>RF Power</b> Average, Max. Peak, Max. Pulse Width, Max. Duty Cycle	2.2 kW 37 kW 10 ms Duty cycle such that average power rating is never exceeded
<b>AC Input</b>	120 ± 10% VAC @ 50/60 ± 3 Hz, single phase, current ≤ 10A. Output +15 VDC, 0 to 2.7A
<b>Maintenance Interval</b>	≥ 1 year
<b>Calibration Interval</b>	≤ 12 months
<b>Temperature</b> Operating Storage	5 to 40 °C (41 to 104 °F) –20 to +70 °C (–40 to +158 °F)
<b>Humidity, Relative</b> Operating Storage	30% to 75% 95% noncondensing max.

<b>Altitude, Above Sea Level (ASL)</b> Operating Storage	-984 to +11,800 ft ASL (-300 to +4000 m) -984 to +18,000 ft ASL (-300 to +5490 m)
<b>Dimensions, Nominal, Kit in Case</b>	21" x 15" x 25" (535 x 381 x 635 mm)
<b>Weight, Max, Kit in Case</b>	75 lbs (34.1 kg)
<b>Material</b>	No toxic materials Metals are corrosion resistant No sharp edges or projections on accessible components
<b>Acceleration, Max.</b>	± 1.5 G along any axis
<b>Magnetic Field, Max.</b>	500 G
<b>Acoustic Noise</b>	75 dBa max, 1m from external surfaces
<b>Compliance/Declaration of Conformity</b>	Directive 2014/30/EU relating to electromagnetic compatibility EN 61326-1 - Electrical equipment for measurement, control and laboratory use - EMC requirements - Part 1: General requirements 2014/35/EU Low Voltage Directive EN 61010-1 - Safety requirements for electrical equipment for measurement, control, and laboratory use - Part 1: General requirements EN 61010-2-30 - Safety requirements for electrical equipment for measurement, control, and laboratory use - Part 2-030: Particular requirements for testing and measuring circuits Restriction of Hazardous Substances (RoHS) Directive 2011/65/EU + (EU) 2015/863. UKEX(AKA UKCA): EN 61010-1:2010+A1:2019 BS EN IEC 61326-1:2021 EN 63000:2018
<b>Use Location</b>	Indoor Only
<b>Pollution Degree:</b>	2

## Meter (Model 5000-NG)

Display	Full-Color 8" 1280 x 800 pixel display with backlight.
Primary Display Functions (Sensor dependent)	True Average Power (Forward and Reflected)
	VSWR, Return Loss, rho, Match Efficiency
	IEEE 194 Pulse Parameters
	Sensor temperature.
Additional Functions	Data Logging, Numerical & Graphing display
Sensor Detection	Automatic
Storage	16 GB
Operating System	Android 5.1
Camera*	Front / Rear, 5MP, AF and Flash
Data Transfer	WiFi 802.11, USB Storage Device
Upgradability	Field firmware update-able via USB port.
Calibration Interval	No Calibration required (sensor calibration required)
Languages	English
Power	
Operating Power	Internal Battery, AC Adapter/Charger
Internal Battery	Rechargeable, 3.7V/6200 mAh lithium battery
Field Replaceable	No
AC Adapter/Charger	AC: 100-240V / 50-60Hz; DC: 5V/2.5A
Charge Indicator	Icon on display
Battery Life	Minimum 8 Hours continuous usage
	24 hour data logging (display in sleep mode)

\* Camera interface disabled from factory for security, user activation required.

**Sensor (Model 5014M)**

---

<b>RF Power Handling</b>	As specified under General Specification
<b>Frequency Range</b>	50 – 130 MHz, with additional calibration at specified freq and power levels
<b>Cal freq &amp; nominal power level</b> 127.72 MHz 63.86 MHz 51.70 MHz	35 kW, 25 kW, 4.5 kW, 3.3 kW 16 kW, 2 kW 8 kW, 4 kW, 2.5 kW
<b>Settling Time</b>	< 3 sec.
<b>Accuracy</b> General @ cal freq & power	± 8% ± 7½%
<b>Elements</b>	Only use Elements supplied with kit
<b>Connectors</b> Input Output	7/16 (M) 7/16 (F)
<b>Insertion VSWR, Max</b>	1.05:1
<b>Insertion Loss, Max</b>	0.1 dB
<b>Dynamic Range</b>	20 dB
<b>Dimensions, Nominal</b>	2.5" x 5.0" x 2.0" (64 x 127 x 51 mm)
<b>Weight, Nominal</b>	1.25 lb. (0.6 kg)

**Elements**

---

<b>Dynamic Range</b>	20 dB
<b>Labeling, Element</b>	Label lists max power (W)

**Cables**

---

<b>Connectors</b>	7/16 (M) to 7/16 (M)
<b>Material, 7/16 cable</b>	RG393
<b>Strain Relief</b>	30 lb. min.
<b>Length, 7/16, BNC to BNC</b>	6 ft

<b>Coiling</b>	Velcro wrap provided with each cable to keep it coiled while stored
<b>Labeling</b>	Color band at both ends indicates cable type. Label in middle lists P/N.

## Adapters

<b>Connectors</b>	7/16 (F) to HN (M) 7/16 (F) to N (M) 7/16 (M) to HN (F) 7/16 (M) to N (F)
-------------------	--

## Load (Model 8581A)

<b>Frequency Range</b>	10 – 130 MHz
<b>RF Power</b> Average, Max. Peak, Max. Pulse Width, Max. Duty Cycle	2.2 kW 37 kW 10 ms Duty cycle such that average power rating is never exceeded
<b>Impedance, Nominal</b>	50 ohm
<b>VSWR, Max.</b>	1.1:1
<b>VSWR Stability over 10 minute interval</b>	± 0.1 dB
<b>Connector</b>	7/16 (F)
<b>AC Input</b>	120 ± 10% VAC @ 50/60 ± 3 Hz, single phase, current ≤ 10A. Output +15 VDC, 0 to 2.7A
<b>Operating Position</b>	Vertical only
<b>Cooling method</b>	Forced air convection
<b>Dimensions, Nominal</b>	13" x 5.75" x 20.5" (330 x 145 x 521 mm)
<b>Weight, Max</b>	32 lb. (14.6 kg)
<b>Finish</b>	Black Powder Coat

# Limited Warranty

All products manufactured by Seller are warranted to be free from defects in material and workmanship for a period of one (1) year, unless otherwise specified, from date of shipment and to conform to applicable specifications, drawings, blueprints and/or samples. Seller's sole obligation under these warranties shall be to issue credit, repair or replace any item or part thereof which is proved to be other than as warranted; no allowance shall be made for any labor charges of Buyer for replacement of parts, adjustment or repairs, or any other work, unless such charges are authorized in advance by Seller.

If Seller's products are claimed to be defective in material or workmanship or not to conform to specifications, drawings, blueprints and/or samples, Seller shall, upon prompt notice thereof, either examine the products where they are located or issue shipping instructions for return to Seller (transportation-charges prepaid by Buyer). In the event any of our products are proved to be other than as warranted, transportation costs (cheapest way) to and from Seller's plant, will be borne by Seller and reimbursement or credit will be made for amounts so expended by Buyer. Every such claim for breach of these warranties shall be deemed to be waived by Buyer unless made in writing within ten (10) days from the date of discovery of the defect.

The above warranties shall not extend to any products or parts thereof which have been subjected to any misuse or neglect, damaged by accident, rendered defective by reason of improper installation or by the performance of repairs or alterations outside of our plant, and shall not apply to any goods or parts thereof furnished by Buyer or acquired from others at Buyer's request and/or to Buyer's specifications. Routine (regularly required) calibration is not covered under this limited warranty. In addition, Seller's warranties do not extend to the failure of tubes, transistors, fuses and batteries, or to other equipment and parts manufactured by others except to the extent of the original manufacturer's warranty to Seller.

The obligations under the foregoing warranties are limited to the precise terms thereof. These warranties provide exclusive remedies, expressly in lieu of all other remedies including claims for special or consequential damages. SELLER NEITHER MAKES NOR ASSUMES ANY OTHER WARRANTY WHATSOEVER, WHETHER EXPRESS, STATUTORY, OR IMPLIED, INCLUDING WARRANTIES OF MERCHANTABILITY AND FITNESS, AND NO PERSON IS AUTHORIZED TO ASSUME FOR SELLER ANY OBLIGATION OR LIABILITY NOT STRICTLY IN ACCORDANCE WITH THE FOREGOING.

