



SIGNALHAWK™
PC AND RACK MOUNT MODELS

OPERATIONS MANUAL
MODEL SH-36S-RM-ASL

© COPYRIGHT 2015 BY BIRD ELECTRONIC CORPORATION

INSTRUCTION BOOK PART NUMBER 920-36S-RM-ASL REV. A

SIGNALHAWK IS A TRADEMARK OF BIRD ELECTRONIC CORPORATION

MICROSOFT AND WINDOWS ARE REGISTERED TRADEMARKS OF THE MICROSOFT CORPORATION

ADOBE, ADOBE READER ARE REGISTERED TRADEMARKS OF ADOBE SYSTEMS INCORPORATED

Table of Contents

| | |
|---|----|
| Safety Precautions | 6 |
| Safety Symbols Used in this Documentation..... | 7 |
| Warning Statements | 8 |
| Caution Statements | 9 |
| Safety Statements..... | 10 |
| About This Manual..... | 13 |
| Changes to this Document..... | 13 |
| Document Contents | 13 |
| Introduction | 1 |
| Items Supplied | 2 |
| Controls, Indicators, and Connectors | 4 |
| Power Supply - PC SignalHawk..... | 7 |
| Power Supply - Rack Mount SignalHawk | 9 |
| Spectrum Analyzer Quick Start | 10 |
| Installation | 12 |
| PC SignalHawk Set-Up..... | 12 |
| Rack Mount SignalHawk Set-Up | 15 |
| Connecting the Rack Mount SignalHawk via USB Connection | 16 |
| Connecting Remotely via LAN/WAN Connection | 19 |
| Connecting a Remote Computer to the Host Computer | 24 |
| User Interface Menus and Settings | 26 |

| | |
|--|-----|
| Getting Started with the SignalHawk..... | 26 |
| Start Menu | 27 |
| Setup Menu..... | 29 |
| SignalHawk Spectrum Analyzer Screen Overview | 36 |
| Adv. Logging Menu | 80 |
| Advanced Spectrum Logging (ASL) | 80 |
| Adv. Logging — Database/Configuration Menu | 81 |
| Adv. Logging — Logging/Playback Menu..... | 83 |
| Sweep Logging Menu | 84 |
| Database Search Menu | 87 |
| Database Search Recall Playback Menu | 91 |
| Configuration Settings Dialog Box | 93 |
| Select Sweeps Dialog Box | 97 |
| Create Configuration File | 99 |
| Edit Configuration Files..... | 100 |
| Create a Database | 101 |
| Attach an Existing Database | 102 |
| Spectrum Trace Logging..... | 103 |
| Spectrum Trace Playback | 104 |
| Database Search | 104 |
| Recall Saved Database Search | 106 |
| Measurements | 107 |
| Spectrum Analysis Measurement..... | 108 |

| | |
|---|-----|
| Occupied Bandwidth Measurement | 109 |
| Channel Power Measurement | 111 |
| Adjacent Channel Power Measurement..... | 113 |
| Time Domain (Zero Span) Measurement | 115 |
| Field Strength Measurement | 117 |
| Demodulate Signal Measurement | 120 |
| Carrier-to-Interference Ratio Measurement | 122 |
| Out-of-Band and In-Band, Out-of-Channel Spurious..... | 125 |
| Utilities | 126 |
| Utility Menu | 126 |
| Customizing SignalHawk Content | 128 |
| Creating Database Search Limit Masks | 130 |
| ASL Report Generator | 132 |
| PC Tool | 135 |
| Downloading and Installing Software..... | 135 |
| Installing the PC Tool Software | 135 |
| Menu Bar..... | 136 |
| Tool Bar | 137 |
| Options Dialog Box (View>Options)..... | 140 |
| Maintenance | 146 |
| Cleaning..... | 146 |
| Charging PC SignalHawk Battery..... | 146 |
| Replace PC SignalHawk Battery | 146 |

Update PC SignalHawk Firmware 148

Update Rack Mount SignalHawk Firmware - Remotely 150

Troubleshooting..... 152

Customer Service 153

Specifications 153

Parts List..... 163

ROHS 166

Software License Terms 167

 MICROSOFT SOFTWARE LICENSE TERMS WINDOWS 7 PROFESSIONAL 167

 LIMITED WARRANTY 179

Limited Warranty 181

Safety Precautions

The following are general safety precautions that are not necessarily related to any specific part or procedure, and do not necessarily appear elsewhere in this publication. These precautions must be thoroughly understood and apply to all phases of operation and maintenance.

WARNING

Keep Away From Live Circuits

Operating Personnel must at all times observe general safety precautions. Do not replace components or make adjustments to the inside of the test equipment with the high voltage supply turned on. To avoid casualties, always remove power.

WARNING

Shock Hazard

Do not attempt to remove the RF transmission line while RF power is present.

WARNING

Do Not Service Or Adjust Alone

Under no circumstances should any person reach into an enclosure for the purpose of service or adjustment of equipment except in the presence of someone who is capable of rendering aid.

WARNING

Safety Earth Ground

An uninterruptible earth safety ground must be supplied from the main power source to test instruments. Grounding one conductor of a two conductor power cable is not sufficient protection. Serious injury or death can occur if this grounding is not properly supplied.

WARNING

Resuscitation

Personnel working with or near high voltages should be familiar with modern methods of resuscitation.

WARNING

Remove Power

Observe general safety precautions. Do not open the instrument with the power on.

Safety Symbols Used in this Documentation

WARNING

Warning notes call attention to a procedure, which if not correctly performed, could result in personal injury.

CAUTION

Caution notes call attention to a procedure, which if not correctly performed, could result in damage to the instrument.

NOTE

Calls attention to supplemental information.



The caution symbol appears on the equipment indicating there is important information in the instruction manual regarding that particular area.

Warning Statements

The following safety warnings appear in the text where there is danger to operating and maintenance personnel, and are repeated here for emphasis.

WARNING

When using the AC adapter, connect the AC plug only to a properly grounded receptacle. Serious injury or death can occur if not properly grounded..

See [AC Power Adapters](#).

WARNING

Care should be taken when handling batteries

- Keep out of the reach of children.
- Do not heat or dispose of batteries in fire. May burst or release toxic materials.
- Avoid forced discharge.
- Do not short circuit.
- Restrict charging current and time to the recommended value.
- Do not solder the battery directly.
- Do not disassemble, apply excessive pressure, or deform battery.
- Avoid placing the battery in reverse polarity.
- Battery disposal method should be in accordance with local and state regulations.

See [Maintenance](#).

Caution Statements

The following equipment cautions appear in the text whenever the equipment is in danger of damage and are repeated here for emphasis.

CAUTION

Spectrum Analyzer has a +20 dBm (100 mW) max. RF input. Exceeding the maximum input will damage the SignalHawk. If unsure of power levels, measure the test connection with a power sensor before using the SignalHawk.

See [Spectrum Analyzer Quick Start](#) and/or [Settings](#).

CAUTION

Do not block the fan airflow to prevent overheating.

See [Rack-Mount SignalHawk Set-Up](#).

CAUTION

Harsh or abrasive detergents, and some solvents, can damage the unit and labels.

See [Maintenance](#).

CAUTION

Replace battery pack with identical battery pack (4 or 6 Cell). Use only manufacturer supplied battery pack with the same number of cells as the battery being removed.

See [Maintenance](#).

Safety Statements

USAGE

ANY USE OF THIS INSTRUMENT IN A MANNER NOT SPECIFIED BY THE MANUFACTURER MAY IMPAIR THE INSTRUMENT'S SAFETY PROTECTION.

USO

EL USO DE ESTE INSTRUMENTO DE MANERA NO ESPECIFICADA POR EL FABRICANTE, PUEDE ANULAR LA PROTECCIÓN DE SEGURIDAD DEL INSTRUMENTO.

BENUTZUNG

WIRD DAS GERÄT AUF ANDERE WEISE VERWENDET ALS VOM HERSTELLER BESCHRIEBEN, KANN DIE GERÄTESICHERHEIT BEEINTRÄCHTIGT WERDEN.

UTILISATION

TOUTE UTILISATION DE CET INSTRUMENT QUI N'EST PAS EXPLICITEMENT PRÉVUE PAR LE FABRICANT PEUT ENDOMMAGER LE DISPOSITIF DE PROTECTION DE L'INSTRUMENT.

IMPIEGO

QUALORA QUESTO STRUMENTO VENISSE UTILIZZATO IN MODO DIVERSO DA COME SPECIFICATO DAL PRODUTTORE LA PROIZIONE DI SICUREZZA POTREBBE VENIRNE COMPROMESSA.

SERVICE

SERVICING INSTRUCTIONS ARE FOR USE BY SERVICE - TRAINED PERSONNEL ONLY. TO AVOID DANGEROUS ELECTRIC SHOCK, DO NOT PERFORM ANY SERVICING UNLESS QUALIFIED TO DO SO.

SERVICIO

LAS INSTRUCCIONES DE SERVICIO SON PARA USO EXCLUSIVO DEL PERSONAL DE SERVICIO CAPACITADO. PARA EVITAR EL PELIGRO DE DESCARGAS ELÉCTRICAS, NO REALICE NINGÚN SERVICIO A MENOS QUE ESTÉ CAPACITADO PARA HACERLO.

WARTUNG

ANWEISUNGEN FÜR DIE WARTUNG DES GERÄTES GELTEN NUR FÜR GESCHULTES FACHPERSONAL.

ZUR VERMEIDUNG GEFÄHRLICHE, ELEKTRISCHE SCHOCKS, SIND WARTUNGSARBEITEN AUSSCHLIEßLICH VON QUALIFIZIERTEM SERVICEPERSONAL DURCHZUFÜHREN.

ENTRETIEN

L'EMPLOI DES INSTRUCTIONS D'ENTRETIEN DOIT ÊTRE RÉSERVÉ AU PERSONNEL FORMÉ AUX OPÉRATIONS D'ENTRETIEN. POUR PRÉVENIR UN CHOC ÉLECTRIQUE DANGEREUX, NE PAS EFFECTUER D'ENTRETIEN SI L'ON N'A PAS ÉTÉ QUALIFIÉ POUR CE FAIRE.

ASSISTENZA TECNICA

LE ISTRUZIONI RELATIVE ALL'ASSISTENZA SONO PREVISTE ESCLUSIVAMENTE PER IL PERSONALE OPPORTUNAMENTE ADDESTRATO. PER EVITARE PERICOLOSE SCOSSE ELETTRICHE NON EFFETTUARE ALCUNA RIPARAZIONE A MENO CHE QUALIFICATI A FARLA.

UNITS ARE EQUIPPED WITH RECHARGEABLE BATTERIES.

THESE ARE TO BE REPLACED BY AUTHORIZED SERVICE PERSONNEL ONLY!!!

LAS UNIDADES VIENEN EQUIPADAS CON BATERIAS RECARGABLES.

¡¡¡Y SOLAMENTE EL PERSONAL DE SERVICIO AUTORIZADO PUEDE REEMPLAZARLAS!!!

GERÄTE SIND MIT WIEDER AUFLADBAREN BATTERIEN BESTÜCKT.

BATTERIEN SIND NUR VON QUALIFIZIERTEM SERVICE PERSONAL AUSZUWECHSELN!!!

CES DISPOSITIFS SONT ÉQUIPÉS DE BATTERIES RECHARGEABLES.

SEUL LE PERSONNEL D'ENTRETIEN AUTORISÉ EST HABILITÉ À LES REMPLACER!

LE UNITÀ SONO DOTATE DI BATTERIE RICARICABILI,

CHE DEVONO DA COME SPECIFICATO DAL PRODUTTORE LA PROTEZIONE DI SICUREZZA
POTREBBE VENIRNE COMPROMESSA.

USE CORRECT VOLTAGE SETTING AND FUSE - SEE MANUAL.

UTILISER UNE TENSION ET UN FUSIBLE CORRECTS - CONSULTER LE MODE D'EMPLOI.

USE LA INSTALACION Y FUSIBLE DE VOLTAJE CORRECTO - VEA EL MANUAL.

AUSSCHLIESSLICH VORSCHRIFTSMÄSSIGE WECHSELSPANNUNGS-EINSTELLUNG UND
SICHERUNG BENUTZEN - SIEHE DAZU HANDBUCH.

UTILIZZARE TENSIONE E FUSIBLE ADATTI - FARE RIFERIMENTO AL MANUALE.

About This Manual

This manual covers the operating and maintenance instructions for the following models:

SH-36S-RM-ASL

Changes to this Document

We have made every effort to ensure this manual is accurate. If you discover any errors, or if you have suggestions for improving this manual, please send your comments to our Solon, Ohio factory. This manual may be periodically updated. When inquiring about updates to this manual use the following information:

Part Number: 920-36S-RM-ASL Revision: A

Document Contents

| | |
|--|---|
| Introduction | Describes the features of the Bird SignalHawk, lists equipment supplied, introduces the controls and indicators, explains power sources, and provides quick start instructions. |
| Installation | Describes how to install and configure the SignalHawk PC and Rack Mount systems and connect SignalHawk to the user's systems. |
| User Interface Menus and Settings | Describes the screens and menus of the User interface. |
| Advanced Spectrum Logging | Describes how to log SignalHawk traces, play them back, and perform searches for spectrum anomalies. |
| Measurements | Describes the automated measurement features of the SignalHawk. Describes the steps required to perform each available measurement. |
| Utilities | Describes the utility menu, customizing SignalHawk menu features, and exporting data using ASL Report Generator. |

PC Tool

Describes Bird's SignalHawk PC Tool which allows the use of a user's PC to store measurement data, transfer it between units, and do individual analysis.

Maintenance

Lists routine maintenance tasks as well as troubleshooting for common problems. System specifications, parts information, and optional accessories are included in this section.

Introduction

The SignalHawk is a multifunction test instrument for use in the installation and maintenance of Radio Frequency (RF) and wireless systems. The model number is identified on the unit and also on the display screen at the end of the power-on sequence.

The firmware installed on the SignalHawk is updated on a regular basis. The operator's manual covers the most recent upgrade to the firmware up to the date listed on the manual. [See Troubleshooting.](#)

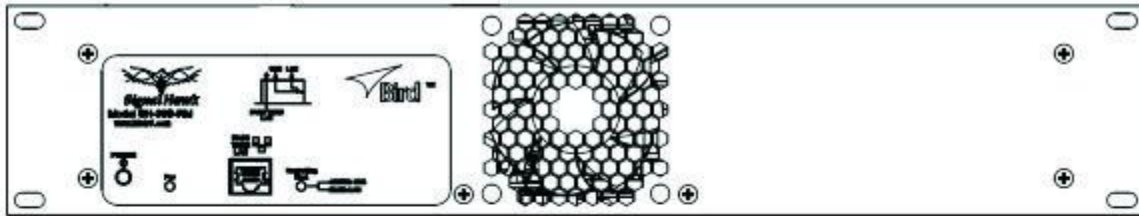

Rack-Mount SignalHawk

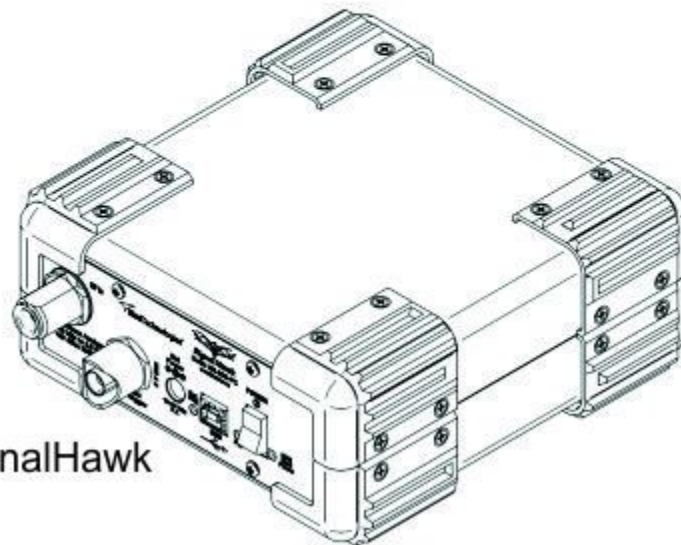

PC SignalHawk

Items Supplied

PC SignalHawk - Hardware and Software Supplied

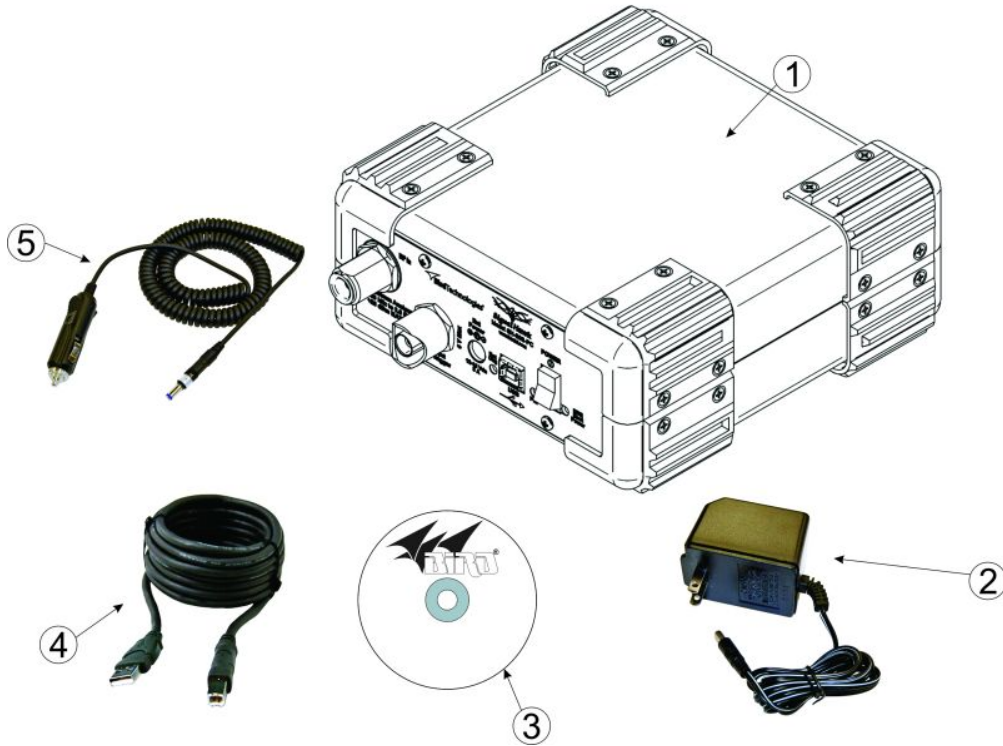

| Item | Description |
|------|---------------------------|
| 1 | PC SignalHawk |
| 2 | AC Power Adapter and Cord |
| 3 | Software CD |
| 4 | USB Cable |
| 5 | Car Adapter Cable |

Rack-Mount SignalHawk - Hardware and Software Supplied

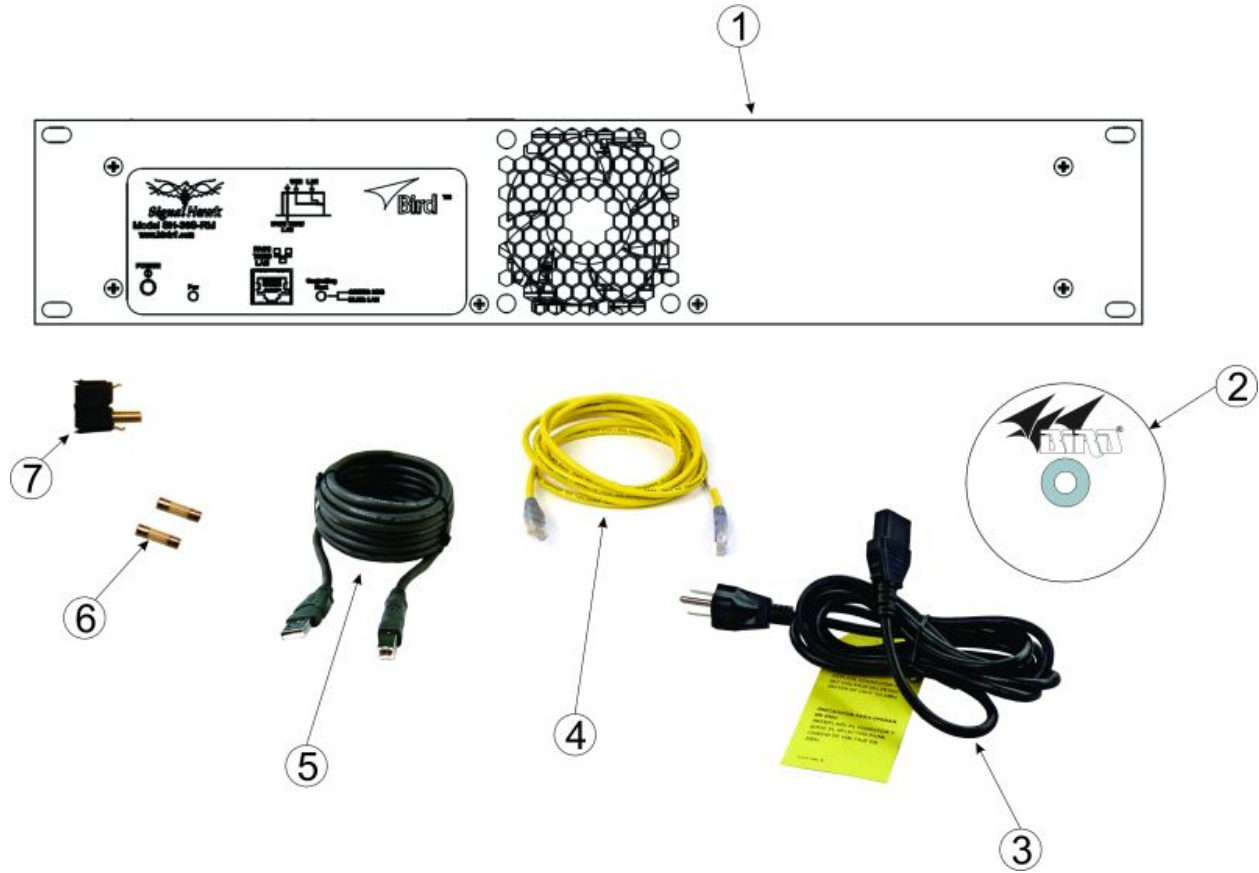

| Item | Description |
|------|---------------------------------|
| 1 | Rack-Mount SignalHawk |
| 2 | Software CD |
| 3 | AC Power Cord |
| 4 | Ethernet Cable |
| 5 | USB Cable |
| 6 | 2 SLO-BLO 5mm x 20mm .63A Fuses |
| 7 | Fuse Drawer with Shorting Bar |

Controls, Indicators, and Connectors

PC SignalHawk - Controls and Indicators



| Item | Description |
|------|---|
| 1 | USB Host Power Indicator |
| 2 | Power Switch |
| 3 | Charge Indicator Light |
| 4 | USB Type B for PC connection |
| 5 | Battery Charge Indicator |
| 6 | 2.1mm DC jack for external power supplies |
| 7 | BNC(F) external trigger input, 5V TTL |
| 8 | Spectrum Analyzer Port, N(F) RF input, +20 dBm max. |

Rack-Mount SignalHawk - Controls and Indicators

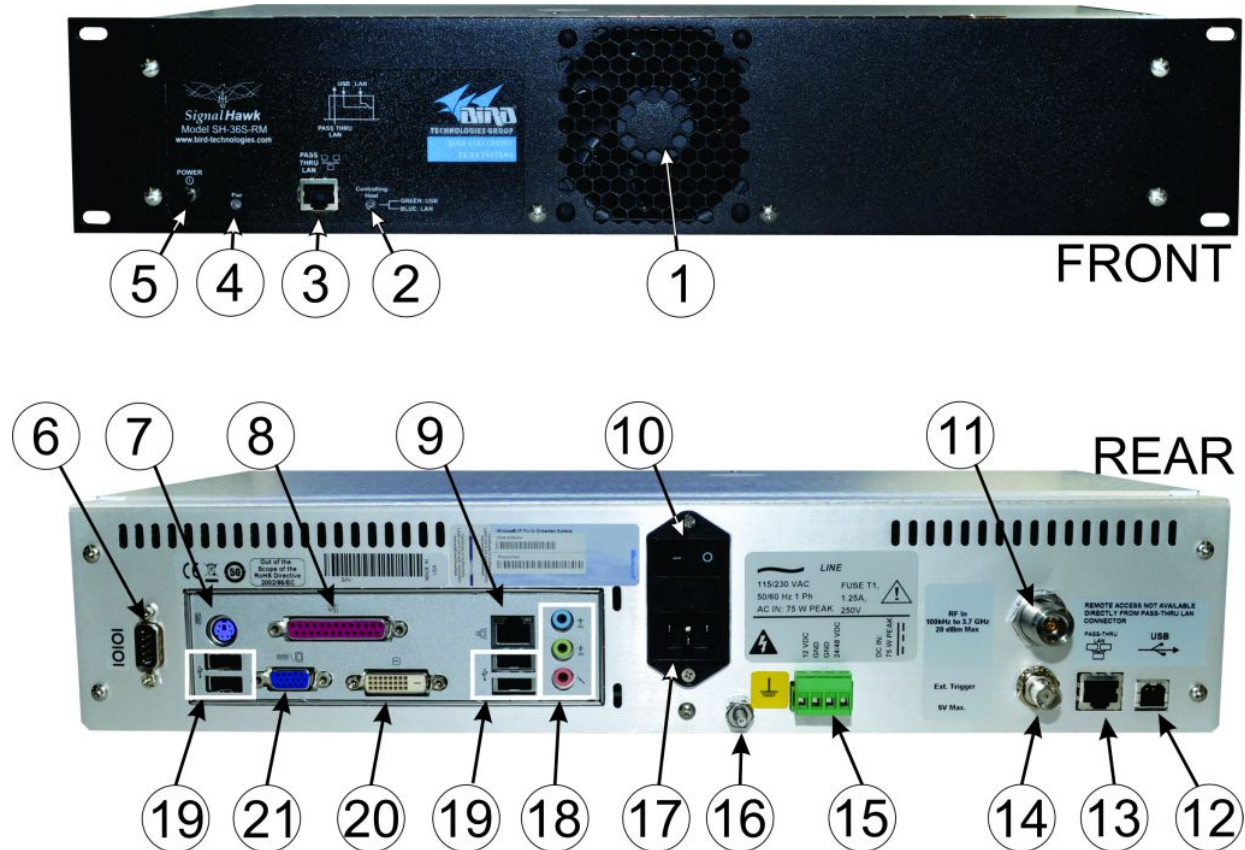

| Item | Description |
|------|---|
| 1 | Fan |
| 2 | Controlling Host Indicator. Green: USB, Blue: LAN. |
| 3 | Pass-Thru LAN Connector (provided for Laptop connection to the LAN) |
| 4 | Power Indicator |
| 5 | Power Push button |
| 6 | RS-232 Connector |
| 7 | PS/2 Connector |
| 8 | Parallel Port |
| 9 | LAN Connector |
| 10 | AC Power Switch |
| 11 | Spectrum Analyzer Port, N(F) RF input, +20 dBm max. |
| 12 | USB Type B for PC connector |
| 13 | Pass-Thru LAN Connector (provided for Laptop connection on the front panel) |
| 14 | BNC(F) external trigger input, 5V TTL |
| 15 | External 12/24/48 VDC Connector |

| | |
|----|---------------------------|
| 16 | Ground Post |
| 17 | AC Power connector |
| 18 | Audio connectors |
| 19 | USB connectors (2 Places) |
| 20 | DVI display connector |
| 21 | VGA display connector |

Power Supply - PC SignalHawk

Internal Battery

The PC SignalHawk has an internal, rechargeable, lithium-ion battery pack that will operate the unit for a minimum of 3 hours of continuous use. Recharging time, from a full discharge, is approximately 4 hours.

NOTE

When the unit is shipped from the factory, the battery may not be fully charged. Use an AC adapter when operating the unit for the first time.

AC Power Adapters

| |
|--|
| <p style="text-align: center;">WARNING</p> <p style="text-align: center;">When using the AC adapter, connect the AC plug only to a properly grounded receptacle. Serious injury or death can occur if not properly grounded..</p> |
|--|

The PC SignalHawk can be operated using the supplied AC adapter or a 12V automobile cigarette lighter adapter. Using these adapters will also charge the internal battery.

NOTE

The charge LED will be steady amber while charging and steady green when fully charged.

Charge Indicator Light

The charge indicator light on the PC SignalHawk has a dual function.

| Power Source | Indicator Color | Condition |
|----------------|-----------------|-----------------------------|
| External Power | Amber | Charging battery |
| | Green | Battery fully charged |
| Battery Power | Off | 100% to 30% Power Available |
| | Amber | Below 30% Power Available |

When the amber light comes on, the PC SignalHawk has approximately 1 to 1.5 hrs of operation left depending on temperature and battery age. At this time, the unit should be charged or the battery should be replaced. See [Charging PC SignalHawk Battery](#) or [Replace PC SignalHawk Battery](#).

NOTE

To avoid damage to the battery pack, the unit will shut-off completely when the battery charge falls below 10%. If this occurs, the battery must be charged to a minimum voltage before the unit is allowed to resume operation. Full recharging is recommended.

Power Supply - Rack Mount SignalHawk

AC Power Connector

The AC Power connector provides operating power for the Rack Mount Signal-Hawk. The AC power supply cord is also the line disconnect device for this product. Use the supplied AC power cord or an approved power cord to connect to the Rack Mount SignalHawk, such as domestic type SVT, 300 VAC, 18 AWG, 10 A, 3 conductor (including ground) or international type H05VV-F, 300 VAC, 1.00 mm, 10 A, 3 conductor (including ground).

NOTE

The Rack Mount SignalHawk is shipped from the factory configured for 110VAC operation, 2-pole fuse (fused line and neutral).

If the Rack Mount SignalHawk will be installed with 220VAC supply, follow these instructions:

1. Remove the fuse drawer from the power entry module on the rear of the unit.
2. Remove fuses from drawer & set aside.

NOTE

There are two different fuse drawers supplied with the Rack Mount SignalHawk. One is a 2-pole fuse tray (fuse on both lines) the other is a single fuse tray (line fuse, shorting bar on neutral). Check with local regulations to determine whether single or dual pole fuse protection is required.

3. Install one or both fuses into the appropriate fuse drawer:
 - 110VAC operation: 5x20mm SLO BLO 1.25A
 - 220VAC operation: 5x20mm SLO BLO 0.63A
4. Insert fuse drawer into the power entry module.
5. Insert AC power cord into the IEC receptacle on the power entry module.

DC Supply

The Rack-Mount SignalHawk can also be powered by a direct DC voltage wired into the terminal lugs on the rear of the unit. This is useful if the installation site has DC power readily available or it can be connected in addition to the AC power if the DC source is part of a battery back-up system. There are two separate DC power inputs on the terminal connector. The combination of the two allows a wide range of DC voltage sources. Refer to the specifications page for voltage range and current requirements.

NOTE

Ensure proper polarity is observed on the DC supply and input voltage is connected to the correct pair of terminal lugs.

Spectrum Analyzer Quick Start

CAUTION

Spectrum Analyzer has a +20 dBm (100 mW) max. RF input. Exceeding the maximum input will damage the SignalHawk. If unsure of power levels, measure the test connection with a power sensor before using the SignalHawk.

1. Measure the output power, or signal power, at the system's test port using a power meter, service monitor, or equivalent.

NOTE

Ensure the output power is less than +20 dBm (100 mW).

2. Connect the SignalHawk's "RF Input" connector:
 - For low-power connections, connect directly to the output of the signal source.

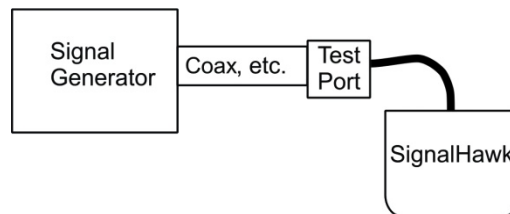

- For high-power connections, use a directional coupler or attenuator to reduce the output level of the signal source.

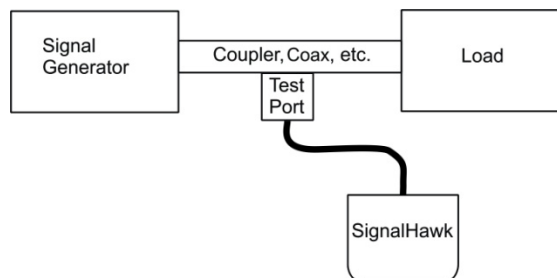

3. Power up the SignalHawk.
4. In the Start Menu, click on Spec Analysis then click the Enter button (see [Start Menu](#)).
5. In the Freq & Span Menu, set the frequency range (see [Freq & Span Menu](#)).
6. In the Amplitude Menu, click on AutoScale after the first sweep. (see [Ampt & Trace Menu](#)).

7. In the Start menu, select the desired measurement.
 - [Spectrum Analysis Measurement](#)
 - [Occupied Bandwidth Measurement](#)
 - [Channel Power Measurement](#)
 - [Adjacent Channel Power Measurement](#)
 - [Time Domain \(Zero Span\) Measurement](#)
 - [Field Strength Measurement](#)
 - [Demodulate Signal Measurement](#)
 - [Carrier-to-Interference Ratio Measurement](#)
8. Turn on markers or limit lines if needed (see [Mark & Limit Menu](#)).
9. Make a sweep.
10. In the File & Help Menu, click on Quick Save Trace to save the data (see [File & Help Menu](#)).

Installation

PC SignalHawk Set-Up

Installing the SignalHawk Program

NOTE

Install the PC software before connecting the PC SignalHawk for the first time.

1. Insert installation CD.
2. Select Install Software when prompted.

NOTE

Set-up will inspect the computer for any missing operating system prerequisites. If all are present, skip to step 6

3. Select "Next" and the install utility begins the Prerequisites Installation process.
4. Review the End-User License Agreement, check "I accept the terms of the License Agreement" and select "Install."

NOTE

- The install Utility will install the prerequisites. This may take several minutes.
 - When completed, check with Microsoft support center for any security updates. Typically, if "Automatic Updates" are configured on the host PC, these will be automatically flagged and selected for download and installation.
 - The installation utility will launch after the OS prerequisites are installed.
5. Select installation directory by doing one of the following:
 - Accept the default installation location.
 - Select a different folder.
 6. Select "Next" and the installer will complete.
 7. Select "Finish" to launch the SignalHawk program.
 8. Connect PC SignalHawk to a PC using the supplied USB cable.

NOTE

The "USB Host Power" LED will illuminate when the host port is active and has power. It is not an indication of proper USB connectivity to the host.

9. Turn power on.

10. Select “Install the software automatically” in the Found New Hardware Wizard window.

Found New Hardware Wizard



11. Click “Next”.
12. Follow the instructions that are presented.
13. Click “Finish” in the Completing the Found New Hardware Wizard window.

Completing the Found New Hardware Wizard



14. Launch the SignalHawk program.

NOTE

PC SignalHawk can be used in any orientation.

- 15. Select the unit from the DSP Device List, if necessary.
- 16. Connect RF signal.
- 17. Connect a TTL trigger source to the BNC connector, if necessary.

Select DSP Device List

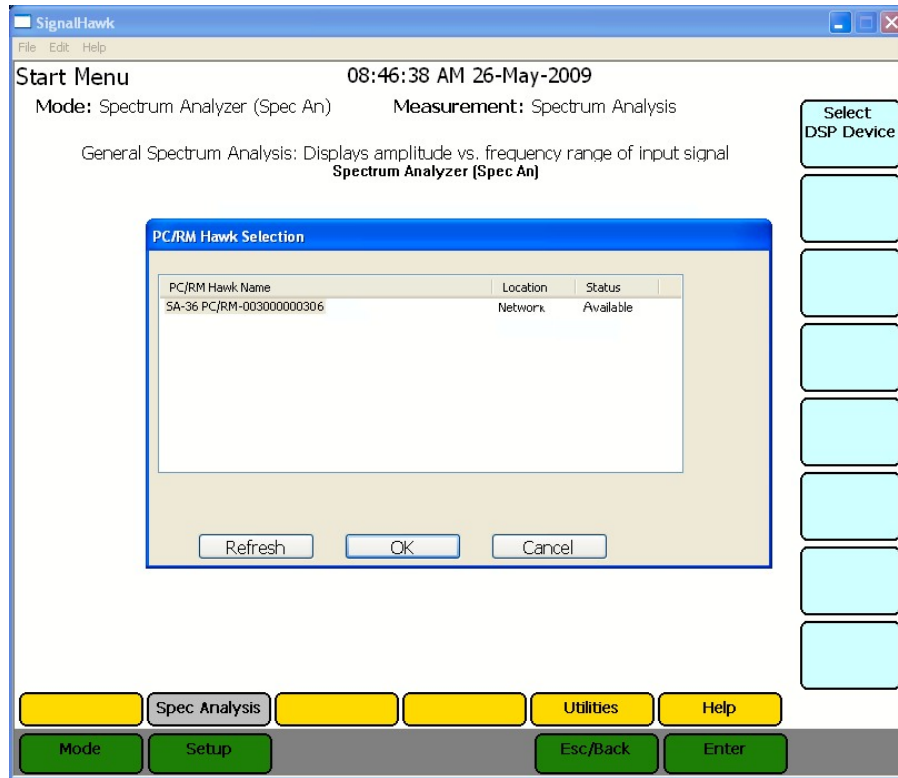

Rack Mount SignalHawk Set-Up

Installing the Rack Mount SignalHawk into a Rack

CAUTION

Do not block the fan airflow to prevent overheating.

The Rack Mount SignalHawk is a short-depth, 2 rack-unit (RU) device designed for installation into standard 19" equipment test racks. It can also be used free-standing. Use installation hardware available for the rack to mount the SignalHawk.

NOTE

For maximum stability, use four screws to secure the Rack Mount SignalHawk into the rack.

CAUTION

Avoid installing the Rack Mount SignalHawk near equipment that exhausts or radiates excessive heat (such as power amplifiers or DC power supplies). Proper ventilation should always be considered as part of the installation location.

1. Install the Rack Mount SignalHawk into the equipment or test rack.

Installing the Rack Mount SignalHawk

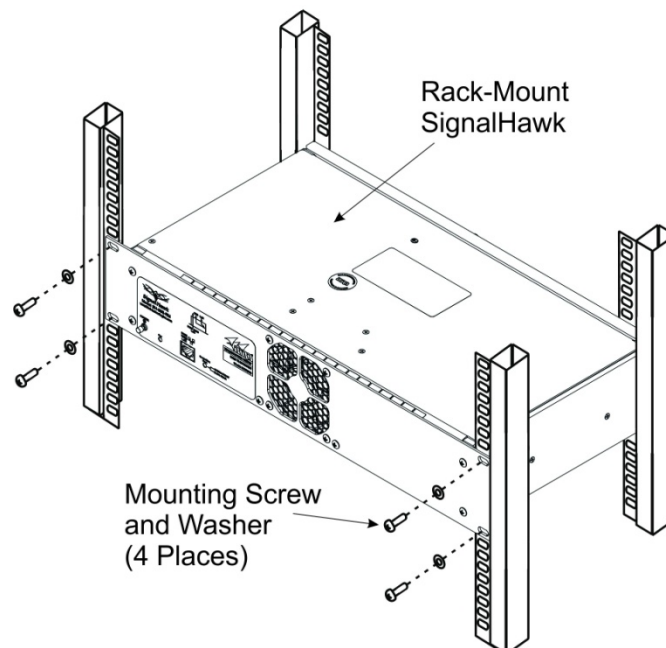

2. Connect proper power supply. See [Power Supply - Rack Mount SignalHawk](#).

3. Connect the Rack Mount SignalHawk to a host PC through one of the following:
 - Rear USB
 - Rear LAN (left side)

NOTE

- There are three RJ45 (Ethernet) jacks on the unit. Use the rear LAN connection jack for remote access. See [Rack Mount SignalHawk Connection Diagram](#).
- Host control priority is given in the order shown above.

Example - If the normal remote connection is via a Rear LAN connection, and the Rear USB is connected to a local host the remote LAN connection will be disconnected & the local host connection will be allowed control. The remote LAN connection will be restored upon disconnection from the local host.

4. Connect the rear “Pass-thru LAN” RJ45 jack to an on-site router or hub.

NOTE

This enables convenient, local connection to a network, via the front panel “Pass-thru LAN” RJ45 jack while on-site, without having to have physical access to an on-site hub.

Connecting the Rack Mount SignalHawk via USB Connection

NOTE

Install the PC software before connecting the Rack Mount SignalHawk for the first time.

1. Insert installation CD into host PC.
2. Select Install Software when prompted.

NOTE

Set-up will inspect the computer for any missing operating system prerequisites. If all are present, skip to step 4.

3. Select “Next” and the install utility begins the Prerequisites Installation process.
4. Review the End-User License Agreement, check “I accept the terms of the License Agreement” and select “Install.”

NOTE

- The install utility will install the prerequisites. This may take several minutes.
- When completed, check with Microsoft support center for any security updates. Typically, if “Automatic Updates” are configured on the host PC, these will be automatically flagged and selected for download and installation.
- The installation utility will launch after the OS prerequisites are installed.

5. To select installation location do one of the following:
 - Accept the default installation location.
 - Select a different folder.
6. Select “Next” and the installer will complete.
7. Select “Finish” to launch the SignalHawk program.
8. Connect Rack Mount SignalHawk to a PC using the supplied USB cable.

NOTE

The “Controlling Host” LED will illuminate green when host port is active and has power. It is not an indication of proper USB connectivity to the host.

9. Turn power on.
10. Select “Install the software automatically” in the Found New Hardware Wizard window.

NOTE

This procedure is performed when connecting either a PC or Rack Mount SignalHawk for the first time. Driver installation is required for every distinct SH-36S-PC or SH- 36S-RM connected to the computer.

Found New Hardware Wizard



11. Click “Next”.
12. Follow the instructions that are presented.

13. Click “Finish” in the Completing the Found New Hardware Wizard window.

Completing the Found New Hardware Wizard



14. Launch the SignalHawk program.

15. Select the SignalHawk unit from the Select DSP Device list.

Select DSP Device list

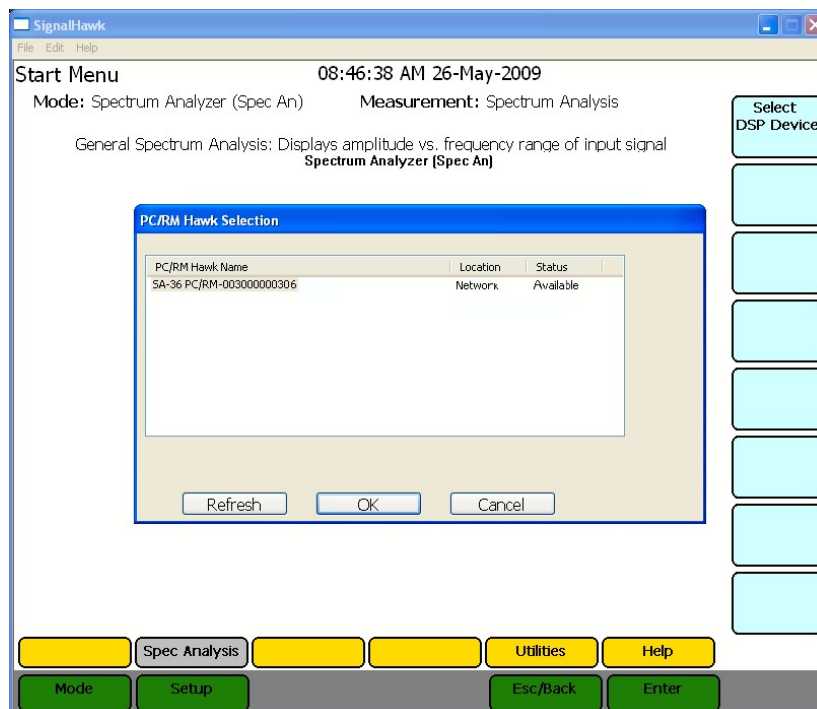

Connecting Remotely via LAN/WAN Connection

NOTE

The Rack Mount SignalHawk provides the following:

- 10/100 auto sensing RJ45 Ethernet connector
- Half and full duplex support
- IP address: 192.168.1.10
- Subnet Mask: 255.255.255.0

Configuring a Basic Network Connection

1. Make one of the following connections:
 - **For connecting to a stand alone computer** - Connect the Rack Mount SignalHawk to the computer with a crossover cable.
 - **For connecting to a network** - Connect the Rack Mount SignalHawk to the network using the cable supplied.

NOTE

Do not use the 'Pass-thru LAN' RJ-45 connector next to the BNC trigger connector for direct remote access. Use the RJ-45 connector in the PC back-panel.

2. Before making changes to the client computer, it is highly recommended to create a "System Restore Point":

NOTE

Permissions affiliated with being an administrator or a member of the Administrators group are needed in order to complete this procedure. If the computer is connected to a network, network policy settings might also prevent you from completing this procedure.

- a. Click Start.
- b. Right click Computer and select Properties.
- c. Click Advanced system settings (left pane).
- d. Select the System Protection Tab.
- e. Click the Create.... button.
- f. Type a description for the restore point and click Create.
- g. Wait for a message indicating the restore point was created.

3. Install TCP/IP Services on the client computer controlling the Rack Mount SignalHawk by doing the following:

NOTE

This is only required if the computer has not had TCP/IP services (networking) previously configured.

- a. Open Add or Remove Programs in Control Panel.
- b. Click Add/Remove Windows Components.
- c. In Components, select Networking Services, and then select Details.
- d. In Subcomponents of Networking Services, select Simple TCP/IP Services, and then click OK.
- e. Click Next.

NOTE

If prompted to do so, type the path where the Windows distribution files are located, and then click OK.

- f. Click Finish.
- g. Click Close.

4. Configure TCP/IP settings on the client computer:

NOTE

The client computer may have TCP/IP settings previously configured. Changing settings may prevent access to other network resources such as the Internet or file sharing. Consult with your network administrator before making any changes.

- a. Open Network and Sharing Center in Control Panel.
- b. Click Local Area Connection
- c. Click Properties
- d. Select Internet Protocol Version 4
- e. Click Properties
- f. On the General tab, click Use the following IP address:
- g. Type 192.168.1.11 into IP address:
- h. Type 255.255.255.0 into Subnet mask:

NOTE

- Default IP settings for the Rack Mount are IP address: 192.168.1.10 and Subnet Mask: 255.255.255.0. DHCP is NOT enabled by default on the Rack Mount SignalHawk.
- Use automated IP settings (DHCP) whenever possible for the majority of client computers. DHCP is enabled by default and when automated IP

settings are used for all connections, they eliminate the need to configure settings (i.e. DNS, WINS, etc.).

5. Create a Remote Desktop Connection on the client computer:
 - a. Open Remote Desktop Connection:
 - i. Click Start
 - ii. Select Programs or All Programs
 - iii. Select Accessories
 - iv. Click Remote Desktop Connection.
 - b. In the Computer box, type the following default IP address for the Rack Mount SignalHawk: 192.168.1.10
 - c. Click Connect.

NOTE

- If a connection cannot be achieved, disable the computers wireless networking function.
 - The client computer may have TCP/IP settings previously configured. Changing settings may prevent access to other network resources such as the Internet or file sharing. Consult with your network administrator before making any changes.
 - Depending on which version of Windows is being used, the Windows Security or the Log On to Windows dialog box appears at this time.
- d. In the Windows Security or Log On to Windows dialog box, type user credentials.

Example - User name, password, and domain. Default user credentials for the Rack Mount SignalHawk are:

Username: Bird

Password: Bird

- e. Click OK or Submit.

NOTE

To change the connection settings, (such as screen size, automatic logon information, and performance options), click Options before connecting. For more information, see "To Change Connection Settings" in the Remote Desktop Help.

Advanced network settings such as configuring the Rack Mount SignalHawk on a domain, can be configured by using the remote desktop connection or by logging in locally to the Rack Mount SignalHawk using an external monitor, keyboard and mouse (not included) connected to

the I/O ports on the back panel of the unit. Consult the network administrator for proper configuration.

NOTE

- Other programs may be used on the Rack Mount SignalHawk as long as they directly support its specific use or provide system utilities, resource management, anti-virus or similar protection. Software such as email, word processing, spreadsheet, database, scheduling or personal finance software cannot run on this device, however, you may use terminal services protocols to access such software running on a server. For more information, refer to the [Windows 7 Software License Terms](#).
- The Rack Mount SignalHawk operating system has Windows Firewall 'On' by default but does not have any anti-virus/anti-spyware installed. Use caution when connecting the Rack Mount SignalHawk to a WAN or Internet gateway. Consult with the network administrator.

Rack Mount SignalHawk Connection Diagram

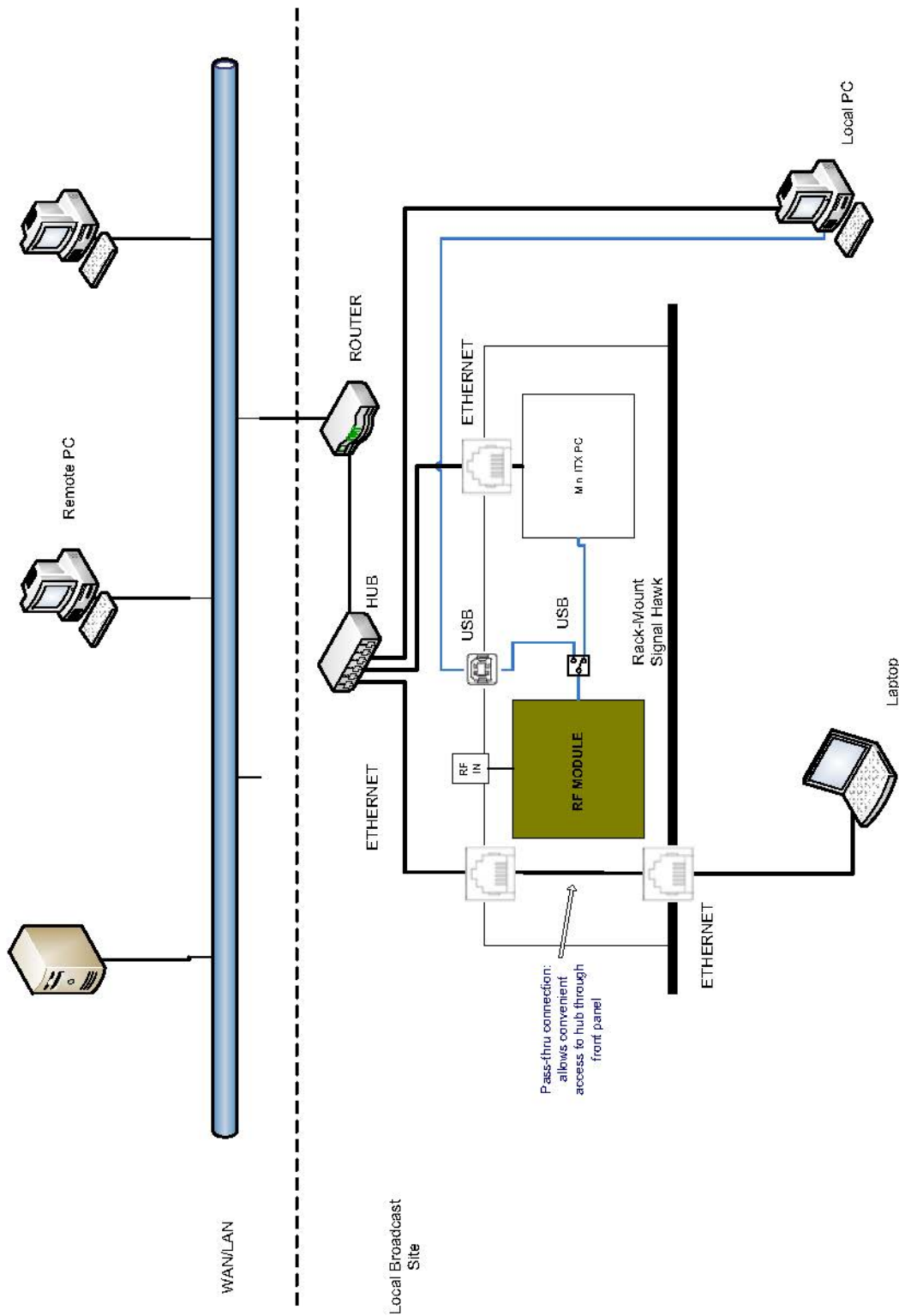

Connecting a Remote Computer to the Host Computer

To connect your home computer, which is the client (or remote) computer to the Rack Mount SignalHawk, follow these steps:

1. On your home computer, click Start, point to All , and then point to Accessories.
2. In the Accessories menu, point to Communications, and then click Remote Desktop Connection.
3. In the Computer box, type the computer name of the SignalHawk computer.

NOTE

The default computer name of the Rack Mount SignalHawk is 'SH36S-RM' and the default IP address and Subnet mask is 192.168.1.10 and 255.255.255.0

Remote Desktop Dialog Box



4. Click connect.

5. When the Log On to Windows dialog box appears, type your user name, password, and domain (if required), and then click OK.

Windows Security Dialog Box



6. The Remote Desktop window opens, and you see the desktop settings, files, and programs that are on the Rack Mount SignalHawk. Your Rack Mount SignalHawk remains locked, and nobody can access it without a password. In addition, no one will be able to see the work you are doing remotely.

To end your Remote Desktop session:

1. Click Start, and then click Log Off at the bottom of the Start menu.
2. If prompted, click Log Off.

User Interface Menus and Settings

In order to obtain the most accurate information possible, it is very important to use the proper settings. The SignalHawk can be configured in various ways, allowing for a wide range of measurement capabilities.

Getting Started with the SignalHawk

CAUTION

Spectrum Analyzer has a +20 dBm (100 mW) max. RF input. Exceeding the maximum input will damage the SignalHawk. If unsure of power levels, measure the test connection with a power sensor before using the SignalHawk.

Press the Power button to turn on the unit.

Setting Up

NOTE

For initial setup see [Rack-Mount SignalHawk Set-Up](#) or [PC SignalHawk Set-Up](#).

This chapter describes SignalHawk menus, software settings, measurements, and adjustments.

Start Menu

The Start menu displays a list of available measurements and access to setup options. Start Menu is access from any screen by pressing the on-screen Mode button.

SignalHawk Start Menu - Spectrum Analyzer

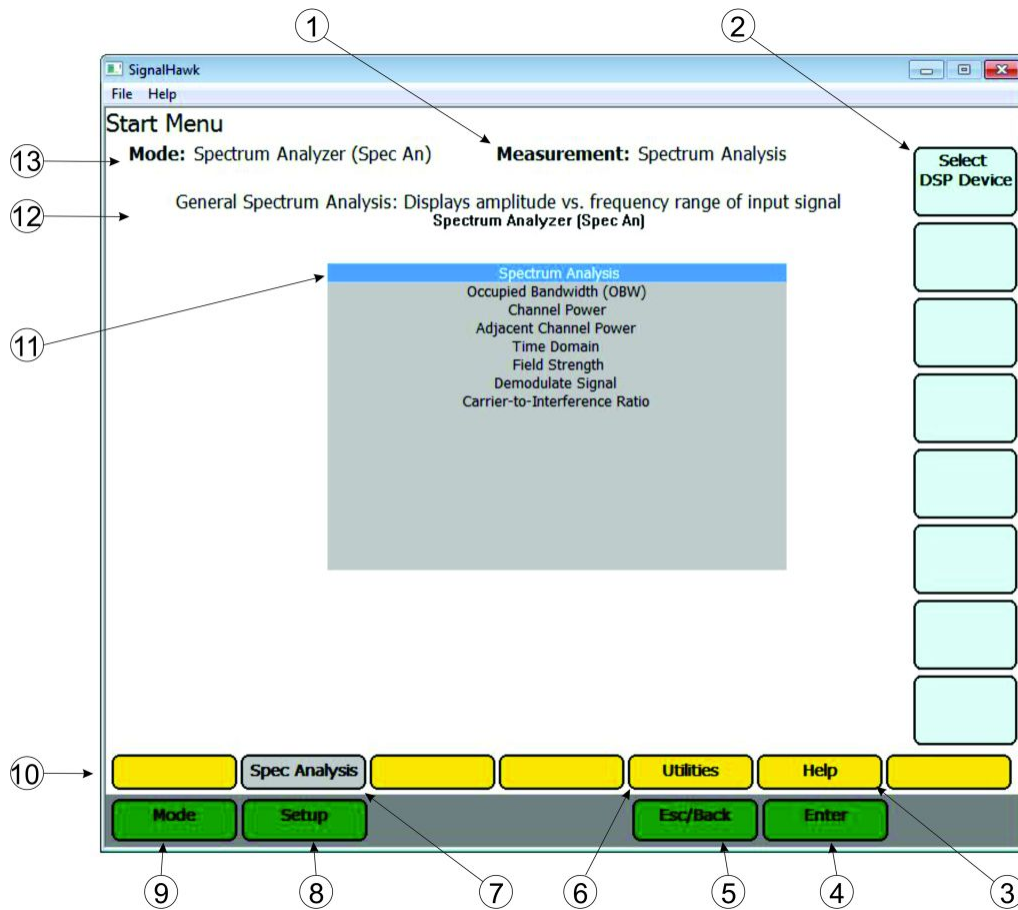

| Item | Name | Description |
|------|--------------|--|
| 1 | Measurement | Name of measurement selected on the measurement selection list (11). |
| 2 | Menu Options | The eight option keys display the options available in each menu. Mouse click to select or use keyboard function keys. Function Keys (F1 through F8) correlate with the menu options on the right side of the display. |
| 3 | Help | The Help menu displays options to view Spectrum Analyzer help and custom help. Help displays in an additional window and the start menu will remain open. Click on Back... to close the Help Menu. |

| | | |
|----|----------------------------|--|
| 4 | Esc/Back | Pressing Esc/Back will close options and return to the main menu screen. Esc key on the keyboard mimics this function. |
| 5 | Enter | Pressing Enter will activate the Measurement Option Selection on the Measurement selection list (11) and open Spectrum Analyzer screen. Enter key on the keyboard mimics this function. |
| 6 | Utilities | Click here to display the Utility Menu main screen. The Utilities menu provides access to the Version Info Menu, the GPS Info Menu, displays the system date and time, and provides contact information for Bird Technologies Group.. The Version Info Menu provides information about the instrument software, amount of available memory, battery charge status. The GPS Info Menu provides Lat, long and Altitude, as well as GPS satellite reception. Pressing Esc/Back will exit the Utilities menu and return to the Start Menu. See the Utilities menu . |
| 7 | Spec Analysis | Pressing Spec Analysis will highlight Spectrum Analysis on the Measurement Selection List (11). Enter must be pressed to activate the measurement and open Spectrum Analyzer screen. |
| 8 | Setup | Pressing Setup will display the Setup Menu. The Setup Menu displays options to save the current setup and allows access to saved setups and settings used previously on the SignalHawk, for a detailed explanation see setup menu . |
| 9 | Mode | Pressing Mode will display the Start Menu Measurement Selection screen. |
| 10 | Menu selection | The menu selection keys display the menu options available for the current mode or Menu. On the Start Menu the Menu Selection keys allow access to the Utilities and Help Menus. In the Spec Analysis Mode the menu selection keys allow access to the Freq & Span , BW & Sweep , Ampt & Trace , Measure , Mark & Limit , File & Help , Adv. Logging menus. |
| 11 | Measurement Selection List | Displays the list of all measurements available in the active operating mode. When a measurement is highlighted a description of the measurement is displayed (12). Pressing enter will activate the selected measurement and open Spectrum Analyzer screen. |
| 12 | Measurement Description | Name and brief description of highlighted measurement |
| 13 | Operating Mode | Displays the current active operating mode |
| -- | | Mouse scroll wheel will increase or decrease selected values. |
| -- | | Keyboard can be used to manually enter values. |

Setup Menu

The Setup Menu allows access to saved setups and settings used previously on the SignalHawk. Click on Setup to access the menu.

Setup Menu

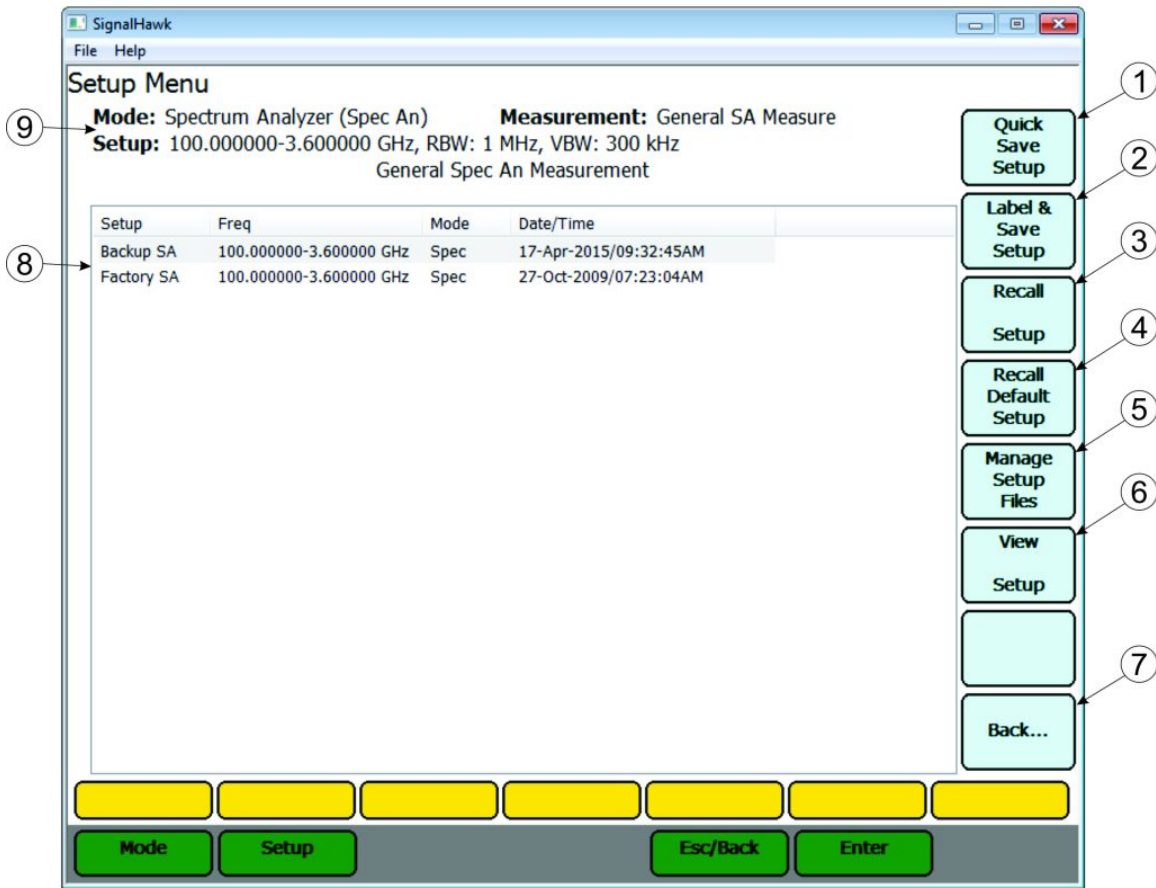

| Item | Name | Description |
|------|------------------|--|
| 1 | Quick Save Setup | When pressed automatically names and saves the current Spectrum Analyzer settings. The saved settings are stored as a file in the internal drive of the SignalHawk. Each quick save is stored in a separate file that is named using the date-time file naming format GeneralSA(DD-MM-YYYY-hh-mm-ss).shs where DD is the day, MM is the month, YYYY is the year, hh is the hour, mm is the minute, and ss is the second of the time when the file was saved. |

| | | |
|---|------------------------|---|
| 2 | Label and Save Setup | When pressed opens a save dialog for saving the current Spectrum Analyzer settings. See Label and save Setup Menu for a detailed explanation. |
| 3 | Recall Setup | Recalls the saved setup highlighted in the Saved Setup File List (8) and sets the instrument parameters to run the recalled setup. |
| 4 | Recall Default Setup | Recalls the factory default setup and sets the instrument parameters to run this setup. |
| 5 | Manage Setup Files | Displays options for viewing details of each saved setup file and deleting one or all saved setup files. See Manage Setup Files for a detailed explanation. |
| 6 | View Setup | Displays the properties of the saved setup highlighted in the Saved Setup File List (8) and displays additional options. See View Setup Menu . |
| 7 | Back... | Pressing Back... will close the Setup Screen and open the previously displayed screen (measurement Spec A screen or the Start Menu). |
| 8 | Saved Setup File List | Displays all of the currently saved setup files. |
| 9 | Setup File description | Displays basic description of the highlighted file in the Saved Setup File List (8). |

Label & Save Setup Menu

The Label and Save Setup menu and dialog box provide the ability to give unique names, titles, subtitles and add notes when saving a setup file.

Label & Save Setup Menu

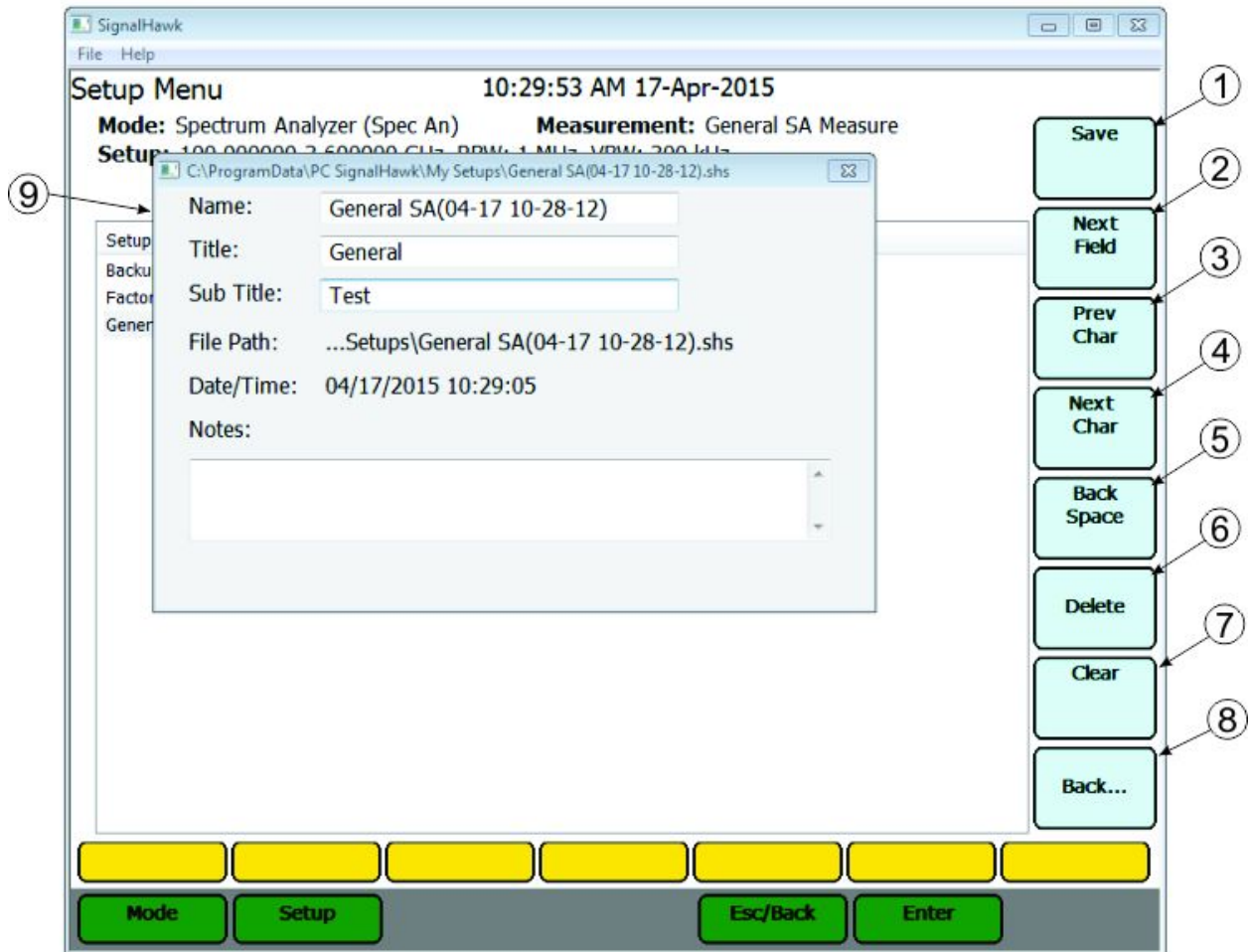

| Item | Name | Description |
|------|------------|---|
| 1 | Save | When pressed saves the Setup and closes the Label and Save Dialog Box (9). If no changes were made to the file name in the dialog box a prompt will be displayed verifying intent to overwrite the existing file. Titles, subtitles, and notes can be added to existing saved setups. |
| 2 | Next Field | When pressed advances the cursor to the next text entry field. |
| 3 | Prev Char | When pressed moves the cursor one character to the left in the active text entry field. |

| | | |
|---|---------------------------|--|
| 4 | Next Char | When pressed moves the cursor one character to the right in the active text entry field. |
| 5 | Back Space | When pressed deletes the character to the left of the cursor in the active text entry field. |
| 6 | Delete | When pressed deletes the character to the right of the cursor in the active text entry field. |
| 7 | Clear | When pressed clears all text in the active text entry field. |
| 8 | Back... | Pressing Back... will cancel the save operation and close the Label and Save Dialog Box. |
| 9 | Label and Save Dialog Box | Provides the ability to give unique names, titles, subtitles and add notes when saving a setup file. |

Manage Setup Files Menu

Manage Setup Files

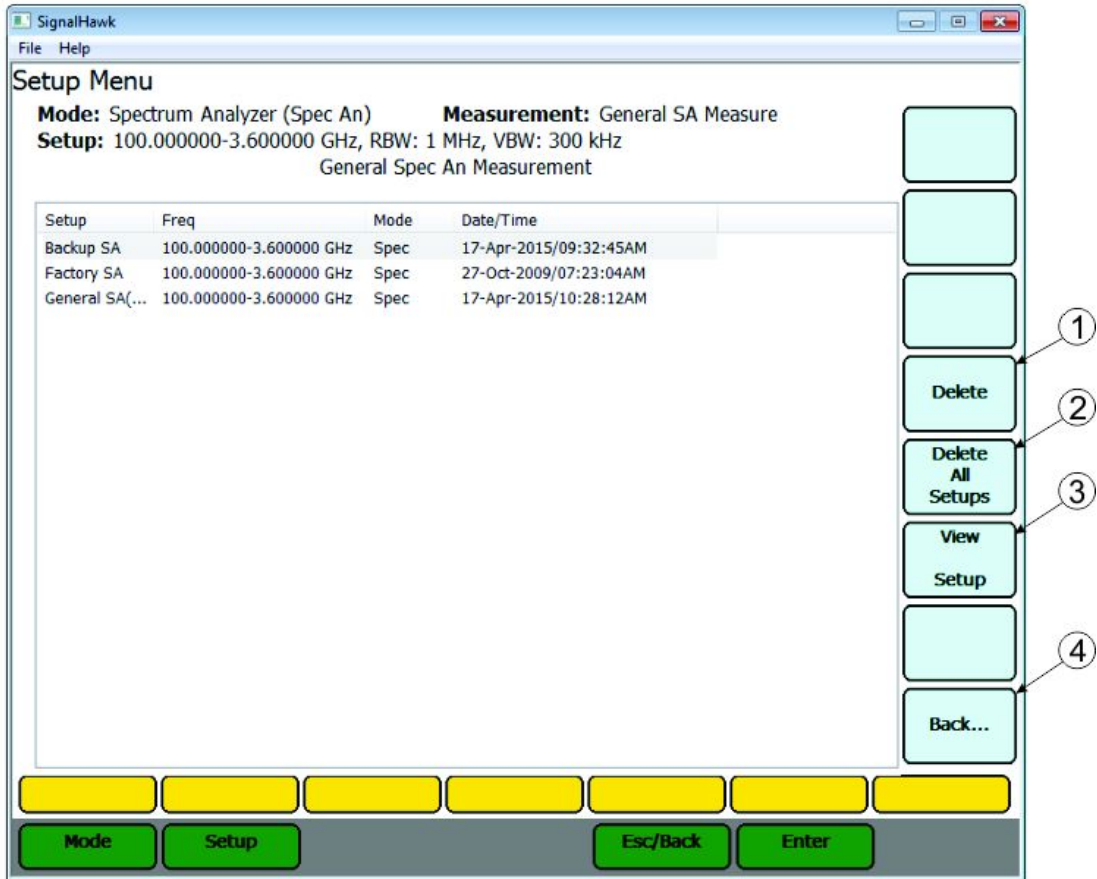

| Item | Name | Description |
|------|-------------------|--|
| 1 | Delete | When pressed deletes the saved setup file highlighted in the Saved Setup File List. |
| 2 | Delete All Setups | When pressed deletes all of the saved setup files on the list. NOTE The Factory Setup cannot be deleted. |
| 3 | View Setup | Displays the properties of the saved setup highlighted in the Saved Setup File List and displays additional options. See View Setup Menu . |
| 4 | Back... | When pressed exits the Manage Setup Files Menu and returns to the main Setup Menu. |

View Setup Menu

Displays the properties of a selected saved Setup file.

View Setup Menu

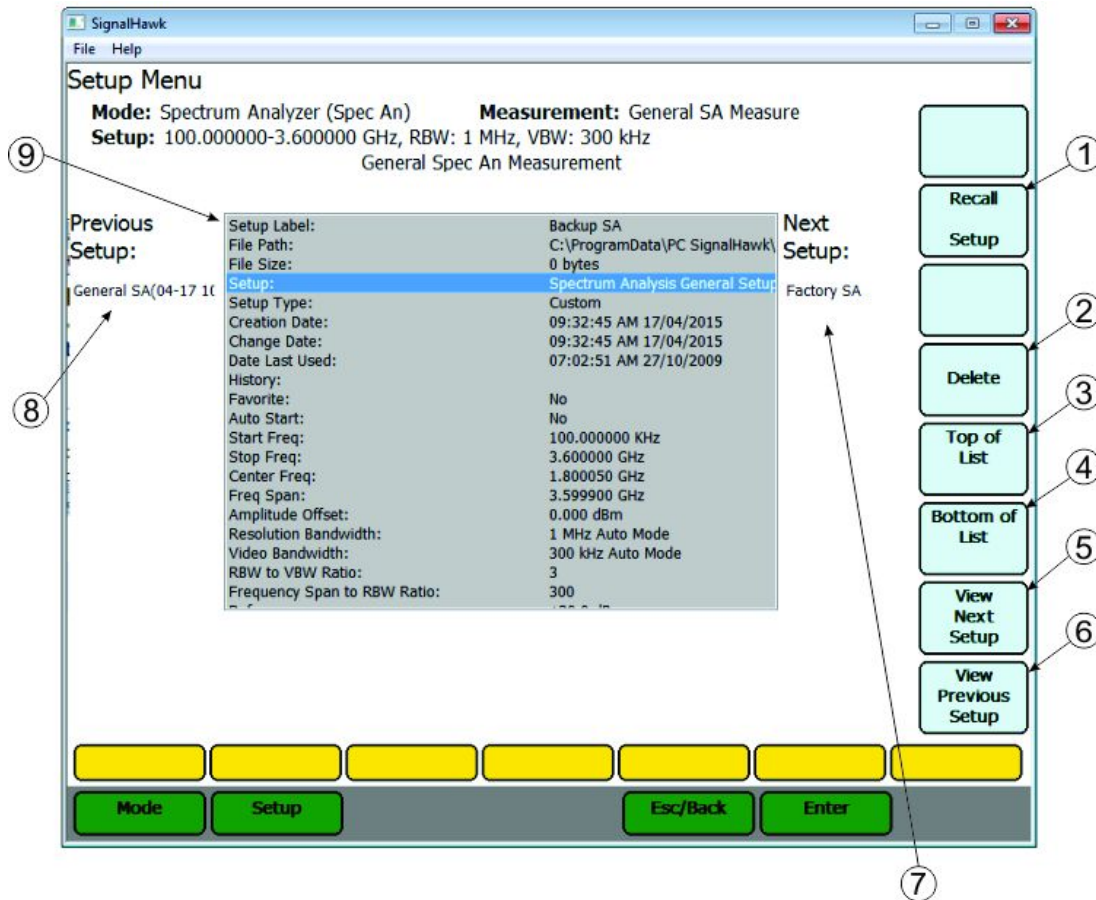

| Item | Name | Description |
|------|---------------------|--|
| 1 | Recall Setup | Recalls the displayed saved setup (9) and sets the instruments parameters to run the recalled setup. |
| 2 | Delete | When pressed deletes the displayed saved setup (9). |
| 3 | Top of List | when pressed highlights the top line of the displayed saved setup (9). |
| 4 | Bottom of List | when pressed highlights the bottom line of the displayed saved setup (9). |
| 5 | View Next Setup | When pressed displays the next saved setup (7) on the list of saved setups. |
| 6 | View Previous Setup | When pressed displays the previous saved setup (8) on the list of saved setups. |
| 7 | Next Setup | Shows the name of the next saved setup. |

| | | |
|---|--------------------------------------|---|
| 8 | Previous Setup | Shows the name of the previous saved setup. |
| 9 | Saved Setup Parameter Settings | List of all the settings in the currently displayed saved setup file. |

SignalHawk Spectrum Analyzer Screen Overview

General Screen Features

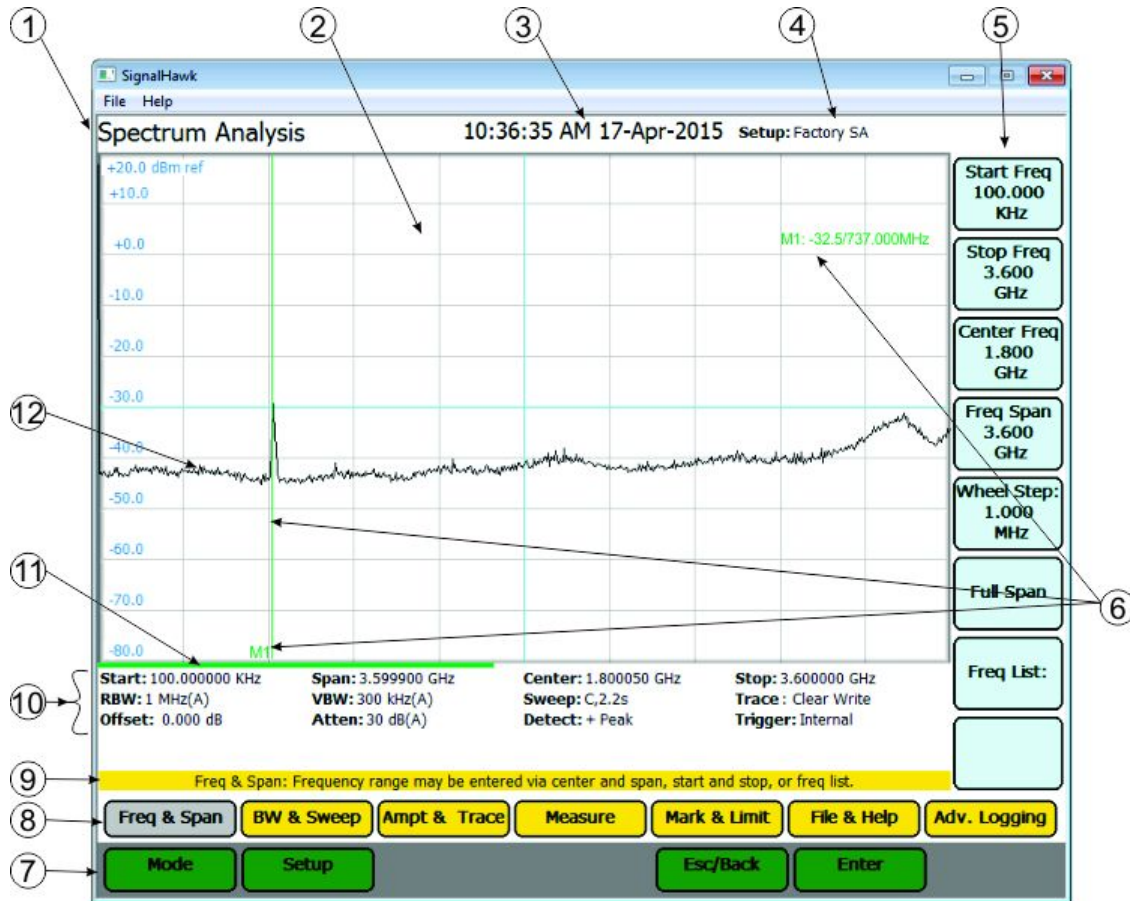

| Item | Name | Description |
|------|--------------------|--|
| 1 | Measurement | Displays the name of measurement selected on Startup Menu or saved setup file. |
| 2 | Sweep display area | Traces are displayed in the Sweep Display area. |
| 3 | Date and time | Displays the current Date and time. |
| 4 | Setup File Name | Display the name of the last saved setup selected. |
| 5 | Menu option keys | The eight option keys display the options available in the active menu (8). Mouse click to select or use keyboard function keys. Function Keys (F1 through F8) correlate with the menu options on the right side of the display. |

| | | |
|----|----------------------|---|
| 6 | Marker | Markers are displayed as a vertical line or as a flag. Each marker is tagged with a number and the markers associated frequency and power level data are displayed in the top right quadrant of the sweep display area. |
| 7 | System menu keys | Provide access to system menus (Startup and Setup) and entry and escape/back keys. |
| 8 | Menu selection keys | <p>The menu selection keys display the menu options available for the current Menu. In the Spec Analysis Mode the menu selection keys allow access to the Freq & Span, BW & Sweep, Ampt & Trace, Measure, Mark & Limit, File & Help, Adv. Logging menus.</p> <p>Grey color indicates the active menu, yellow indicates inactive menus. The options for the active menu are displayed on the Menu Option Keys (5).</p> |
| 9 | Active Menu Hints | Displays helpful hints for the active menu. |
| 10 | Measurement settings | Displays the settings for the mode/measurement. |
| 11 | Sweep progress bar | Indicates the progress of the current sweep. |
| 12 | Data trace | Graphical display of the current signal measurement and settings. |

Freq & Span Menu

In the Freq & Span Menu the range of frequencies to sweep are specified. The SignalHawk can sweep frequencies between 100 kHz and 3.6 GHz.

Frequencies can be selected at spans from 1 kHz up to the entire range of the instrument. These frequencies can be set to sweep by one of the following methods:

- Set the Center Freq and Freq Span.
- Set the Start Freq and Stop Freq.
- Select the Full Span of the instrument.
- Select a band from the Freq List.

The most common of these methods is to set the center frequency and a frequency span (a range) and let SignalHawk calculate the start and stop frequencies for the sweep. Reducing the span, by default (with RBW and VBW, both on auto mode) will usually speed up the sweep, provide more detail, and lower the noise floor. Unless specified otherwise, set the center frequency to the center of the signal being measured.

NOTE

Grey color indicates the menu option is active, option will remain active until Esc is pressed or mouse is click outside the option key.

Freq & Span Menu



| Item | Name | Description |
|------|-------------|---|
| 1 | Start Freq | Frequency value on the frequency option keys indicate the frequency setting for the sweep. |
| 2 | Stop Freq | <p>Clicking an option key makes that option active. when an option is active any of the following will change the frequency value:</p> <ul style="list-style-type: none"> Up/Down Arrow Keys: Increase and decrease the frequency or span in small steps. Left/Right Arrow Keys: Increase and decrease the frequency or span in large steps. Mouse Scroll Wheel: Each click of the mouse scroll wheel changes the frequency or span by the value of the "Wheel Step". Number Keys: Pressing any number key will open a dialog box and change the option keys to unit selection. Enter the desired numerical value, press Esc/Back or clear at anytime to delete and error. When done, press |
| 3 | Center Freq | |

| | | |
|---|------------|--|
| 4 | Freq Span | <p>enter (to keep the same frequency units) or click the option key corresponding to the desired units.</p> <p>NOTE Grey color indicates the menu option is active, option will remain active until Esc is pressed or mouse is click outside the option key.</p> |
| 5 | Wheel Step | <p>Value displayed on the Wheel Step key Indicates the value added to or subtracted from any of the frequency keys(1 -4) when active by moving the mouse wheel.</p> <p>Click the Wheel Stop Key to change the wheel value. When the option is active any of the following will change the step value:</p> <ul style="list-style-type: none"> • Up/Down Arrow Keys and Mouse Scroll Wheel: Change the step value by a small amount. • Left/Right Arrow Keys:Change the step value by a large amount. • umber Keys: Press any key except +/- to open a box to type in a new <p>frequency. If a mistake is made, press Esc/Back. When done, press enter, or click the menu selection corresponding to the desired units.</p> |
| 6 | Full Span | <p>When pressed changes the sweep to the full frequency span 0.0 Hz to 3.6 GHz</p> <p>NOTE The start frequency can be set to 0 as a convenience. However, the accuracy spec does not apply below the minimum freq of the unit (100 kHz).</p> |
| 7 | Freq List: | <p>When pressed displays a list of predefined frequency bands. Use the up/down arrows or mouse scroll wheel to scroll to the desired band, then press Enter to use the selected values. Recently used bands are displayed at the top of the list.</p> <p>NOTE Channelized bands are denoted on the Frequency List by a plus sign; “+”.</p> |
| 8 | Channel | <p>Displays the selected channel when a channelized band is selected from the Freq List (7). When clicked, allows selection of channel within the selected channelized band.</p> <p>NOTE This option only available if a channelized band is selected in the Freq List option (7)</p> |

BW & Sweep Menu

The bandwidth menu includes functions that control sweep speed and accuracy, and has the interface for customizing sweep triggers.

When two signals are separated by a freq distance equal to the Resolution BW, a 3 dB dip between them will appear on the screen. This is the minimum resolvable frequency spacing. The menu selections legend displays the current value.

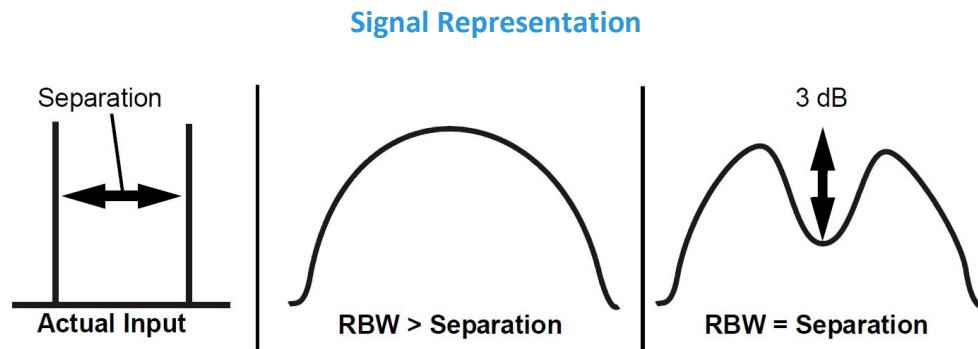

Lowering the RBW will lower the noise floor, which can make low-power signals easier to see, and makes readings close to the noise floor more accurate.

BW & Sweep Menu



| Item | Name | Description |
|------|------------------------------|---|
| 1 | Resolution BW Mode Auto/Man. | <p>When clicked, toggles Resolution BW Mode between auto and manual control.</p> <p>Auto - RBW is set based upon the frequency span. When in Auto mode, the RBW is set according to the nearest ratio of the Span/RBW (5) selection. The default ratio is 300. When the frequency span is reduced, the RBW will also be reduced accordingly.</p> <p>Example - When the span is changed to 3600 MHz, the RBW will automatically be set to 1 MHz. When the span is reduced to 100 MHz, the RBW will automatically reduce to 300 kHz.</p> <p>Manual - RBW is controlled by changing the setting in Resolution BW (2).</p> |

| | | |
|---|-------------------------|--|
| 2 | Resolution BW | <p>Indicates the current setting for Resolution BW. If manually changed Resolution BW Mode (1) is automatically set to manual.</p> <p>To change click on Resolution BW then use the mouse wheel, keyboard arrow keys, or number pad to change the RBW. RBW range is 100 Hz - 1 MHz, in steps of 1 / 3 / 10 (e.g.: 1 kHz to 3 kHz to 10 kHz to 30 kHz, etc.). Right and Left keyboard arrow key will set BW to minimum or maximum value.</p> |
| 3 | Video BW Mode Auto/Man. | <p>When clicked, toggles Video BW Mode between auto and manual control.</p> <p>Auto - VBW is set based upon the RBW value. When in Auto mode, the VBW is set according to the nearest ratio as set using the VBW/RBW (6) selection. The default ratio is 3. As the RBW span is reduced the VBW will be reduced accordingly.</p> <p>Example - When the RBW is changed to 1MHz, the VBW will automatically be set to 300kHz. When the RBW is reduced to 30kHz, the VBW will automatically be set to 10kHz.</p> <p>Manual - VBW is controlled by changing the setting in Video BW (4).</p> |
| 4 | Video BW | <p>Indicates the current setting for Video BW (how much smoothing is applied to the signal). If manually changed Video BW Mode (3) is automatically set to manual.</p> <p>To change click on Video BW then use the mouse wheel, keyboard arrow keys, or number pad to change the VBW. VBW range is 10 Hz - 300 kHz. Right and Left keyboard arrow key will set BW to minimum or maximum value.</p> <p>Wide (high) VBW setting: Faster sweep times, but can obscure signal details.</p> <p>Narrow (lower) VBW setting: Better trace smoothing for signals present in high noise levels.</p> <p>As the VBW is reduced, longer sweep times will be necessary to obtain a measurement. To be useful, VBW must be narrower than RBW. No smoothing takes place when VBW is greater than or equal to RBW.</p> |

| | | |
|---|----------------|--|
| 5 | Span/RBW | <p>The ratio of frequency span to RBW determines how the RBW tracks with frequency span when the Resolution BW mode is in Auto. The default ratio is 300. Range is 10 to 3600 in steps of one.</p> <p>This value is ignored when Resolution BW Mode(1) is in Manual mode.</p> <p>Mouse Scroll Wheel and Up and Down Arrow Keys will increase or decrease the ratio in steps of one. The Left and Right Arrow Keys will set the ratio to minimum (left-arrow) or maximum (right-arrow).</p> |
| 6 | RBW/VBW | <p>This is the ratio used to set VBW, when VBW is set to auto. RBW is divided by the RBW/VBW value to set the VBW.</p> <p>To change, click the RBW/VBW option key and a list of allowed values for RBW/VBW will be displayed. Scroll to the desired value and hit enter, or double click to select a new ratio.</p> |
| 7 | Detection Mode | <p>Detection mode allows the user to choose how the collected data in each pixel is represented. See Detection Mode Menu for a detailed explanation.</p> |
| 8 | Sweep | <p>Sweep sets up the properties of individual sweeps that the SignalHawk performs. See Sweep Menu for a detailed explanation.</p> |

Detection Mode Menu

Depending on measurement settings, many more data points are collected than there are pixels on the screen. Detection modes allow the user to choose how the collected data in each pixel is represented.

Detection Mode Menu

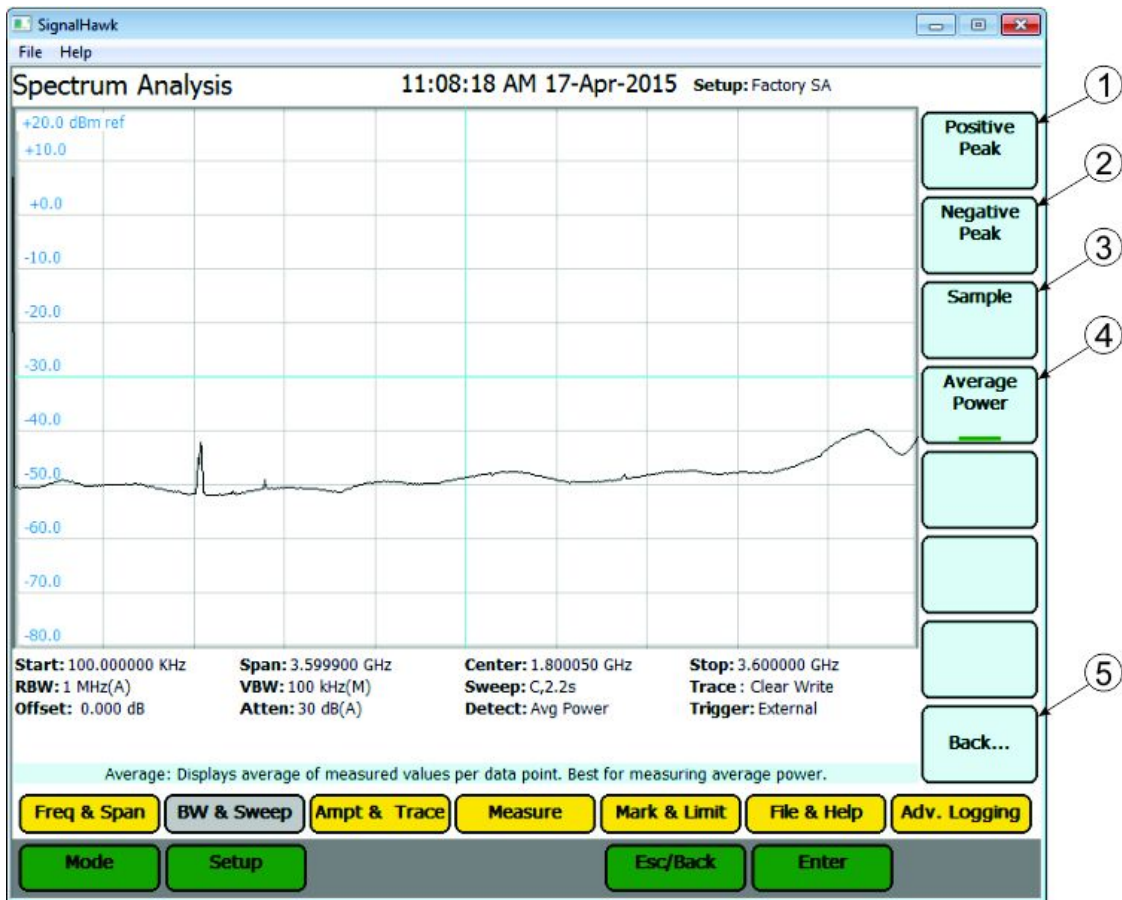

| Item | Name | Description |
|------|---------------|--|
| 1 | Positive Peak | + Peak Detection - Returns the maximum value of the data collected for each display pixel. Recommended for pure sine waves or narrow bandwidth signals. In zero-span mode, this mode acts like a peak detector and can be used to show AM band frequencies. |
| 2 | Negative Peak | - Peak Detection - Returns the minimum value of the data collected for each display pixel. Recommended for displaying the difference between CW and pulsed signals. |
| 3 | Sample | Sample Detection - Returns a sample of the data collected for each display pixel. Use this method for noise-like signals. |

| | | |
|---|---------------|---|
| 4 | Average Power | Average Power - Returns the average of the data collected for each display pixel. Recommended for noise-reduction. |
| 5 | Back... | When clicked, closes the Detection Mode Menu and returns to the BW & Sweep Menu. |

Sweep Menu

Sweep sets up the properties of individual sweeps that the SignalHawk performs. It can set whether the sweeping is continuous or single, and the properties of video triggers (if enabled).

Sweep Menu

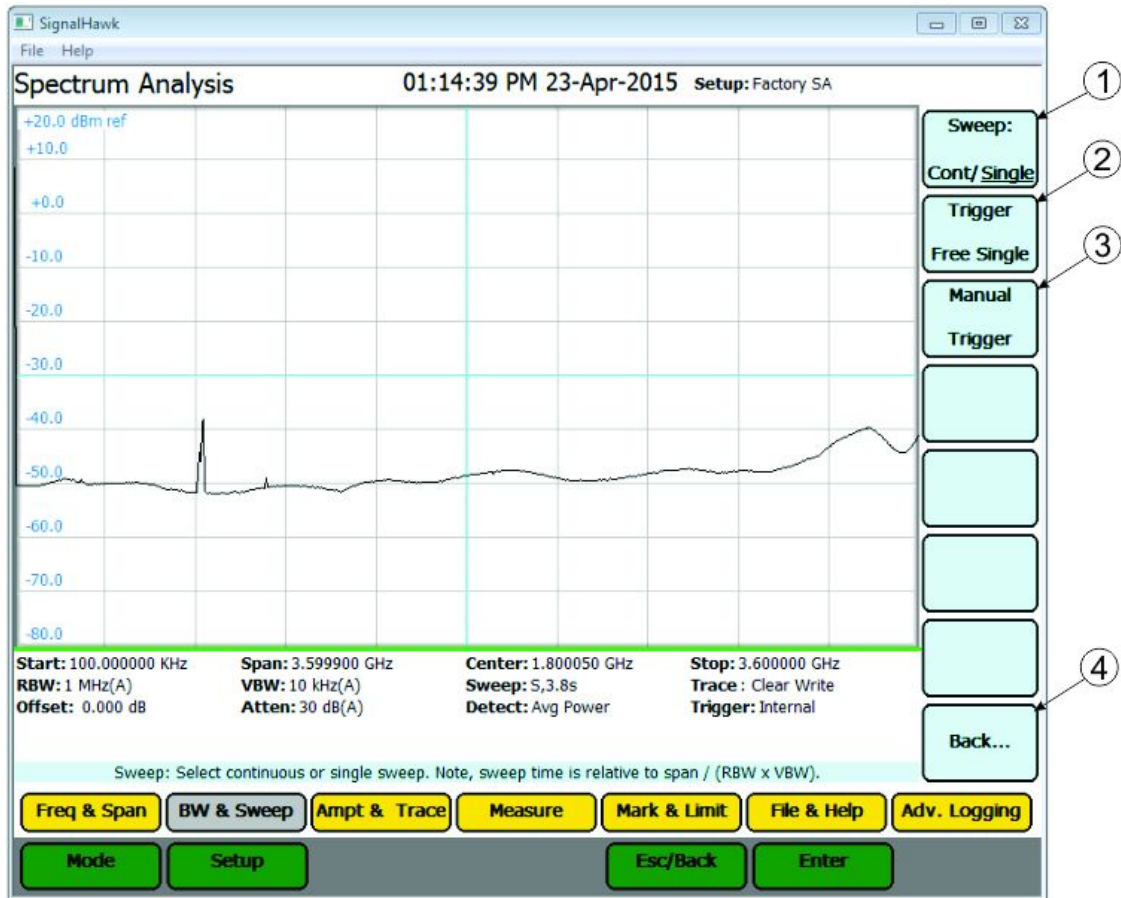

| Item | Name | Description |
|------|-------|---|
| 1 | Sweep | <p>When clicked, toggles between continuous or single sweep operation.</p> <p>Single - SignalHawk will perform one sweep and stop, the sweep will be displayed until another sweep is triggered.</p> <p>Continuous - Signal Hawk will perform one sweep, then immediately begin the next sweep, overwriting the previous sweep.</p> |

| | | |
|---|-------------------------------------|---|
| 2 | Trigger | Option used to select trigger source, options are internal (single/continuous) or external (single/continuous). See Trigger Source Menu for detailed explanation. |
| 3 | Manual Trigger or Arm Trigger | <p>Manual trigger option is only available (visible) when Sweep option is set to internal single.</p> <p>Arm Trigger option is only available (visible) when External Single is selected as the trigger source (2).</p> |
| 4 | Back... | When clicked, closes the Sweep Menu and returns to the BW & Sweep Menu. |

Trigger Source Menu

Trigger Source Menu

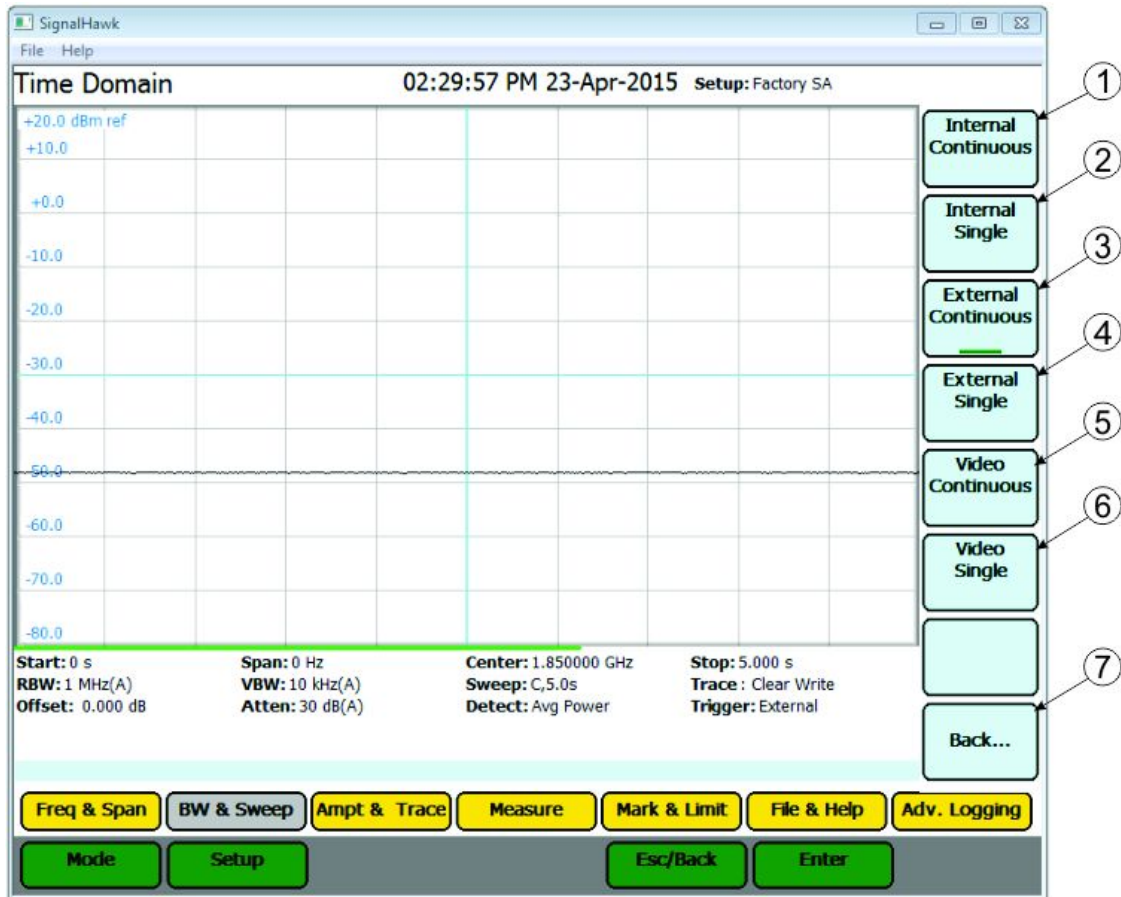

| Item | Name | Description |
|------|---------------------|--|
| 1 | Internal Continuous | Sweeps continuously and is controlled by the SignalHawk. |
| 2 | Internal Single | Sweeps once when triggered. Controlled by the Signal-Hawk through the Manual Trigger soft key on the Sweep Menu . |
| 3 | External Continuous | Sweeps continuously and is controlled by an external trigger. See External Trigger Menu for a detailed explanation. |
| 4 | External Single | Sweeps once when triggered. Controlled by an external trigger. May also be triggered using the Arm Trigger soft key on the Sweep Menu . NOTE Useful for signals that are time varying. Ones that change slow enough to trigger manually as well as carrier/interference ratios. See Carrier-to-Interference Ratio . |

| | | |
|---|------------------|---|
| 5 | Video Continuous | Sweeps continuously once triggered. Controlled by the signal video settings on the Video Trigger Menu . |
| 6 | Video Single | Sweeps once when triggered. Controlled by the signal video settings on the Video Trigger Menu . |
| 7 | Back... | When clicked, closes the Trigger Source Menu and returns to the Sweep Menu. |

External Trigger Menu

External Trigger Menu

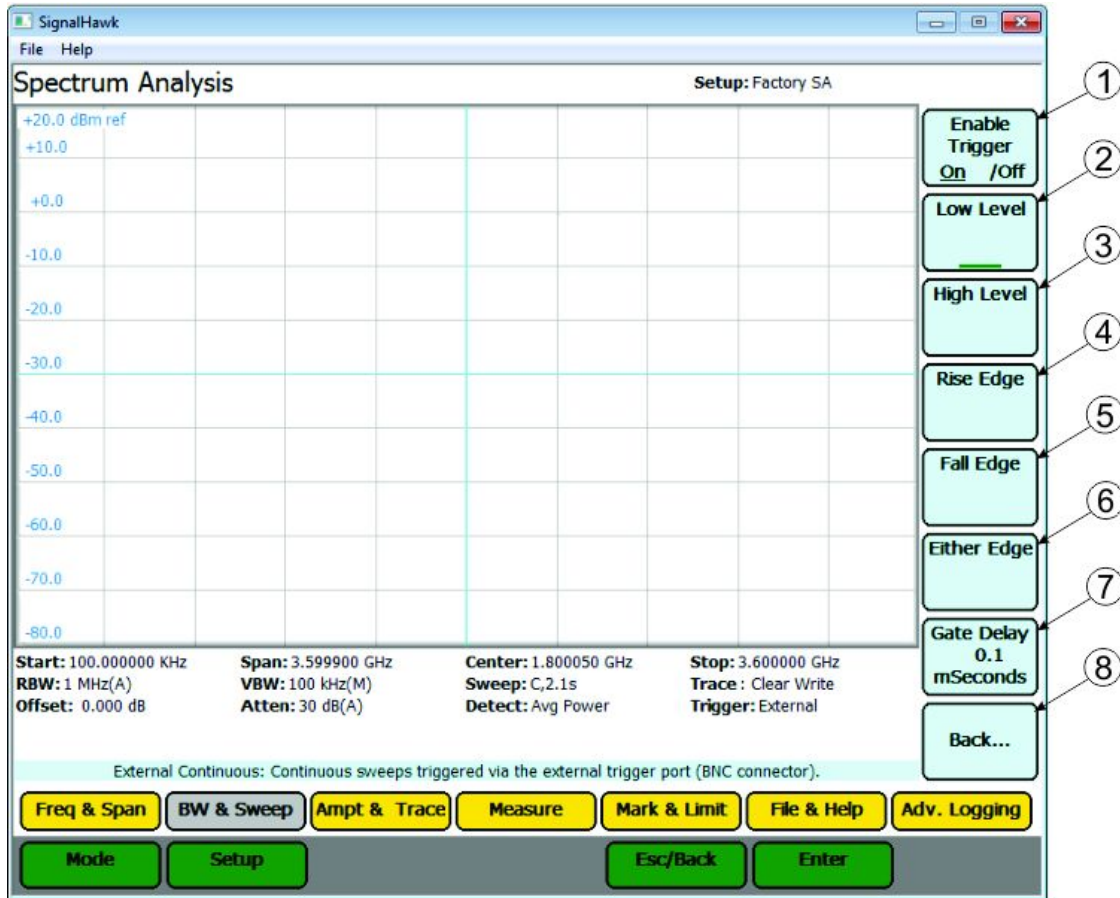

| Item | Name | Description |
|------|------------------------|--|
| 1 | Enable Trigger On /Off | Indicates trigger source, Set to On for external trigger, Off for internal trigger. |
| 2 | Low Level | Triggers a sweep if input = 0 ± 0.5 V (TTL "Low"). |
| 3 | High Level | Triggers a sweep if input = 4.2 ± 0.8 V (TTL "High") |
| 4 | Rise Edge | Triggers a sweep if the input goes from "Low" to "High". |
| 5 | Fall Edge | Triggers a sweep if the input goes from "High" to "Low". |
| 6 | Either Edge | Triggers a sweep if the input goes from either "High" to "Low" OR "Low" to "High". |
| 7 | Gate Delay | Length of wait after the trigger signal and before beginning a sweep. The range is 100 μ s to 1 s. |
| 8 | Back... | When clicked, closes the External Trigger Menu and returns to the Trigger Source Menu. |

Video Trigger Menu

NOTE

This can only be used if the Time Domain measurement is enabled. See [Time Domain \(Zero Span\) Measurement](#).

Trigger control and sweeping both happen on the radio frequency connector. Once a sweep is done, it will be displayed until a trigger condition occurs again and it performs another sweep. This is used in zero-span mode.

Video Trigger Menu

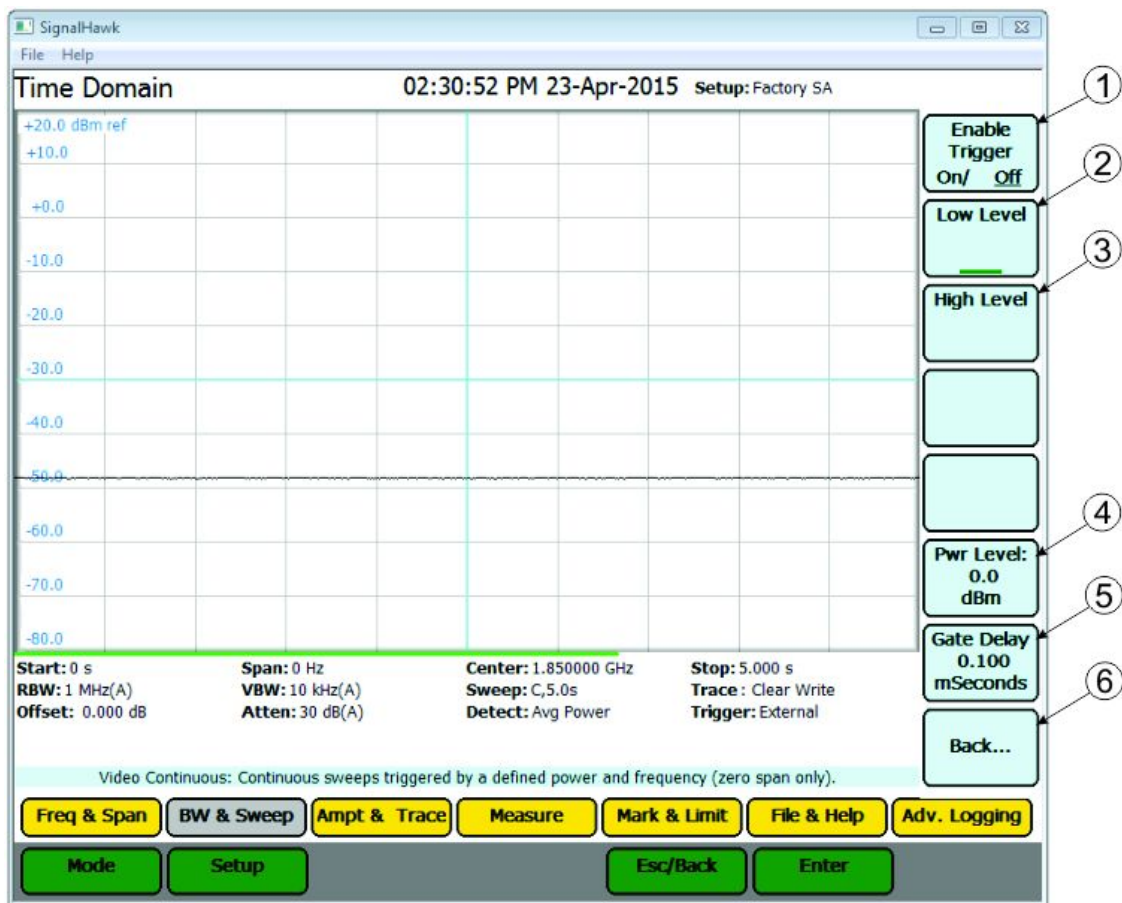

| Item | Name | Description |
|------|---------------------------|--|
| 1 | Enable Trigger On /Off | Indicates trigger source, Set to On for video trigger, Off for continuous trigger. |
| 2 | Low Level | Triggers a sweep if dBm falls BELOW the power level. |
| 3 | High Level | Triggers a sweep if dBm rises ABOVE the power level. |

| | | |
|---|-------------|---|
| 4 | Power Level | Sets the power level used to triggers a sweep, if the power level meets the “Low” or “High” criteria. Set the power level using the keypad. |
| 5 | Gate Delay | Length of wait after the trigger signal and before beginning a sweep. The range is 100 μ s to 1 s. |
| 6 | Back... | When clicked, closes the Video Trigger Menu and returns to the Trigger Source Menu. |

Ampt & Trace Menu

Ampt & Trace Menu

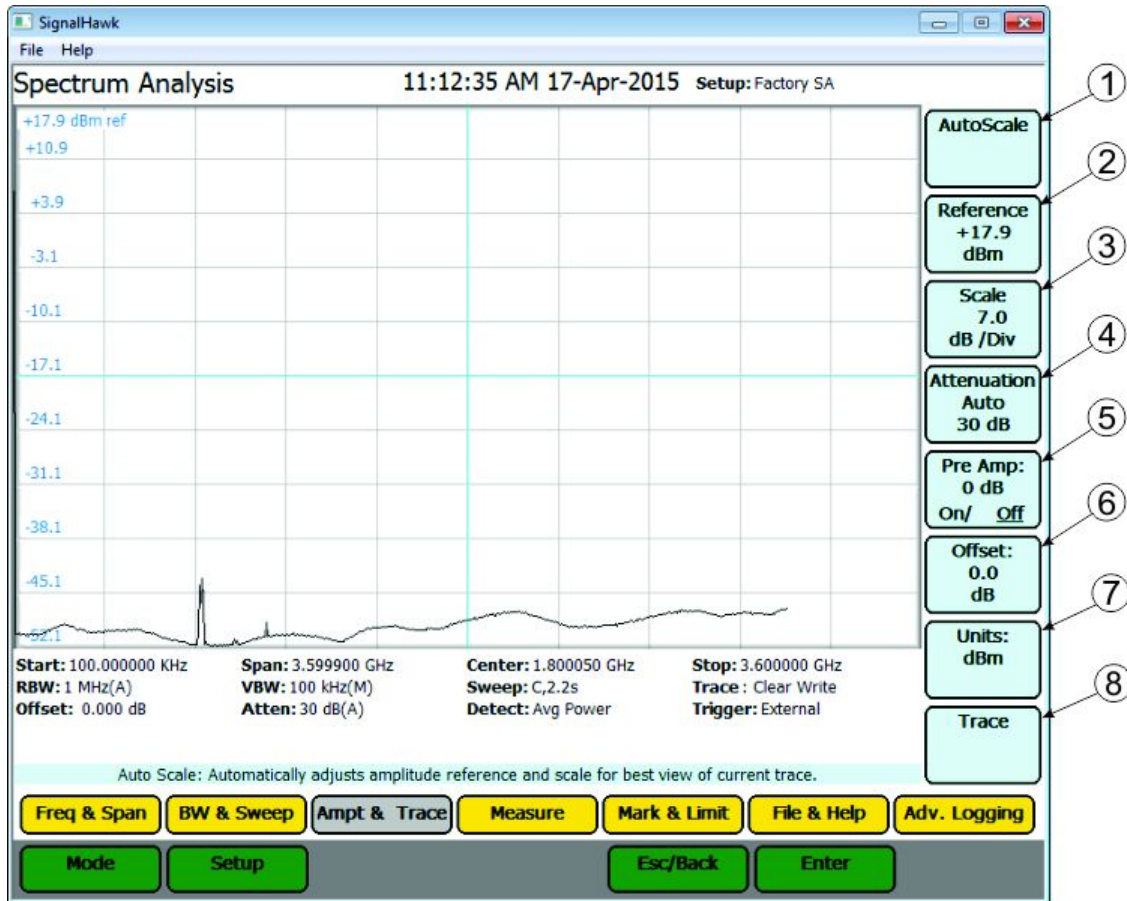

| Item | Name | Description |
|------|-----------|--|
| 1 | AutoScale | Resizes the graph to fit the whole trace on the screen. This function will change the reference and scale of a trace. |
| 2 | Reference | Sets the y-axis value at the top of the graph. |
| 3 | Scale | Sets the dB value of each partition of the graph on a scale from 1 to 15. The graph is partitioned into 10 divisions, giving a set number of dB per division. NOTE This soft key is not displayed if the Units of measure is in Volt or Watt. |

| | | |
|---|-------------|---|
| 4 | Attenuation | <p>Controls the built-in attenuator on the signal input. This reduces the amplitude of a high-powered signal. The attenuation can be set to Auto, or at levels of 0, 10, 20, and 30 dB. The reported value of the signal is automatically corrected for the selected attenuation.</p> <p>NOTE When the Reference is set to a higher setting, Attenuation will automatically set itself above this setting.</p> <p>Example - Reference is set to 25 dBm, Attenuation automatically sets itself to 30 dB and cannot be lowered.</p> |
| 5 | Pre Amp | <p>Controls the built-in amplifier on the signal input. This lowers the noise floor, allowing very low power signals be detected, by giving a 24 dB nominal gain boost.</p> <p>NOTE</p> <ul style="list-style-type: none"> • Attenuation is automatically disabled to 0 when Preamp is activated. • The preamp should not be used with input signals greater than -30 dBm. |
| 6 | Offset | <p>Shifts the signal to compensate for external factors (attenuation, couplers, amplifiers, etc.) This allows for a true signal level reading.</p> <ol style="list-style-type: none"> 1. Measure the total amount of loss for all attached signal devices. 2. Enter the measured amount as the Offset value or gain. <p>Example - The system has 10 dB of loss due the use of a coupler; enter the value of 10 in the Offset. Offset range is -100 to +100.</p> |

| | | |
|---|-------|---|
| 7 | Units | <p>dBm $\text{dBm} = 10 \times \text{Log}[\text{Power}(\text{Watts})] + 30 \text{ dB}$</p> <p>dBuV $\text{dBm} = \text{dBuV} - 10 \times (\text{log}50) - 90$</p> <p>dBmV $\text{dBm} = \text{dBmV} - 10 \times (\text{log}50 - 30)$</p> <p>dBV $\text{dBm} = \text{dBV} - 10 \times (\text{log}50 + 30)$</p> <p>Volts $\text{dBm} = 20 \times \text{Log}[\text{Power}(\text{Volts})] + 30 \text{ dB}$</p> <p>Watts $\text{Watts} = 10^{\Lambda((\text{dBm} - 30)/10)}$</p> |
| 8 | Trace | <p>Opens the trace submenu. See Trace Submenu for a detailed description.</p> |

Trace Submenu

Trace Submenu

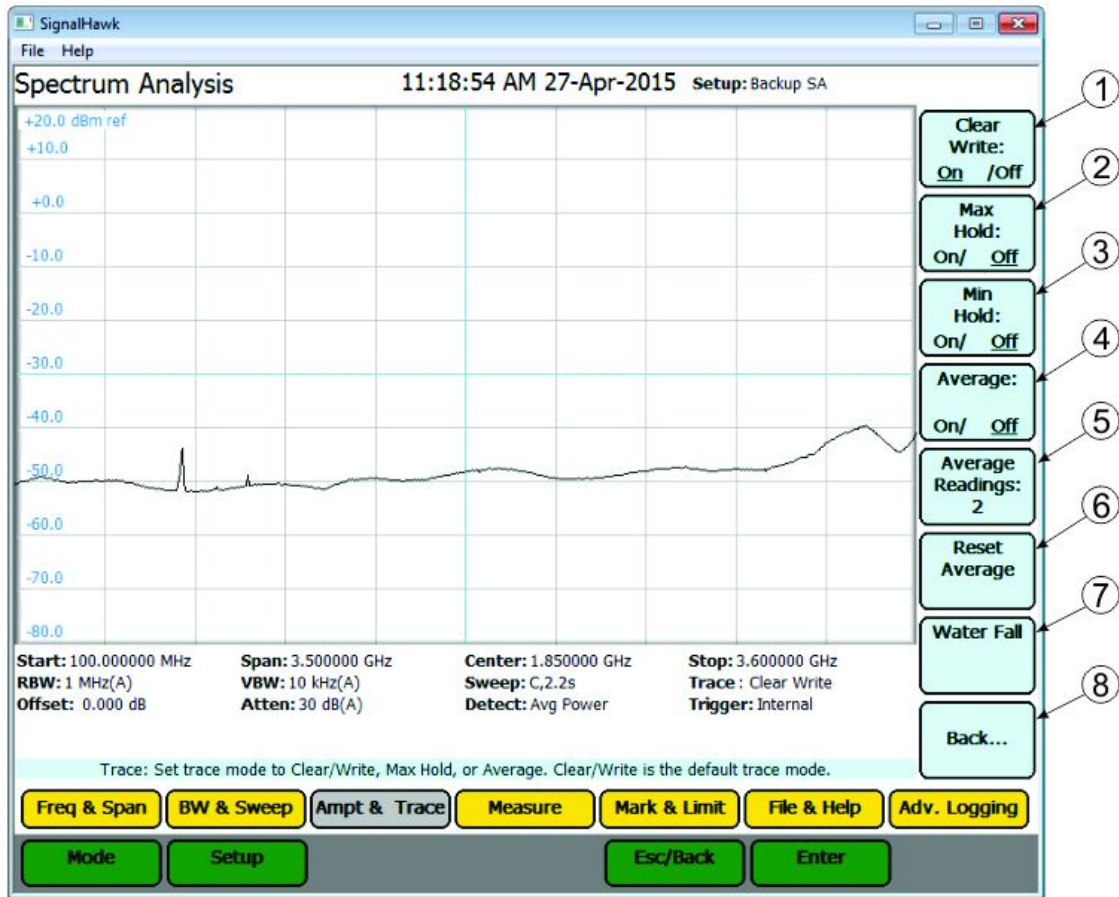

| Item | Name | Description |
|------|------------------|---|
| 1 | Clear Write | Switches off the Average and Max Hold functions. |
| 2 | Max Hold | Holds and displays the highest point of a any given sweep until Max Hold is turned off. |
| 3 | Min Hold | Holds and displays the lowest point of any given sweep until Min Hold is turned off. |
| 4 | Average | Displays the running average of multiple readings which is used to smooth a signal and decrease noise amplitude. |
| 5 | Average Readings | Sets the number of averaged readings. The valid range is from 2 to 1024. |
| 6 | Reset Average | Resets the current running average of multiple readings. |
| 7 | Waterfall | The Water Fall Spectrogram shows how the spectral density of a signal varies with time and presents it in a visual image. See Water Fall Menu for a detailed explanation. |

| | | |
|---|---------|--|
| 8 | Back... | When clicked, closes the Trace Submenu and returns to the Ampt & Trace Menu. |
|---|---------|--|

Water Fall Spectrogram Menu

The Water Fall Spectrogram shows how the spectral density of a signal varies with time and presents it in a visual image. Also known as spectral waterfalls, sonograms, voiceprints, or voicegrams, spectrograms are used to identify phonetic sounds and specific noise disturbances.

1. Go to the Ampt & Trace menu.
2. Click on the Trace selection.
3. Click on the Water Fall selection.
4. Turn the Water Fall spectrogram on.
5. Select the dual screen display, if desired

Water Fall Spectrogram

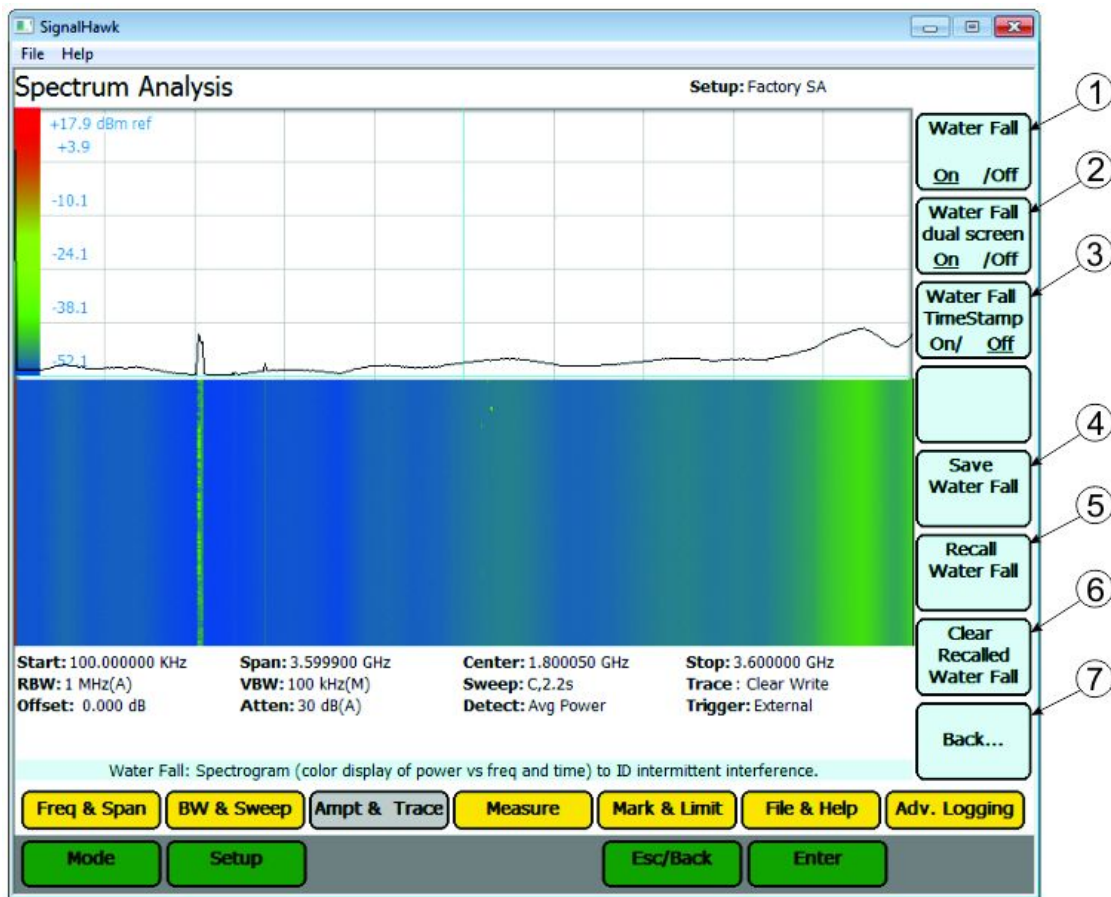

| Item | Name | Description |
|------|------------------------|--|
| 1 | Water Fall | Switches Water Fall display on and off. |
| 2 | Water Fall Dual Screen | On: Displays the sweep and waterfall displays in a split screen. Off: Displays the Water Fall Spectrogram only. |

| | | |
|---|---------------------------|--|
| 3 | Water Fall Timestamp | When set to On, Time stamps are displayed on the left side of the Water Fall Spectrograph to indicate elapsed time at periodic intervals. |
| 4 | Save Water Fall | Saves the current Water Fall display using the Date and Time for file names. |
| 5 | Recall Water Fall | When clicked displays a list of all Saved Water Fall Spectrographs. Selecting a Water Fall spectrograph from the list will cause the Spectrograph to be displayed on the screen. |
| 6 | Clear Recalled Water Fall | Clears spectrograph from the screen. |
| 7 | Back... | When clicked, closes the Water Fall Menu and returns to the Trace Submenu. |

Measure Menu

The Measure Menu provides access to measurements to help further analyze signal data. See [Measurements](#) section for procedures and additional information for each measurement.

Measure Menu

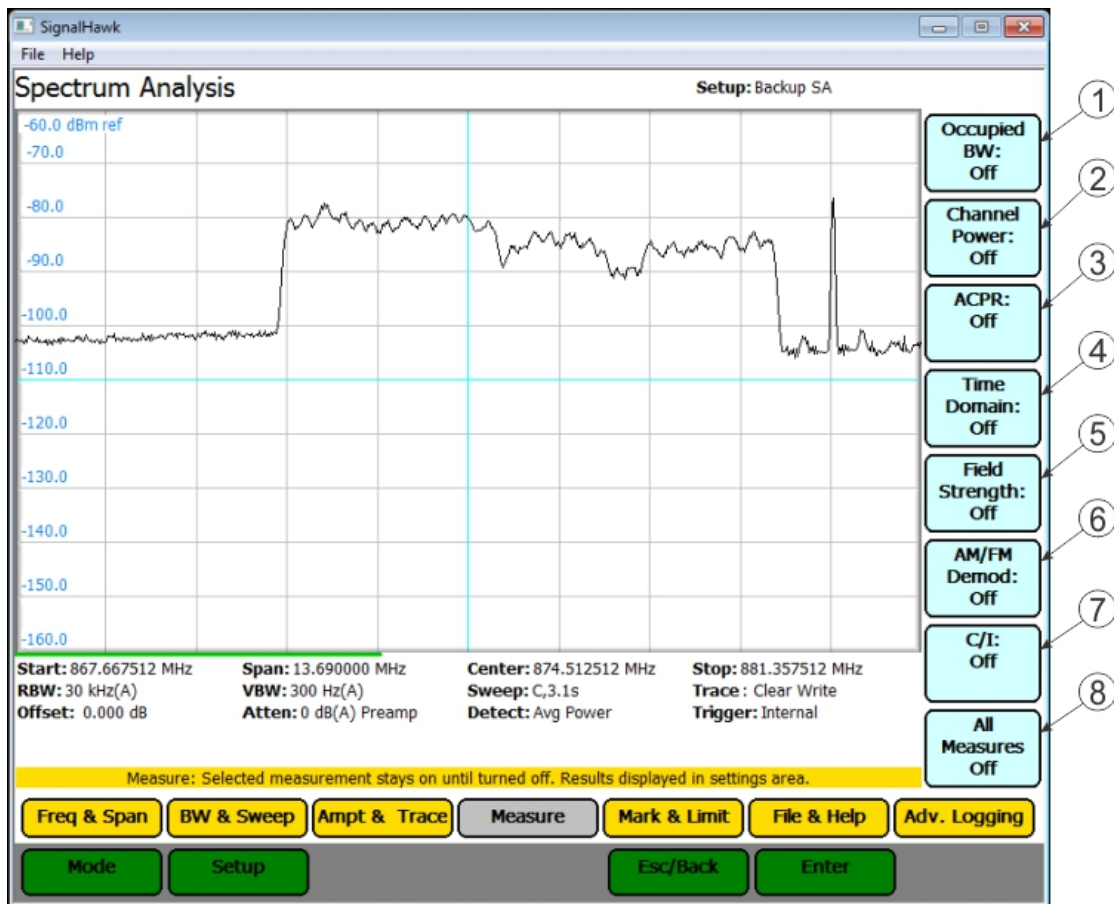

| Item | Name | Description |
|------|--------------------|--|
| 1 | Occupied Bandwidth | Occupied Bandwidth measures the frequency band bandwidth that contains a specified percentage of the total power of the signal. See Occupied Bandwidth Measurement for additional details and measurement procedure. |
| 2 | Channel Power | Channel Power measures the Integration Bandwidth, the total power over a frequency range, concentrated on the center frequency of the sweep. See Channel Power Measurement for additional details and measurement procedure. |

| | | |
|---|------------------|--|
| 3 | ACPR | Adjacent Channel Power measures the relative power of frequency bands adjacent to a central channel. See Adjacent Channel Power Measurement for additional details and measurement procedure. |
| 4 | Time Domain | Time Domain measures the amplitude of a single frequency, rather than sweeping a range of frequencies. See Time Domain (Zero Span) Measurement for additional details and measurement procedure. |
| 5 | Field Strength | Field Strength measures the signals received by an antenna. See Field Strength Measurement for additional details and measurement procedure. |
| 6 | AM/FM Demod | Removes the carrier from a signal and sends the demodulated signal to the internal speaker or headphones. See Demodulate Signal Measurement for additional details and measurement procedure. |
| 7 | C/I | Calculates the ratio of the carrier signal power to the power level of the noise and interference signals. See Carrier-to-Interference Ratio Measurement for additional details and measurement procedure. |
| 8 | All Measures Off | When clicked, turns off any automated measurement function that is on. |

Mark & Limit Menu

Mark & Limit Menu

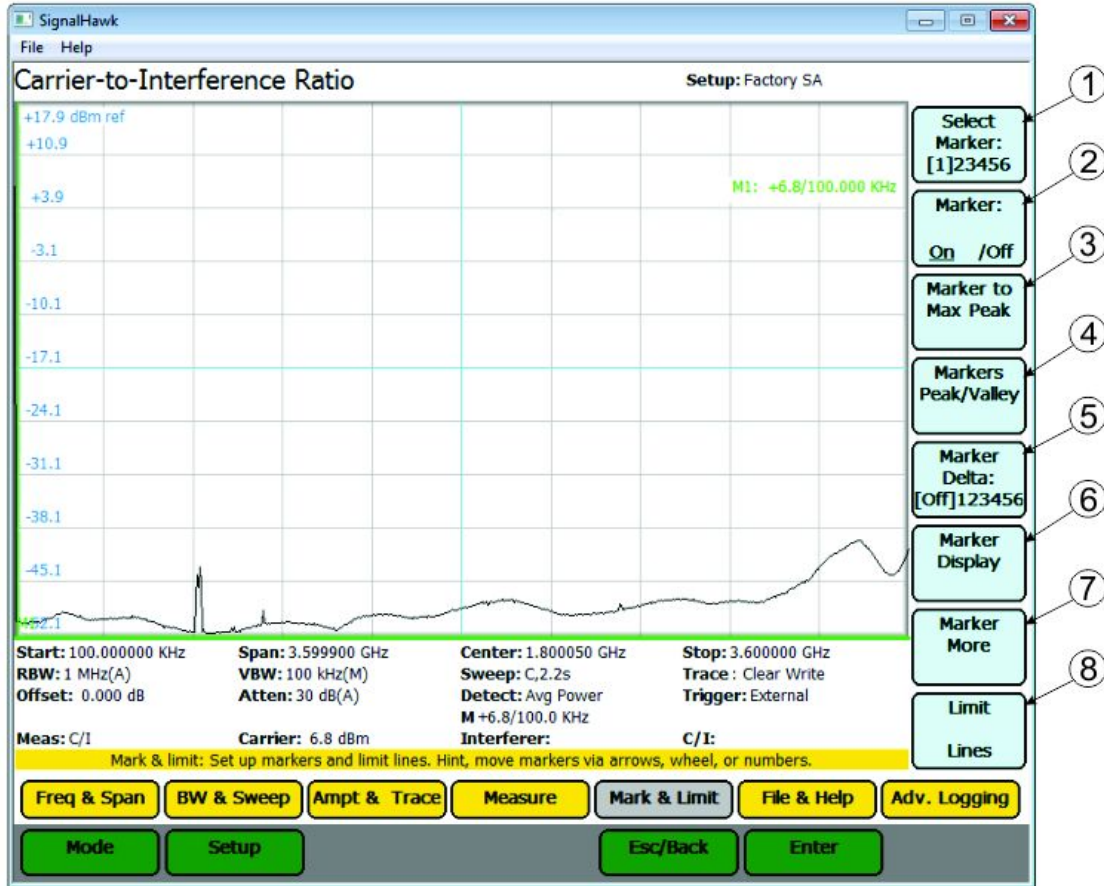

| Item | Name | Description |
|------|---------------------|---|
| 1 | Select Marker | Changes the active marker. There are six markers to choose from (measurements that use some of the markers for data display have fewer selectable markers). Pressing the soft key will cycle through each of the six markers. |
| 2 | Marker On/Off | Displays or hides the selected marker (1). |
| 3 | Marker to Max Peak | Moves the selected marker (1) to the highest point on the trace. |
| 4 | Markers Peak/Valley | When Clicked displays the Marker Peak/Valley Menu. See Marker Peak Valley Menu . |
| 5 | Marker Delta | Turns On/Off and displays the delta of the one to five markers. |
| 6 | Marker Display | When Clicked displays the Marker Display Menu. See Marker Display Menu . |
| 7 | Marker More | When Clicked displays the Marker Display Menu. See Marker More Menu . |

| | | |
|---|-------------|--|
| 8 | Limit Lines | When clicked displays the Limit Lines Menu. See Limit Lines Menu . |
|---|-------------|--|

Marker Peak/Valley Menu

Marker Peak/Valley Menu

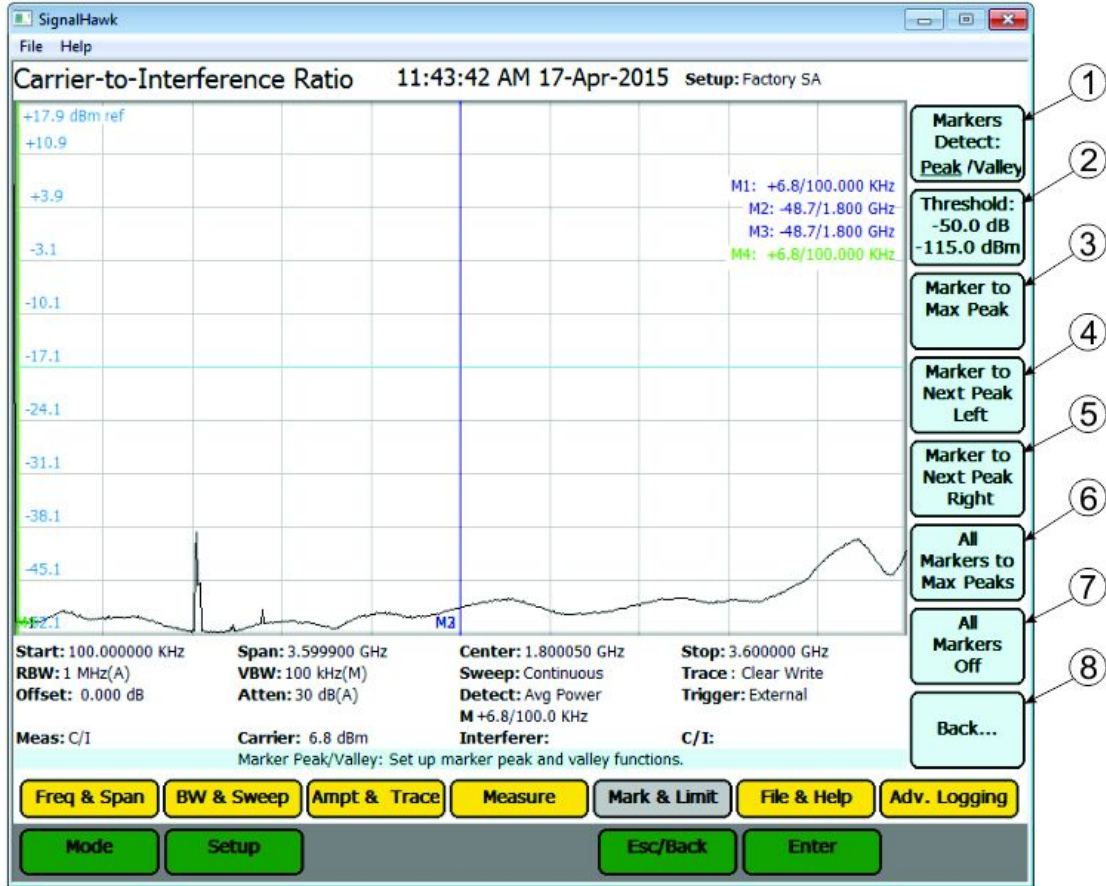

| Item | Name | Description |
|------|----------------|--|
| 1 | Markers Detect | Toggles the functionality of the submenu between finding peaks or finding valleys. |
| 2 | Threshold | <p>The threshold offset, displayed on the first line, is used to calculate the threshold level, displayed on the second line, above the noise floor.</p> <p>NOTE The low level peaks below the threshold level are filtered out. Only peaks above or at the threshold level are detected.</p> |

| | | |
|---|---|--|
| 3 | <p>Marker to Max Peak</p> <p>Marker to Min Valley</p> | <p>Which option is available is controlled by Markers Detect (1).</p> <p>When Marker Detect set to Peak, this option moves the selected marker to the highest point on the trace.</p> <p>When Marker Detect set to Valley, this option moves the selected marker to the lowest point on the trace.</p> |
| 4 | <p>Marker to Next Peak Left</p> <p>Marker to Next Valley Left</p> | <p>Which option is available is controlled by Markers Detect (1).</p> <p>When Marker Detect set to Peak, this option moves the selected marker to the highest point to the left of the current marker position.</p> <p>When Marker Detect set to Valley, this option moves the selected marker to the lowest point to the left of the current marker position.</p> |
| 5 | <p>Marker to Next Peak Right</p> <p>Marker to Next Valley Right</p> | <p>Which option is available is controlled by Markers Detect (1).</p> <p>When Marker Detect set to Peak, this option moves the selected marker to the highest point to the right of the current marker position.</p> <p>When Marker Detect set to Valley, this option moves the selected marker to the lowest point to the right of the current marker position.</p> |
| 6 | <p>All Markers to Max Peaks</p> <p>All Makers to Min Valleys</p> | <p>Which option is available is controlled by Markers Detect (1).</p> <p>Sets all the markers to either the maximum peaks or minimum valleys depending on the selection in Markers Detect (1).</p> |
| 7 | All Markers Off | Turns off all markers on the trace. |
| 8 | Back... | When Clicked closes the Marker Peak/Valley Menu and returns to the Mark & Limit Menu. |

Marker Display Menu

Marker Display Menu

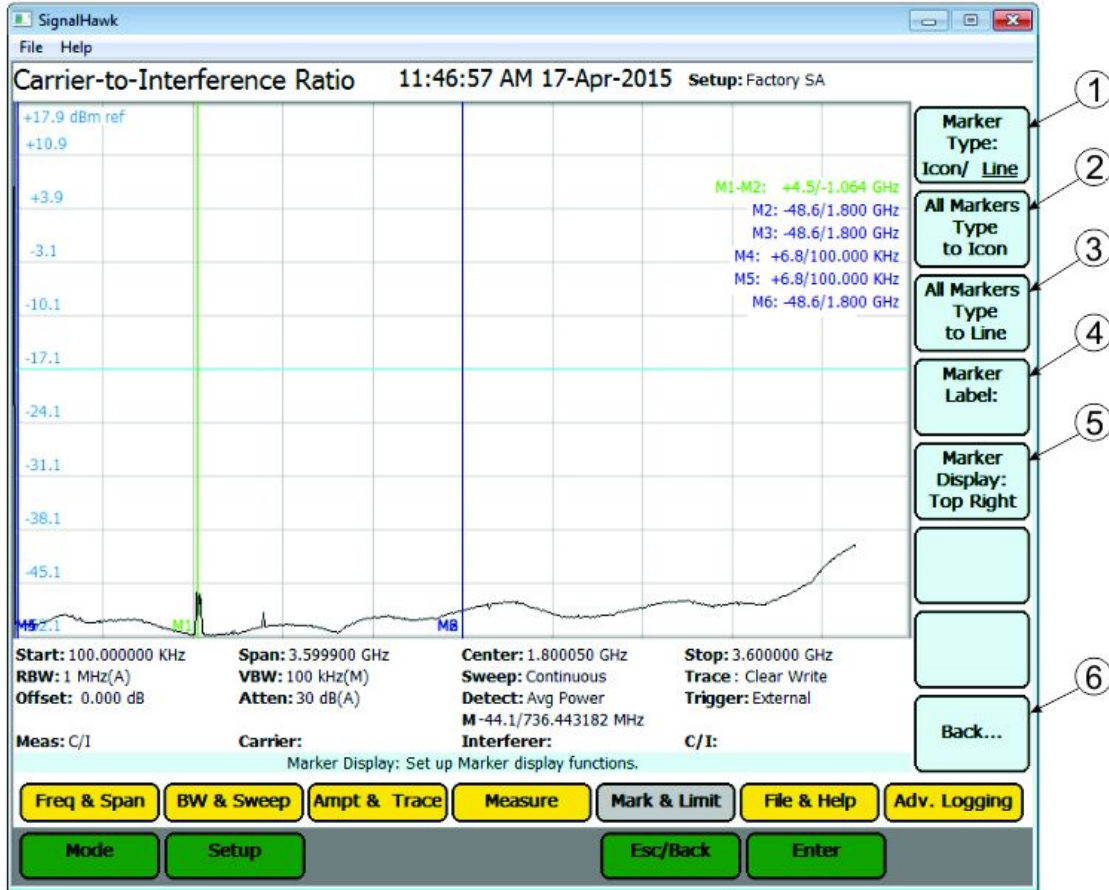

| Item | Name | Description |
|------|---------------------------|--|
| 1 | Marker Type | Sets the current marker to either be displayed as a line or floating numbered icon. |
| 2 | All Markers Type to Icon | Sets all markers to be displayed as floating numbered icons. |
| 3 | All Markers Type to Lines | Sets all markers to be displayed as numbered lines. |
| 4 | Marker Label | When Clicked opens a text box allowing the user to name the marker, the label is applied to the marker that was selected on the Mark & Limit Menu. |
| 5 | Marker Display | Turns On/Off the marker list, and sets the location of the marker list on the display. The marker list can be displayed in the Top right (default), top left, bottom right, or bottom left corner. |
| 6 | Back... | When Clicked closes the Marker Display Menu and returns to the Mark & Limit Menu. |

Marker More Menu

Marker More Menu

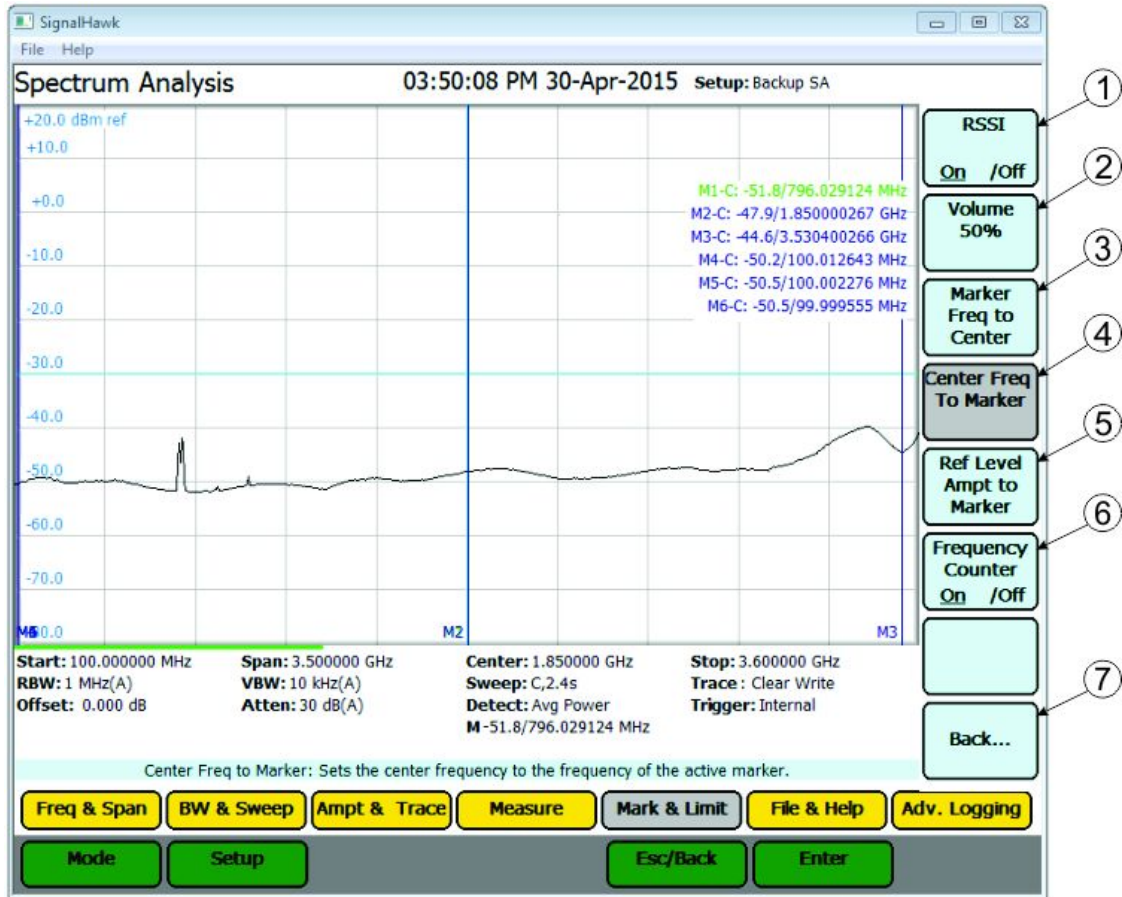

| Item | Name | Description |
|------|--------------------------|---|
| 1 | RSSI | RSSI (Received Signal Strength Indicator) Turns the audio indicator On or Off (an electronic ping). See Received Signal Strength Indicator (RSSI) . |
| 2 | Volume | Sets the volume of the electronic ping generated from the RSSI |
| 3 | Marker Freq to Center | Moves the current marker to the center frequency. |
| 4 | Center Freq to Marker | Sets the center frequency to the frequency of the active marker. |
| 5 | Ref Level Ampt to Marker | Sets the top-line amplitude reference level to the amplitude of the active marker. |

| | | |
|---|-------------------|---|
| 6 | Frequency Counter | <p>Turns the Frequency Counter on or off. This enables the frequency read out of all displayed markers to read the exact frequency of the peak within the pixel to a resolution of 1 Hz.</p> <p>NOTE Signals that vary in frequency must be within the RBW to obtain accurate results.</p> |
| 7 | Back... | <p>When Clicked closes the Marker More Menu and returns to the Mark & Limit Menu.</p> |

Limit Lines Menu

Limit lines give notification when a signal has reached or gone over a set measurement amount. Limit lines can be moved with arrow keys.

NOTE

All valid traces are black, and any part of any trace that is outside of a limit is red. Red indicates a failed limit.

Limit Lines Menu

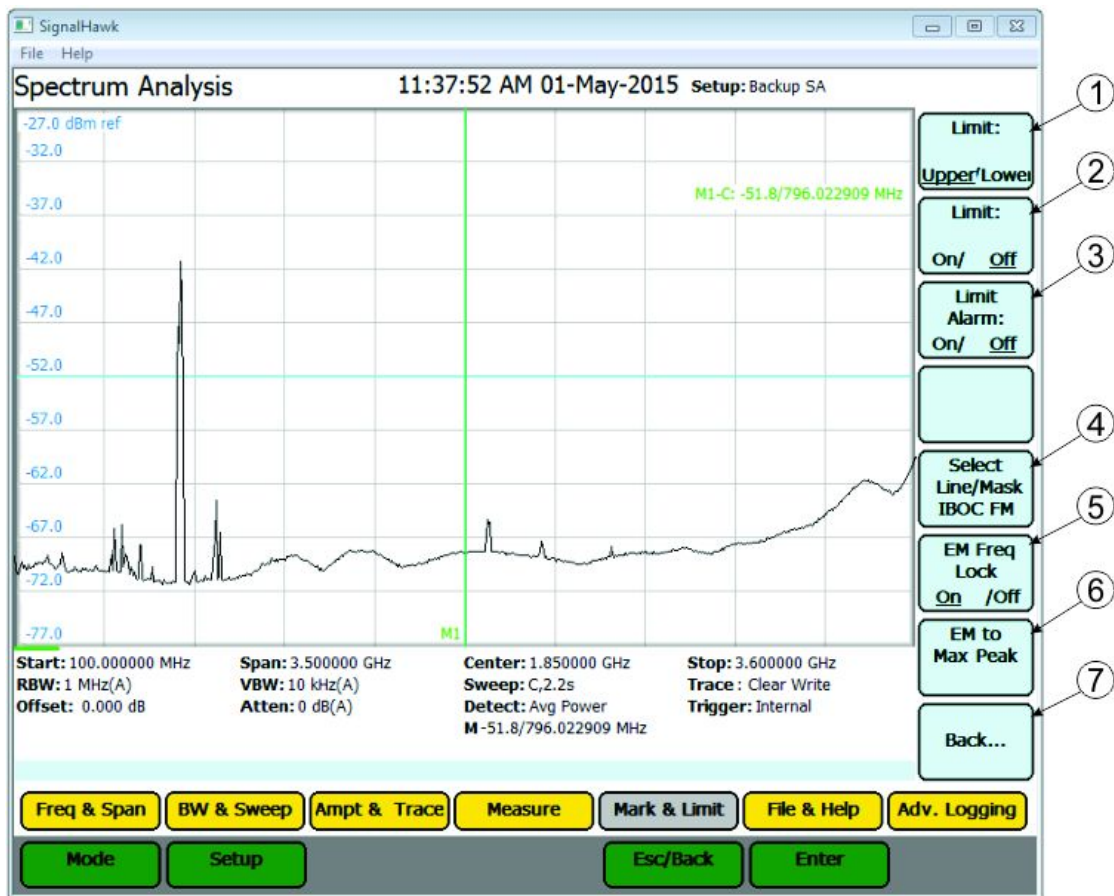

| Item | Name | Description |
|------|-------------------|---|
| 1 | Limit Upper/Lower | Allows user to select upper or lower limit line. |
| 2 | Limit On/Off | When clicked, turns limit line on or off. |
| 3 | Limit Alarm | When clicked, turns limit alarm on or off, unit beeps for limit line failure. |

| | | |
|---|------------------|---|
| 4 | Select Line/Mask | <p>Presents a list of these predefined masks to choose from including single level limit line.</p> <p>NOTE Custom Masks can be saved to the Mask list. See Customizing SignalHawk Content.</p> |
| 5 | EM Freq Lock | <p>Option available only after a mask is selected Locks the mask onto the selected band even if the frequency is changed.</p> |
| 6 | EM to Max Peak | <p>Option available only after a mask is selected Sets mask's reference level to the maximum peak in each sweep.</p> |
| 7 | Back... | <p>When Clicked closes the Limit Lines Menu and returns to the Mark & Limit Menu.</p> |

File & Help Menu

File & Help Menu

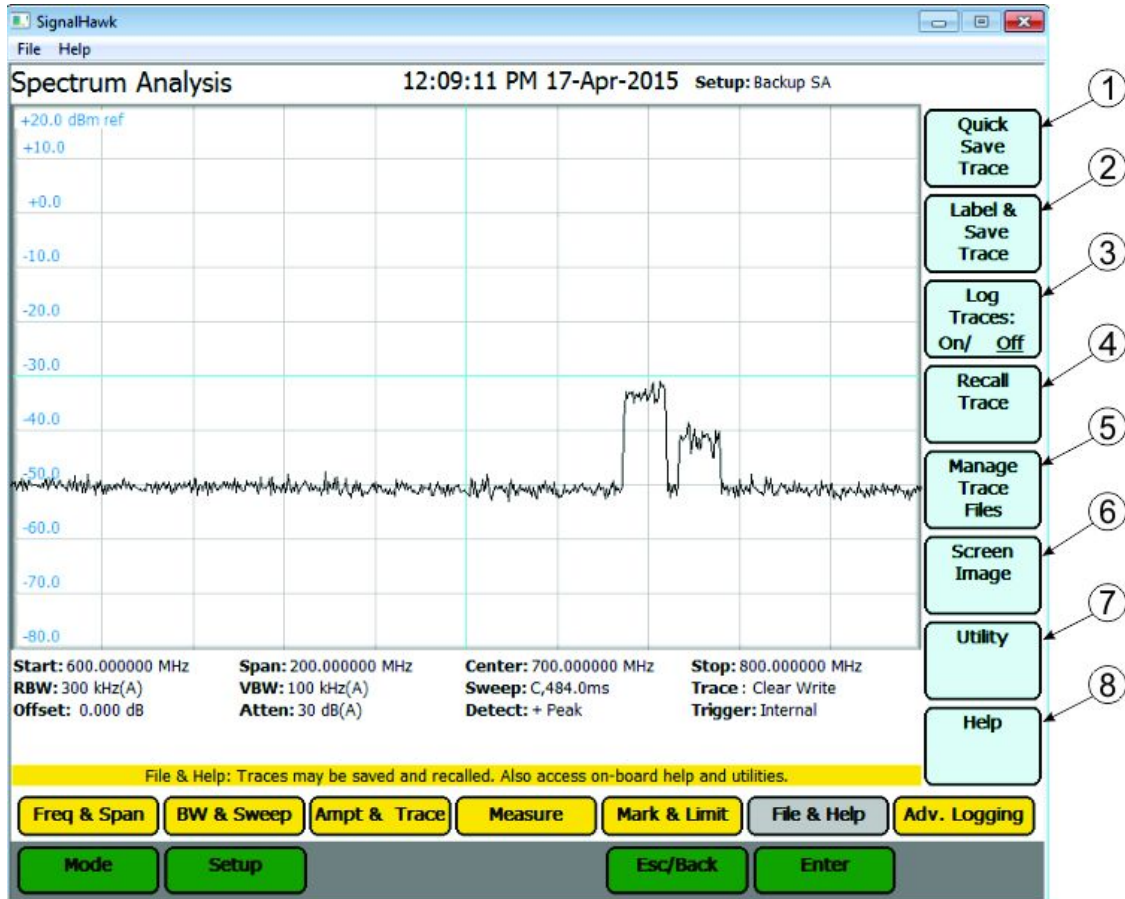

| Item | Name | Description |
|------|--------------------|---|
| 1 | Quick Save Trace | Saves the trace that is displayed on the screen. NOTE The trace is stored as a file in the default file location of the host PC. Each quick save is stored in a separate file that is named using the measurement and date-time file naming format: Measurement name(MM-DD hh-mm-ss).shf. Where MM is the month, DD is the day, hh is the hour, mm is the minute, and ss is the seconds of the time when the file was saved. |
| 2 | Label & Save Trace | Save the trace on the screen and allows the user the ability to name the file. See Label & Save Trace Menu for a detailed description. |

| | | |
|---|--------------------|---|
| 3 | Log Traces | When clicked opens the Log Traces Menu. See Log Traces Menu for a detailed description. When set to on sweeps are automatically saved at the user specified interval and a default name is assigned to each saved trace. |
| 4 | Recall Trace | When clicked opens the Recall Trace Menu. See Recall Trace Menu for a detailed description. |
| 5 | Manage Trace Files | When clicked opens the Manage Trace Files Menu. See Manage Trace Files Menu for a detailed description. |
| 6 | Screen Image | When clicked opens the Screen Image Menu. See Screen Image Menu for a detailed description. Enlarges the graph area to the size of the whole screen. Press escape to go back to regular screen. |
| 7 | Utility | See Utility Main Menu . |
| 8 | Help | Brings up the menu selections that will enable either the Quick Start Guide or the User Manual, saved in the unit. |

Label & Save Trace

Label & Save Trace

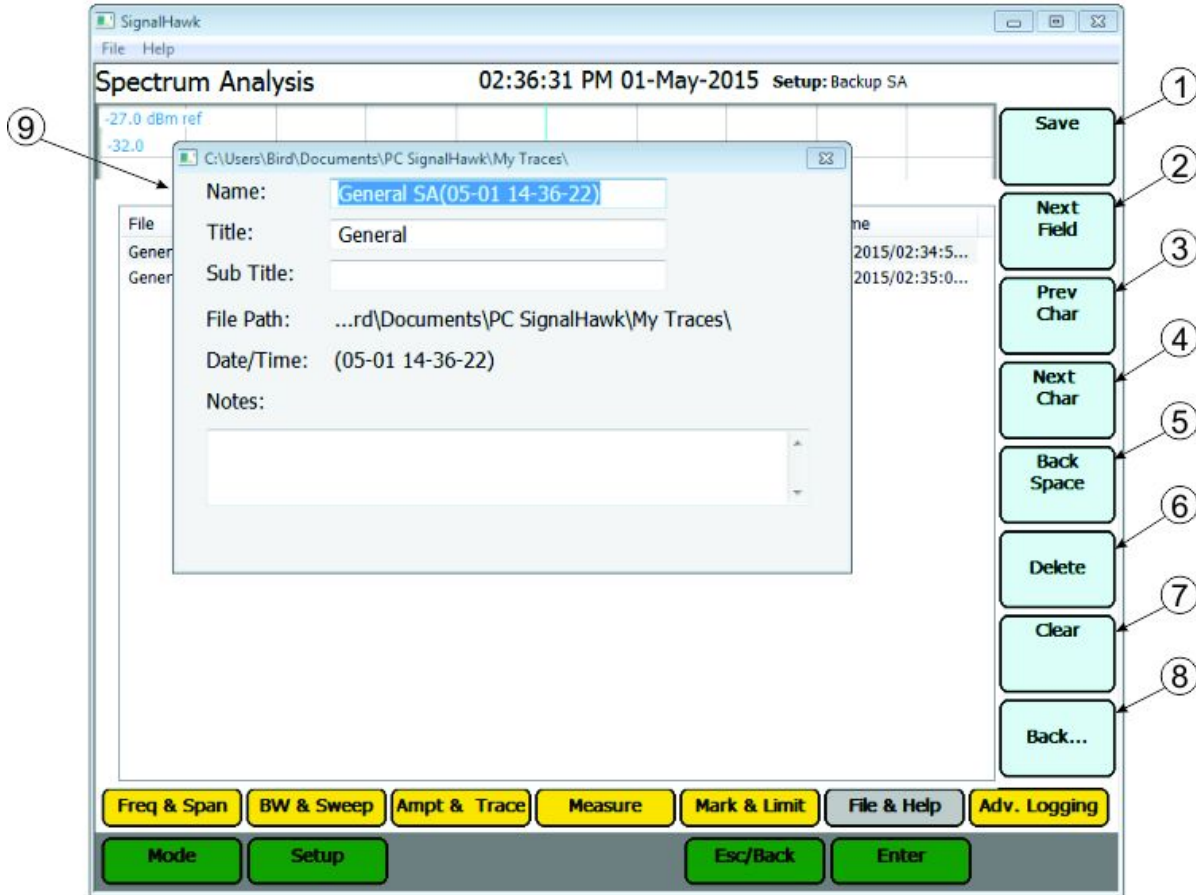

| Item | Name | Description |
|------|------------|---|
| 1 | Save | When pressed saves the Trace and closes the Label and Save Dialog Box (9). If no changes were made to the file name in the dialog box a prompt will be displayed verifying intent to overwrite the existing file. Titles, subtitles, and notes can be added to existing saved setups. |
| 2 | Next Field | When pressed advances the cursor to the next text entry field. |
| 3 | Prev Char | When pressed moves the cursor one character to the left in the active text entry field. |
| 4 | Next Char | When pressed moves the cursor one character to the right in the active text entry field. |
| 5 | Back Space | When pressed deletes the character to the left of the cursor in the active text entry field. |
| 6 | Delete | When pressed deletes the character to the right of the cursor in the active text entry field. |

| | | |
|---|---------------------------|--|
| 7 | Clear | When pressed clears all text in the active text entry field. |
| 8 | Back... | Pressing Back... will cancel the save operation and close the Label and Save Dialog Box. |
| 9 | Label and Save Dialog Box | Provides the ability to give unique names, titles, subtitles and add notes when saving a trace file. |

Log Traces Menu

Log Traces Menu

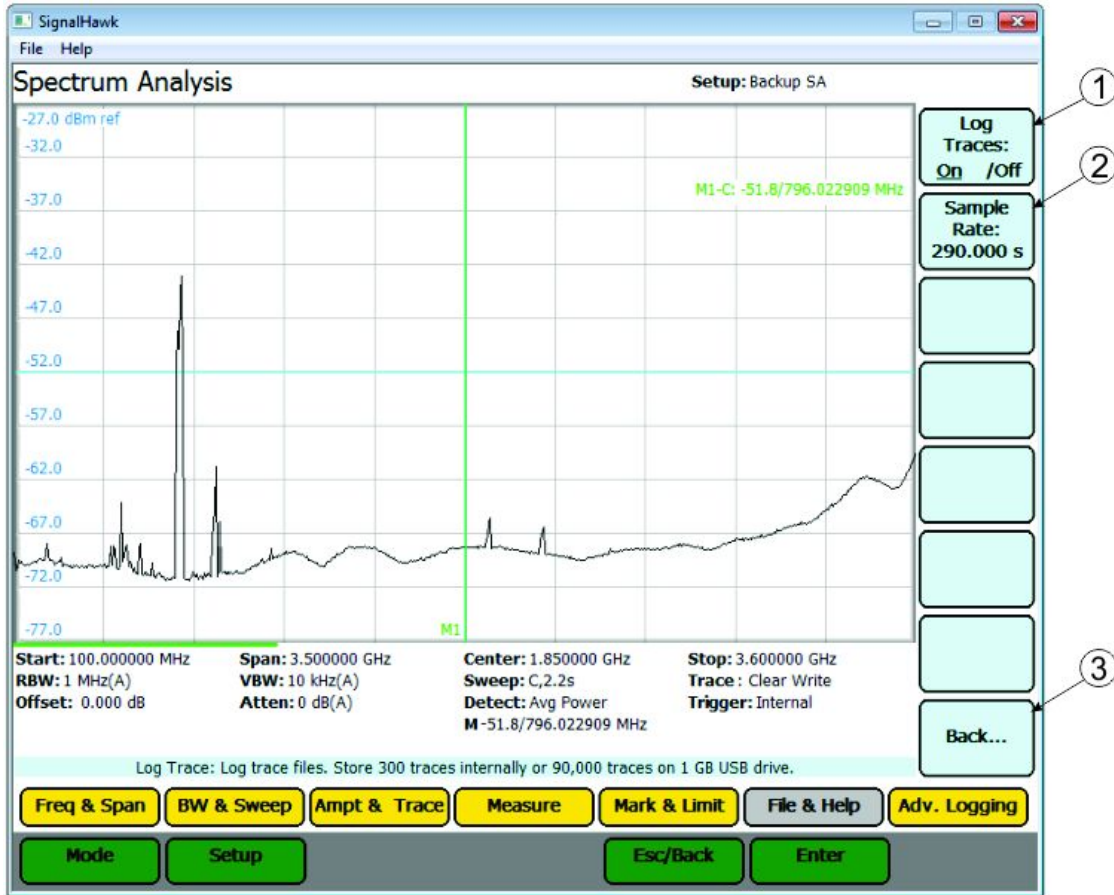

| Item | Name | Description |
|------|-------------|--|
| 1 | Log Traces | When Click turns trace auto save function on or off. When set to on sweeps are automatically saved at the interval specified in Sample Rate (2) and a default name is assigned to each save. |
| 2 | Sample Rate | Allows user to set the interval for automatically saving traces. |
| 3 | Back... | Closes the Log traces menu and returns to the File & Help Menu |

Recall Trace Menu

Recall Trace Menu

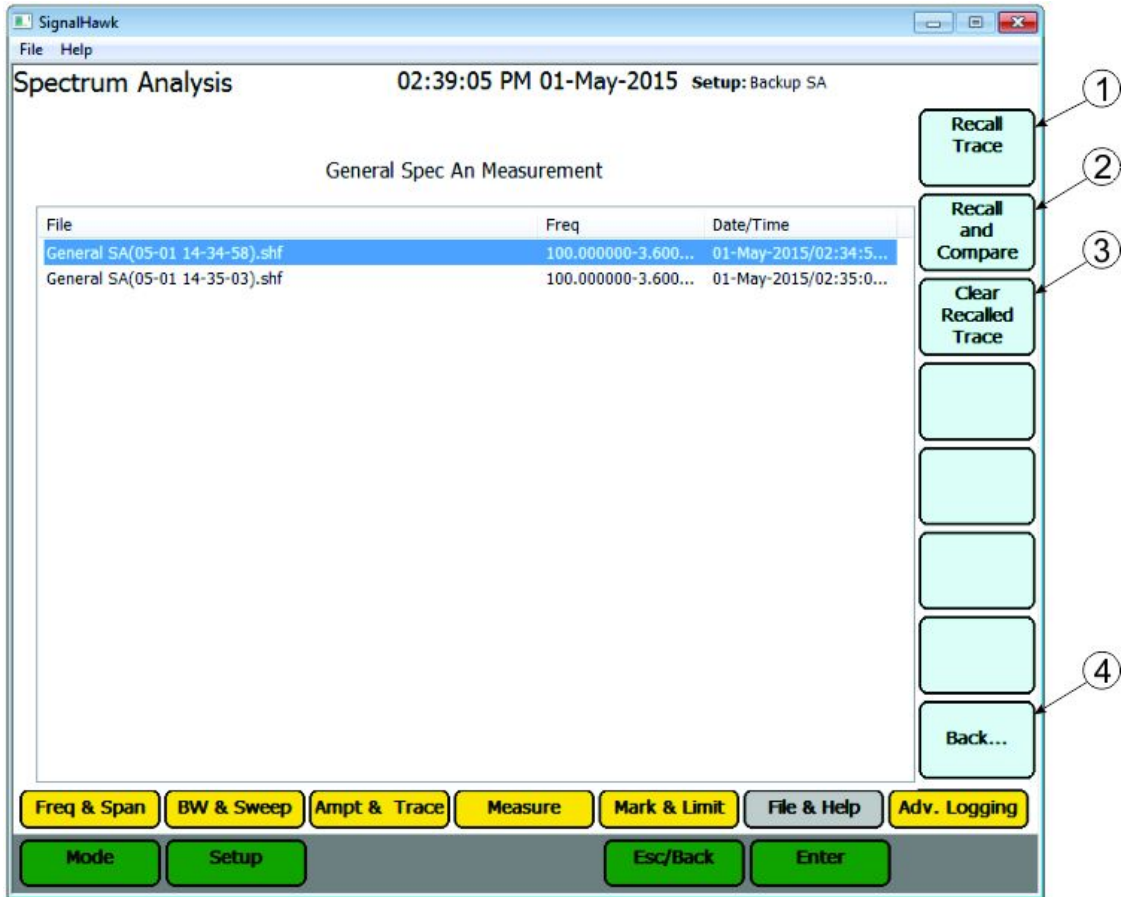

| Item | Name | Description |
|------|----------------------|--|
| 1 | Recall Trace | Displays a saved trace on the screen. |
| 2 | Recall and Compare | Displays a saved trace overlapping over the current trace on the screen. NOTE The recalled trace is orange. The current trace is black. |
| 3 | Clear Recalled Trace | Deletes the highlighted trace. |
| 4 | Back... | Closes the Recall Trace Menu and returns to the File & Help Menu |

Manage Trace Files Menu

Manage Trace Files Menu

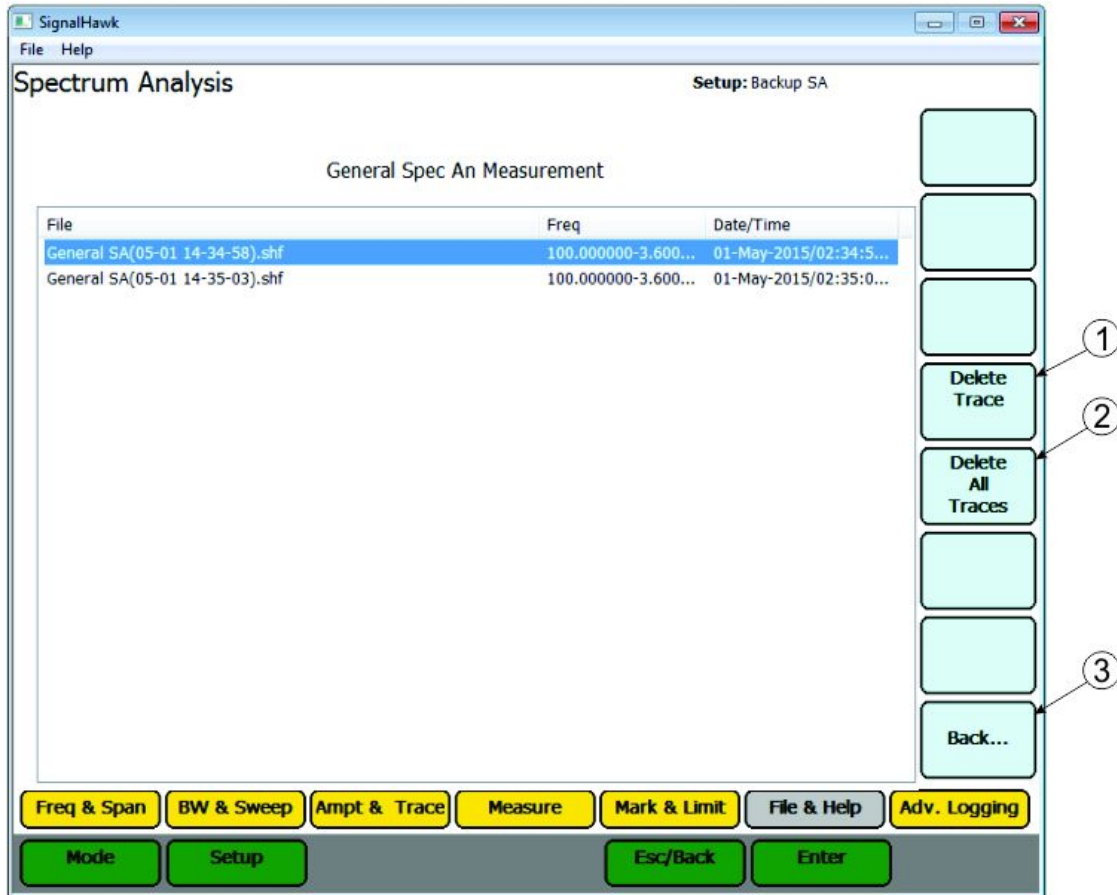

| Item | Name | Description |
|------|-------------------|--|
| 1 | Delete Trace | When clicked deletes the highlighted saved trace file. |
| 2 | Delete All Traces | When clicked deletes all the saved trace file. |
| 3 | Back... | Closes the Manage Trace Files Menu and returns to the File & Help Menu |

Screen Image Menu

Screen Image Menu

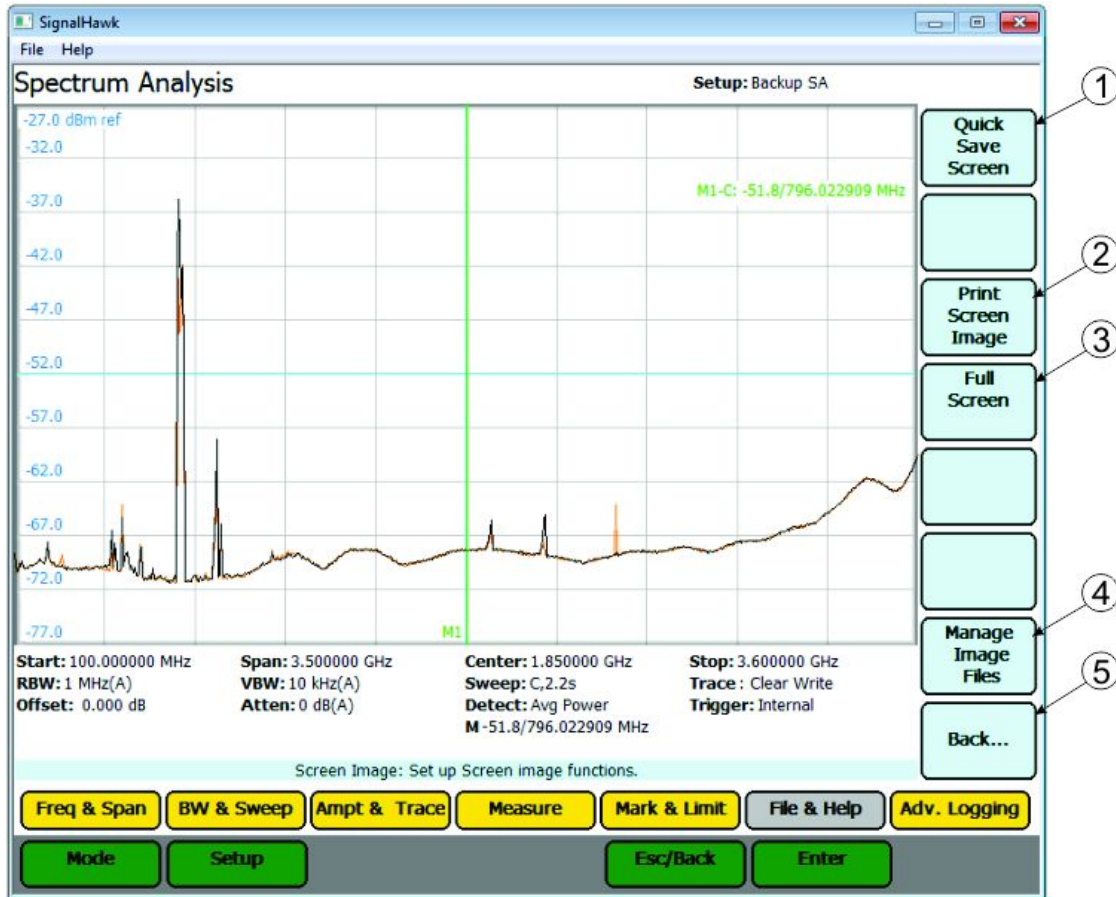

| Item | Name | Description |
|------|--------------------|---|
| 1 | Quick Save Screen | When clicked save a screen shot of the current display. |
| 2 | Print Screen Image | When clicked displays a print dialog for printing the current display. |
| 3 | Full Screen | Enlarges the graph to fill the entire screen. Press ESC to return to normal view. |
| 4 | Manage Image Files | When clicked displays Manage Image Files Menu. This Menu is similar to the Manage Trace Files Menu. |
| 5 | Back... | Closes the Screen Image Menu and returns to the File & Help Menu |

Adv. Logging Menu

The following paragraphs describe the menu options available on the Advanced Spectrum Logging Menu.

Advanced Spectrum Logging (ASL)

The Advanced Spectrum Logging (ASL) feature for the Signal Hawk allows the user to collect traces from the unit over a long period of time. These traces can then be played back as if they were being viewed in real time, allowing the user to identify anomalies in the spectrum that coincide with different events, such as illegal carrier events, system performance degradation, or alarm triggers. This information is usually used to troubleshoot a system experiencing intermittent events.

The ASL feature requires that the computer running the software be equipped with Microsoft SQL Server. The ideal installation for this setup is 2008 R2, but it could possibly be run on later versions.

NOTE

Using SQL server prior to 2008 is not recommend.

In order to utilize the ASL perform the following actions:

1. Create a configuration file, which sets up the parameters for multiple sweeps. See [Create a configuration file](#).
2. Create a new database in order to start recording data. See [Create a Database](#).
3. Start Spectrum Trace Logging. Once a configuration has been created and a database attached, trace logging can be started. See [Spectrum Trace Logging](#).
4. Playback. Once data is recorded in the attached database, you may also open the unit for playback. See [Spectrum Trace Playback](#).
5. Search Database. Once data is recorded in the attached database, you may search the database using masks and limit lines to identify intermittent events. See [Database Search](#).

Adv. Logging — Database/Configuration Menu

Adv. Logging — Database/Configuration Menu



| Item | Name | Description |
|------|------------------------|---|
| 1 | Create New Database | When Clicked, Opens the dialog for selecting a configuration file and creating a new database. For detailed information see Create a Database . |
| 2 | Load Existing Database | When Clicked, Opens the dialog for selecting a previously saved database. For detailed information see Attach an Existing Database . |
| 3 | Use Current Database | When Clicked, verifies a database is attached. If no database is attached a message is displayed notifying the user. If a database is attached, the Adv. Logging — Logging/Playback Menu is displayed. |

| | | |
|---|-------------------------|--|
| 4 | Detach Current Database | <p>When Clicked, detaches the attached database. If no database was attached a message is displayed indicating no database was attached.</p> <p>NOTE To use Advanced Spectrum Logging a database must be attached.</p> |
| 5 | Create New Config. | <p>When Clicked, displays the Configuration Settings Dialog Box. See Configuration Settings Dialog Box</p> |
| 6 | Reload/Update Config. | <p>When Clicked, displays a list of available configuration files.</p> |
| 7 | Back... | <p>Closes the Adv. Logging — Database/Configuration Menu and opens the Adv. Logging — Logging/Playback Menu.</p> <p>NOTE Adv. Logging — Logging/Playback Menu will only open once a database is attached. see Create a Database or Attach an Existing Database.</p> |

Adv. Logging — Logging/Playback Menu

Adv. Logging — Logging/Playback Menu

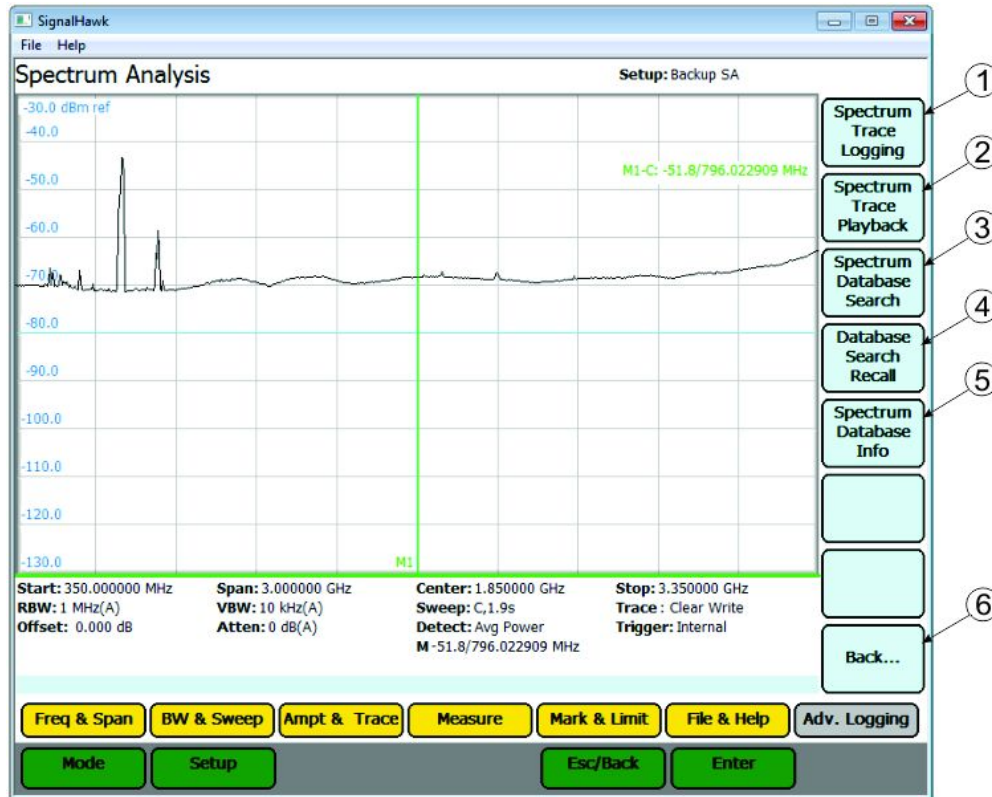

| Item | Name | Description |
|------|--------------------------|---|
| 1 | Spectrum Trace Logging | When clicked, Opens the Sweep Logging Menu. See Sweep Logging Menu for a detailed description. |
| 2 | Spectrum Trace Playback | When clicked displays the Sweep Playback Menu. See Sweep Playback Menu for a detailed description. |
| 3 | Spectrum Database Search | When clicked, Opens the Database Search Menu. See Database Search Menu for a detailed explanation. |
| 4 | Database Search Recall | When clicked open the database recall dialog box. See Database Search Recall Playback Menu for a detailed explanation for playback of recalled search data. |
| 5 | Spectrum Database Info | When clicked, displays information about the currently attached database, including configuration name, Site Name, Operator Name, Creation date and time, and Trace Logging start and stop date and time. |
| 6 | Back... | Closes the Adv. Logging — Logging/Playback Menu and opens the Adv. Logging — Database/Configuration Menu |

Sweep Logging Menu

Sweep Logging Menu

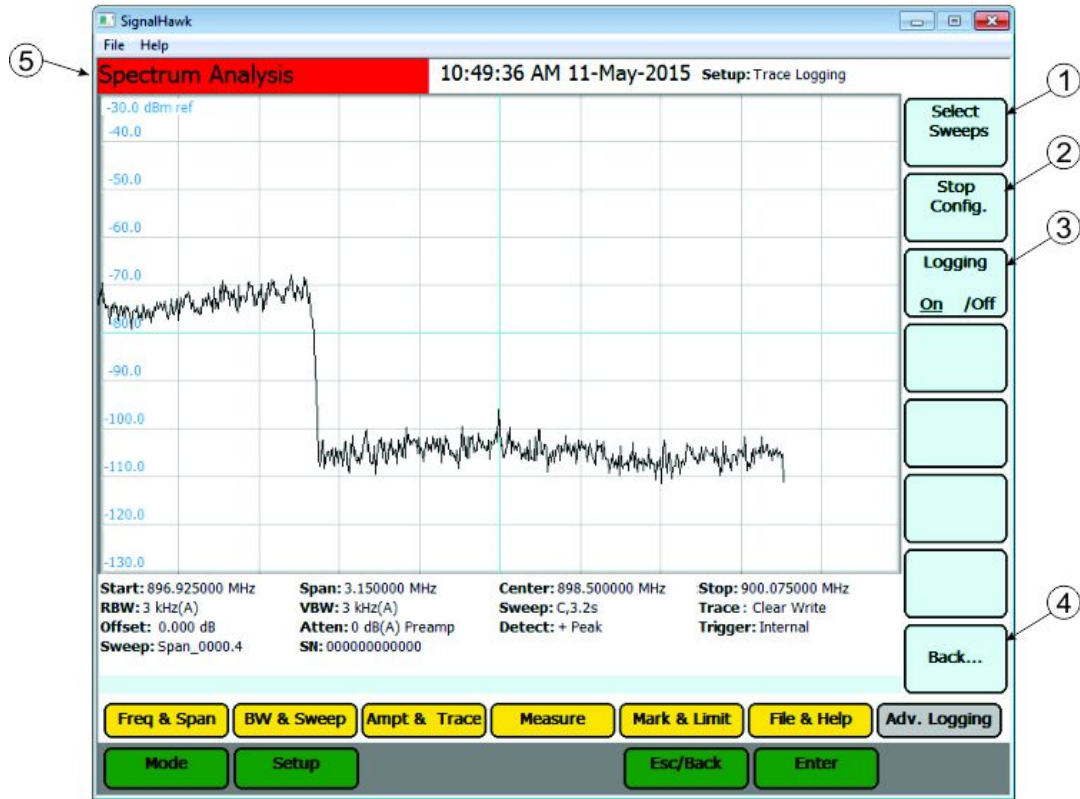

| Item | Name | Description |
|------|--------------------|--|
| 1 | Select Sweeps | When clicked, Opens the Sweep selection dialog box. See Select Sweeps Dialog Box for a detailed description. |
| 2 | Start/Stop Config. | This option button is an alternate action button. When Start config. is clicked, the selected sweeps begin to be displayed and Stop Config. is displayed on the option button. NOTE Sweep Logging to the database does not begin until the Logging On (3) option is depressed. |
| 3 | Logging On/Off | This option button is an alternate action button. When clicked, database logging is started or stopped. The active option is underlined. NOTE Not displayed until Start Config. is depressed. |
| 4 | Back... | Closes the Adv. Logging — Logging/Playback Menu and opens the Adv. Logging — Database/Configuration Menu |
| 5 | Red Background | The red background indicates sweep logging is active. |

Sweep Playback Menu

Sweep Playback Menu

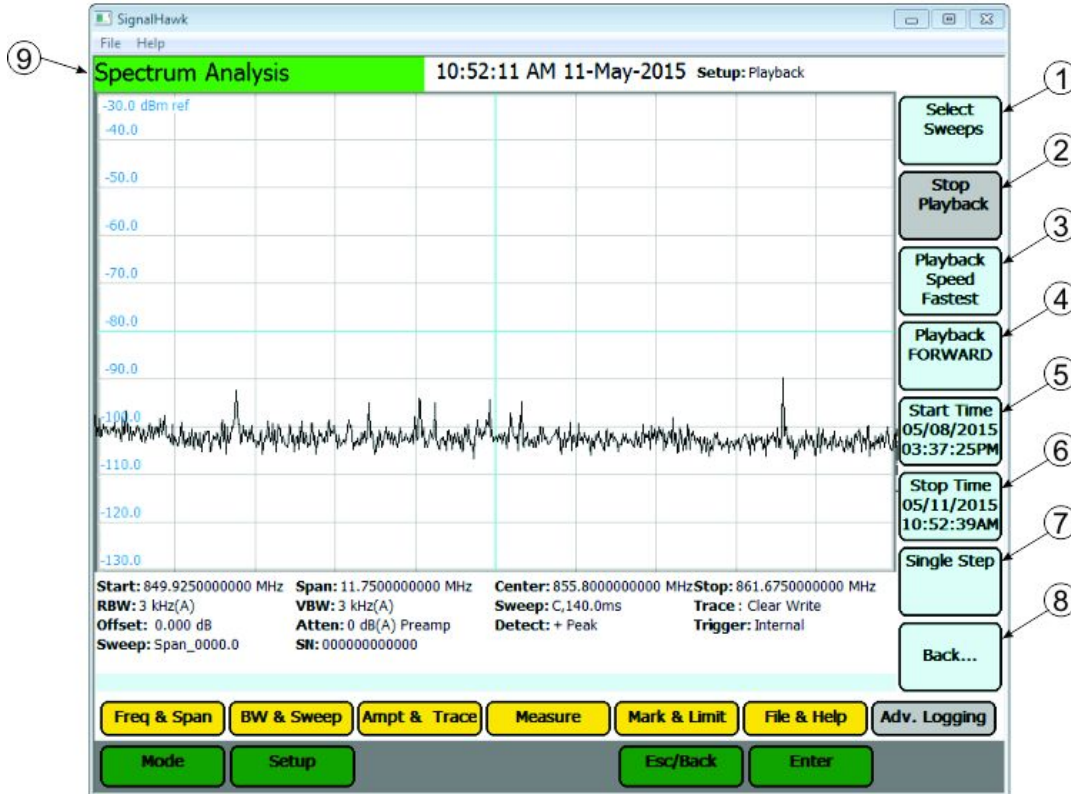

| Item | Name | Description |
|------|---------------------|--|
| 1 | Select Sweeps | When clicked, Opens the Sweep selection dialog box. See Select Sweeps Dialog Box for a detailed description. |
| 2 | Start/Stop Playback | <p>This button toggles between playback and live sweep mode. This option button is an alternate action button. Start Playback is displayed when playback is stopped. Stop Playback is displayed while playback is running.</p> <p>NOTE</p> <ul style="list-style-type: none"> When in playback mode, the upper left hand corner of the screen where it says Spectrum Analysis will have a green background. When playback is stopped the system resumes displaying real time spectrum traces. Be careful to not confuse these traces with previously recorded data. |

| | | |
|---|-----------------------------|--|
| 3 | Playback Speed | <p>When clicked, changes the playback speed. Speed may be adjusted by clicking on the box, using the arrow keys, or using a scroll wheel on a mouse. The options are Slowest, Slow, Medium, Fast, Fastest.</p> <p>NOTE Not displayed until a sweep is selected.</p> |
| 4 | Playback FORWARD/REVERSE | <p>This option button is an alternate action button. When clicked, changes the sweep playback direction.</p> <p>NOTE Not displayed until a sweep is selected.</p> |
| 5 | Start Time | <p>Displays the beginning date and time of the recorded data for the selected sweep. Default value is the start time of data in the database. When clicked, user may set a new start time to limit the playback parameters. When the time is changed, the sweep will automatically revert to the start time. When you reach the end of the file (or beginning of the file while in Reverse), you will be asked whether you want to start over from the Start time (or stop time in reverse).</p> <p>NOTE Not displayed until a sweep is selected.</p> |
| 6 | Stop Time | <p>Displays the end date and time of the recorded data for the selected sweep. Default value is the stop time of data in the database. When clicked, user may set a new stop time to limit the playback parameters. When the time is changed, the sweep will automatically revert to the start time. When you reach the end of the file (or beginning of the file while in Reverse), you will be asked whether you want to start over from the Start time (or stop time in reverse).</p> <p>NOTE Not displayed until a sweep is selected.</p> |
| 7 | Single Step | <p>When clicked, This button pauses the playback and advances it one step in either the forward or reverse direction.</p> <p>NOTE Not displayed until a sweep is selected.</p> |
| 8 | Back... | <p>Closes the Sweep Playback Menu and opens the Adv. Logging — Logging/Playback Menu.</p> |
| 9 | Green Background | <p>The green background indicates sweep playback is active.</p> |

Database Search Menu

Database Search Menu

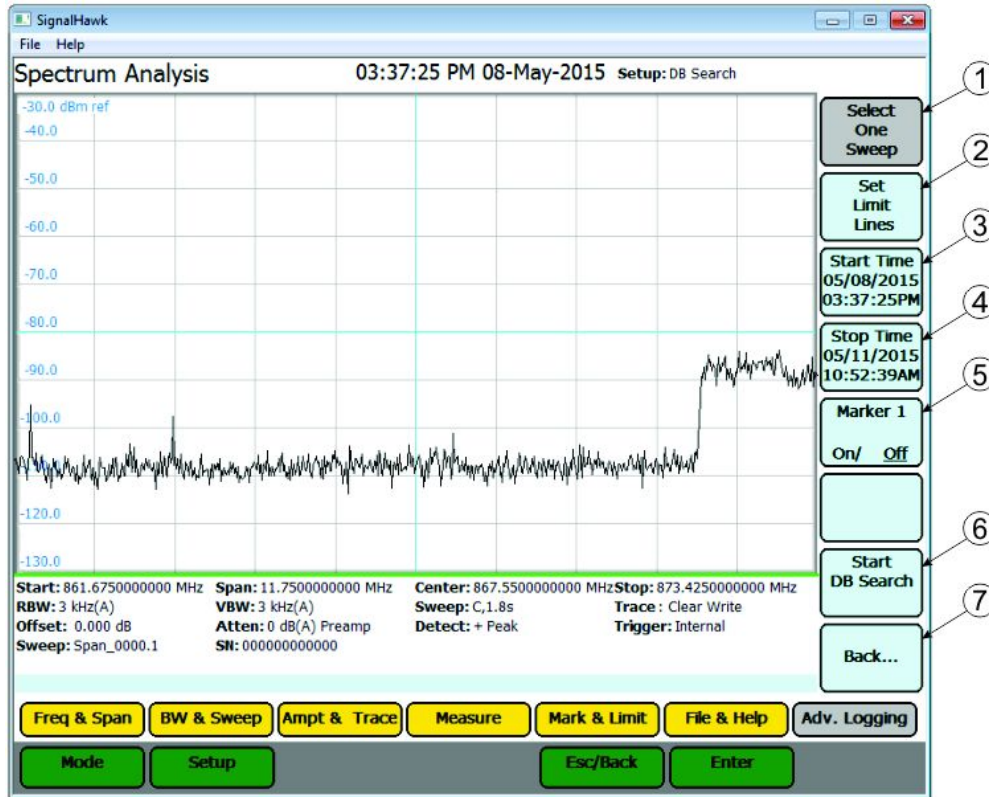

| Item | Name | Description |
|------|------------------|--|
| 1 | Select One Sweep | When clicked, Opens the Sweep selection dialog box. See Select Sweeps Dialog Box for a detailed description. |
| 2 | Set Limit Lines | When clicked, opens the limit lines menu. Limit lines and masks are used to define database search criteria. See Database Search—Limit Lines Menu for a detailed description. |
| 3 | Start Time | Displays the beginning date and time of the recorded data for the selected sweep. Default value is the start time of data in the database. When clicked, user may set a new start time to limit the search parameters. NOTE Not displayed until a sweep is selected. |

| | | |
|---|-----------------|--|
| 4 | Stop Time | <p>Displays the end date and time of the recorded data for the selected sweep. Default value is the stop time of data in the database.</p> <p>When clicked, user may set a new stop time to limit the search parameters.</p> <p>NOTE Not displayed until a sweep is selected.</p> |
| 5 | Marker 1 | When clicked, turns Marker 1 display on or off. |
| 6 | Start DB Search | When clicked searches the database for any trace signal data that falls outside limit line or mask criteria. |
| 7 | Back... | Closes the Database Search Menu and opens the Adv. Logging — Logging/Playback Menu |

Database Search — Limit Lines Menu

Database Search — Limit Lines Menu

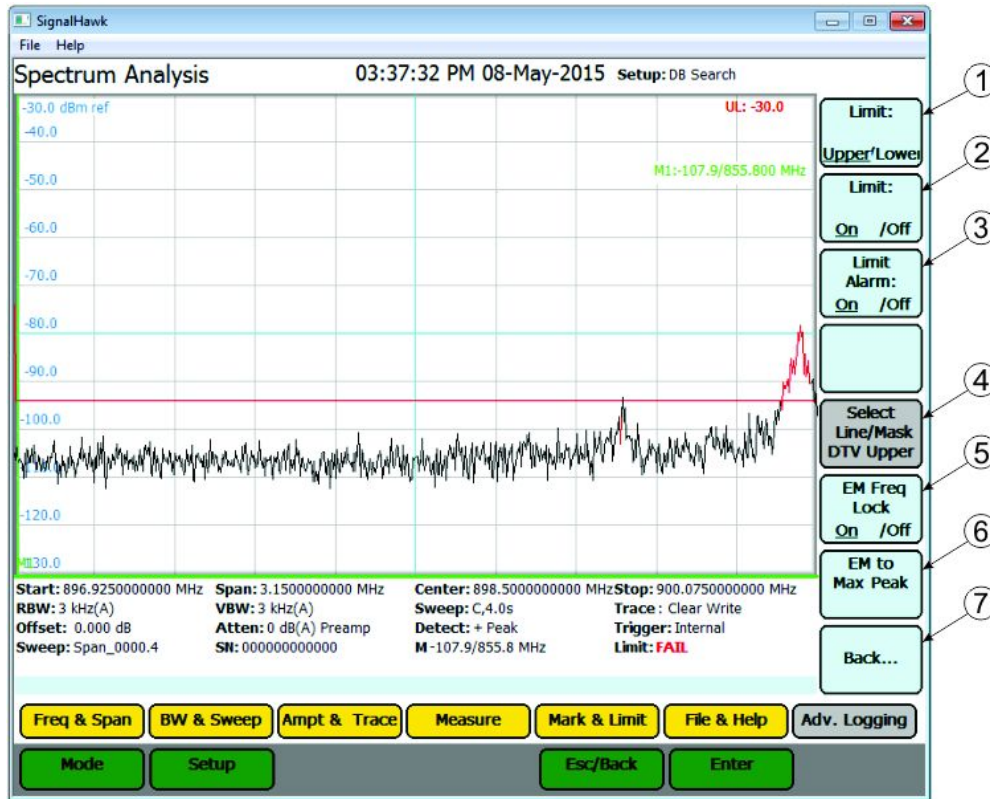

| Item | Name | Description |
|------|--------------------|--|
| 1 | Limit: Upper/Lower | When clicked, toggles between selection of the upper or lower limit line. |
| 2 | Limit: On/Off | When clicked, turns Selected Limit Line On or Off. |
| 3 | Limit Alarm On/Off | When clicked, turns limit alarm on or off, unit beeps for limit line failure. |
| 4 | Select Line/Mask | Creates a specific set of limit lines and presents a list of these predefined masks to choose from. NOTE Custom Masks can be saved to the Mask list. See Creating Database Search Limit Masks . |
| 5 | EM Freq Lock | Option available only after a mask is selected Locks the mask onto the selected band even if the frequency is changed. |
| 6 | EM to Max Peak | Option available only after a mask is selected Sets mask's reference level to the maximum peak in each sweep. |

| | | |
|---|---------|--|
| 7 | Back... | Closes the Database Search — Limit Lines Menu and opens the Adv. Logging — Logging/Playback Menu |
|---|---------|--|

Database Search Recall Playback Menu

Database Search Recall Playback Menu

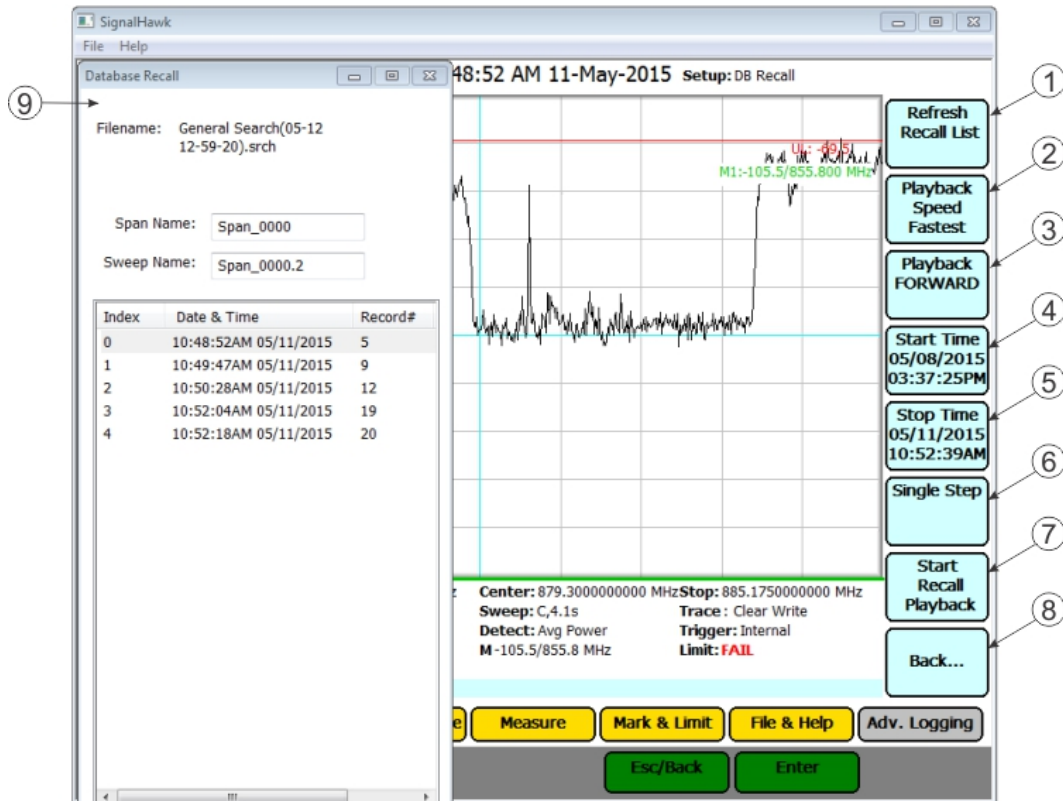

| Item | Name | Description |
|------|--------------------------|--|
| 1 | Refresh Recall List | When clicked, refreshes the Database Recall Dialog Box. |
| 2 | Playback Speed | When clicked, changes the playback speed. Speed may be adjusted by clicking on the box, using the arrow keys, or using a scroll wheel on a mouse. The options are Slowest, Slow, Medium, Fast, Fastest. |
| 3 | Playback FORWARD/REVERSE | This option button is an alternate action button. When clicked, changes the sweep playback direction. |

| | | |
|---|-------------------------------|--|
| 4 | Start Time | Displays the beginning date and time of the recorded data for the selected sweep. Default value is the start time of data in the database. When clicked, user may set a new start time to limit the playback parameters. When the time is changed, the sweep will automatically revert to the start time. When you reach the end of the file (or beginning of the file while in Reverse), you will be asked whether you want to start over from the Start time (or stop time in reverse). |
| 5 | Stop Time | Displays the end date and time of the recorded data for the selected sweep. Default value is the stop time of data in the database. When clicked, user may set a new stop time to limit the playback parameters. When the time is changed, the sweep will automatically revert to the start time. When you reach the end of the file (or beginning of the file while in Reverse), you will be asked whether you want to start over from the Start time (or stop time in reverse). |
| 6 | Single Step | When clicked, This button pauses the playback and advances it one step in either the forward or reverse direction. |
| 7 | Start/Stop Recall Playback | <p>This button toggles between playback and live sweep mode. This option button is an alternate action button. Start Playback is displayed when playback is stopped. Stop Playback is displayed while playback is running.</p> <p>NOTE</p> <ul style="list-style-type: none"> • When in playback mode, the upper left hand corner of the screen where it says Spectrum Analysis will have a green background. • When playback is stopped the system resumes displaying real time spectrum traces. Be careful to not confuse these traces with previously recorded data. |
| 8 | Back... | Closes the Database Search Recall Playback Menu and opens the Adv. Logging — Logging/Playback Menu |
| 9 | Database Recall Dialog Box | Displays a list of trace records within the database that matched the limits specified in the search criteria. |

Configuration Settings Dialog Box

Configuration Settings Dialog Box

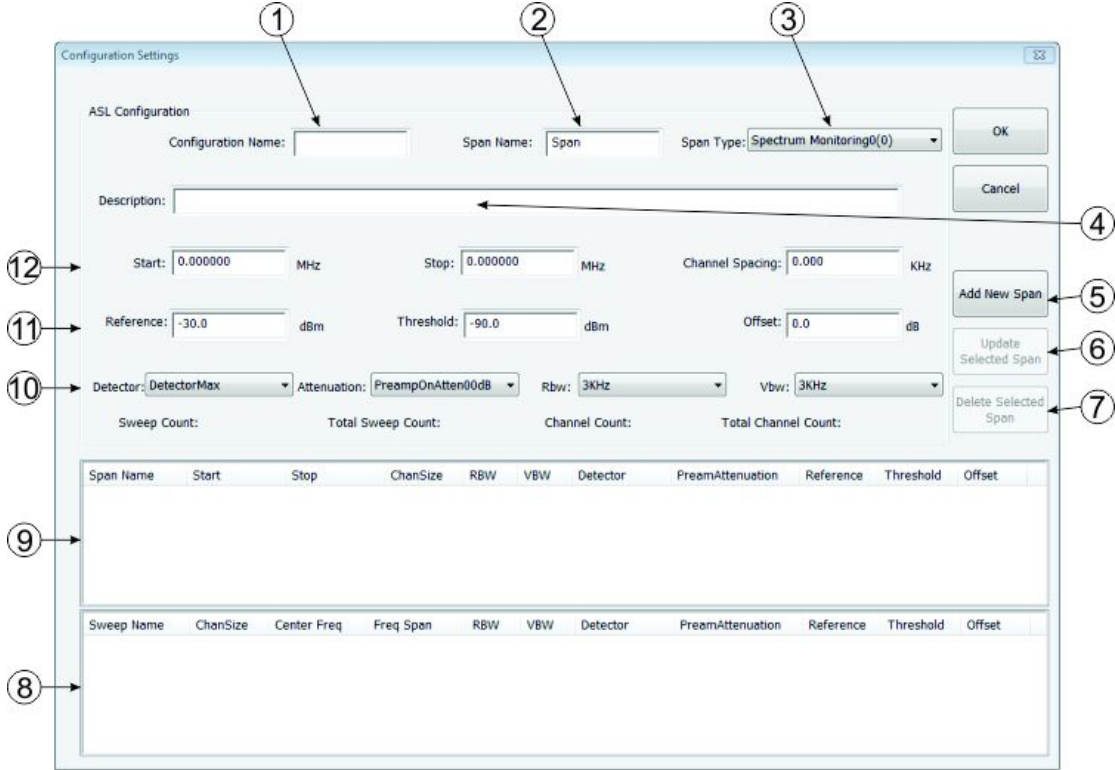

| Item | Name | Description |
|------|--------------------|--|
| 1 | Configuration Name | This is the name of the configuration and is used as the file name for the .csv file. |
| 2 | Span Name | Enter Span Name, each span can have a unique name. |
| 3 | Span Type | <p>There are five options in Span Type (Spectrum Monitoring 0 - 4000). Different Span Types are often used for different sets of data collection. This selects which span setting to use. Spans can be arranged into groups identified by the Span Type.</p> <p>Example - Each Span Type can hold the frequency plan for a different site allowing multiple frequency plans to be contained in a single Configuration file.</p> <p>NOTE Different Span Types are usually used for mutually exclusive spans that are not normally run together.</p> |
| 4 | Description | Plain text description of the configuration. |

| | | |
|----|----------------------|---|
| 5 | Add New Span | When clicked, adds the span information into the Span and Sweep tables (8 and 9). |
| 6 | Update Selected Span | When clicked, displays the configuration settings for the span selected in the Span table (9). |
| 7 | Delete Selected Span | When clicked, deletes the span selected in the Span table (9). |
| 8 | Sweep Table | This table lists all the individual sweeps and what spans they are associated with. NOTE As noted before, if there are more than 235 channels between the start and stop frequencies, a span will have multiple sweeps. |
| 9 | Span Table | This table lists all the individual spans that have been entered, as well as the settings for those spans. NOTE If you need to edit a span, simply click on that span, modify the fields, and click on Update Selected Spans. |
| 10 | Detector | This sets the type of detection used in the sweeps. NOTE DetectorMax or DetectorAverage are suggested. See Detection Mode Menu in Settings. |
| | Attenuation/Preamp | This sets the internal preamplification/attenuation settings used by the sweep. The preamp and the attenuation are mutually exclusive. When the preamplifier is turned on, the attenuation will be reset to 0. Conversely, if attenuation is turned on, the preamplifier will be turned off. NOTE The pre-amp is not suggested for signals in excess of -40 dBm at the input of the Signal Hawk. |
| | RBW/VBW | These represent the resolution bandwidth and video bandwidth of the sweep. NOTE Narrower Bandwidth settings slow the traces down, but provides more detail about the observed signal. Both Bandwidth settings should be narrower than the channel spacing. |

| | | |
|----|------------|--|
| 11 | Reference | <p>This is the level set at the top of the screen.</p> <p>NOTE When collecting data, the Signal Hawk automatically uses 10 dB/division on the screen.</p> <p>If resolution down to the channel level is not required and the user desires to monitor a large span in a single sweep, then simply make the channel spacing large enough so that the program saves the span as a single sweep.</p> |
| | Threshold | <p>For advanced applications, this is the level in which a particular channel would be considered “active.”</p> <p>NOTE This has no effect on playback.</p> |
| | Offset | <p>For systems with a known offset, you can enter it here to de-embed the reading.</p> <p>NOTE Positive offsets represent coupling or attenuation loss, while negative offsets represent gain from amplification.</p> <p>Used to compensate for signal gain or loss between the spectrum analyzer and the desired measurement point.</p> <p>Example - to remove the gain of a multicoupler when signal level from the antenna is the desired data.</p> |
| 12 | Start/Stop | <p>Enter the center frequencies of the channels the SignalHawk will start and stop on.</p> <p>NOTE The Signal Hawk ASL will automatically include a buffer channel on either side of the start and stop frequency (as defined by the Channel Spacing).</p> <p>The Signal Hawk ASL adjusts the start and stop frequencies of each span to the lower and upper channel edges as defined by the Channel Spacing. This insures that each span includes the entire first and last channel.</p> |

| | | |
|--|-----------------|---|
| | Channel Spacing | <p>For the sake of data resolution, this is the channel center to channel center spacing in the band of interest. In some parts of the spectrum the channel to channel spacing changes. In these cases, separate spans will be required if locating the individual channel centers in the recorded data is desired.</p> <p>NOTE The SignalHawk ASL is designed to provide enough resolution to view every channel in a span. This requires a minimum of three data points per channel. The SignalHawk has 705 data points within each sweep therefore, a span that contains more than 235 channels (as defined by channel spacing) will automatically be broken into multiple sweeps (705 points /3 points per channel minimum).</p> |
|--|-----------------|---|

Select Sweeps Dialog Box

Select Sweeps Dialog Box

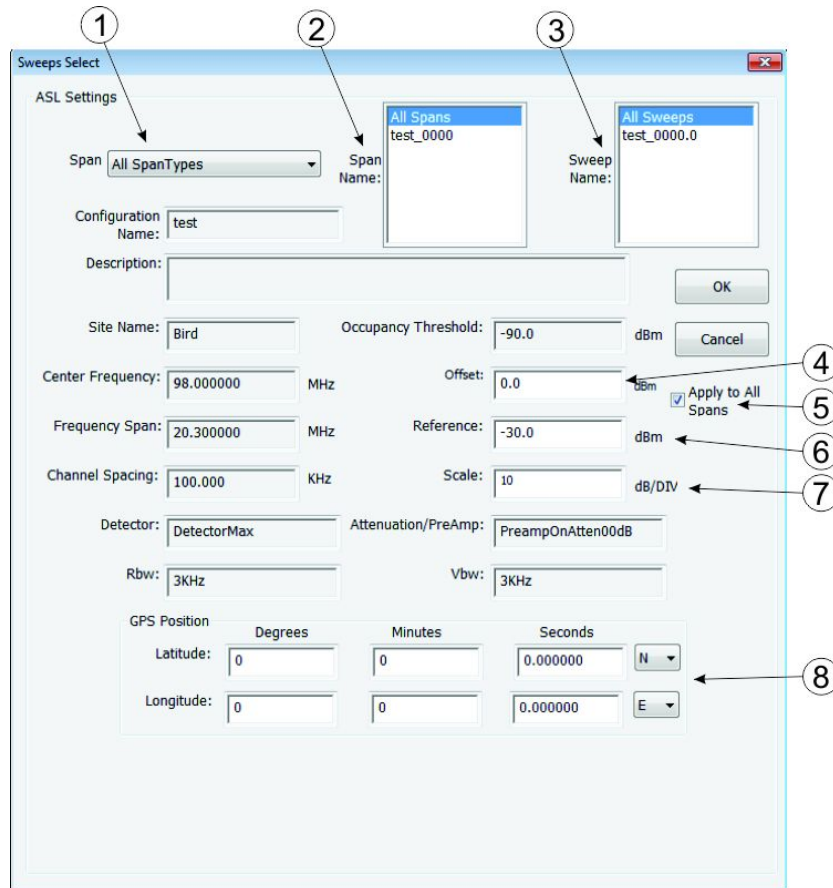

| Item | Name | Description |
|------|-----------|--|
| 1 | Span Type | <p>This Span Type corresponds to the Span Types used to Configure the spans (see Configuration Settings Dialog Box). There are five options in Span Type (Spectrum Monitoring 0 - 4000).</p> <p>The Scan Type selection will determine what spans and sweeps are displayed in the Span Name (2) and Sweep Name (3) selection lists.</p> <p>NOTE Do not select "All Span Types" unless you are certain there are no conflicts between the different groups of spans. Collecting data from more than one Span Type at the same time is strongly discouraged.</p> |

| | | |
|---|--------------------|---|
| 2 | Span Name | <p>Displays a list of all the saved spans available for the Span Type (1) selected.</p> <p>NOTE Selecting All Spans, will allow selection of sweeps (3) from any of the spans in the selected Span Type (1).</p> |
| 3 | Sweep Name | <p>Displays a list of all the saved Sweeps available for the selected span (2).</p> |
| 4 | Offset | <p>You can set an offset for the reading, just like a standard spectrum analyzer. This offset allows you to correct for gain through amplifiers or loss through couplers, in order to see readings at different points in the system.</p> <p>NOTE The value entered here will override the offset value entered when the Configuration was created.</p> |
| 5 | Apply to All Spans | <p>Selecting "Apply to All Spans" check box, will apply the offset to all spans in the current Span Type.</p> |
| 6 | Reference | <p>This is the level set at the top of the screen.</p> |
| 7 | Scale | <p>The scale per division on the screen. Available range is 1 through 15.</p> |
| 8 | GPS Position | <p>Enter Latitude and Longitude, if desired.</p> <p>NOTE The GPS Data will automatically populate if an accessory USB GPS device is used and it can obtain a GPS position fix. In addition, if the ASL is being used in a mobile environment the GPS location for each sweep will be written into the database as the data is collected.</p> |

Create Configuration File

NOTE

For the purposes of an ASL configuration, a sweep is a contiguous block of frequencies, (one sweep of the analyzer). A span is a collection of sweeps and a Configuration is a collection of spans.

Configuration files tell the system what bands to monitor. Normally, Configuration files include one or more sweeps, each with their own settings, such as span, channel bandwidth, and sampler settings. If multiple sweeps are used when collecting data, the unit will cycle through each sweep, returning to the first sweep after all sweeps have been collected.

NOTE

Increasing the number of sweeps when collecting data will increase the time between each particular sweep. Use of more than 100 sweeps is not recommended.

1. Click on the Adv. Logging Menu button.
2. Click Create New Config. option on the Adv. Logging — Database/Configuration Menu

NOTE

If a database is currently attached, the Adv. Logging button will automatically enter the Adv. Logging — Logging/Playback Menu, click the Back... button to enter the correct menu.

3. Enter the Configuration Settings for a new span. See [Configuration Settings Dialog Box](#) for an explanation of the text boxes.
4. Click the Add New Span button to save the new span settings.

NOTE

The new span and sweep will be added to the Span and Sweep tables. If the new span exceeds 235 channels as defined by the channel spacing, the span will be broken up into multiple sweeps. These sweeps will appear in the sweep table.

- Repeat Steps 2 through 4 until all of the desired frequency spans have been entered.

NOTE

If a mistake is made, the span can be edited or deleted. Individual sweeps cannot be edited or deleted. Changes are made to the span and then the system will update the sweeps automatically.

- Change a span.
 - Select the appropriate span in the Span Table.
 - Change the settings.
 - Click on Update Selected Span.
- Delete a span

Select the appropriate span in the Span Table.
Click on Delete Selected Span.

- Click the OK button to save the changes.

NOTE

- When you click on OK to save the new configuration file, you will be prompted to create a new database. A new database must be created whenever a new configuration file is created or when changes are made to an existing configuration file. You cannot log data obtained from two different configuration files into the same database.
- Default location for saved configuration files is My Documents > PC SignalHawk > ASL > My Configurations folder. Configuration files are saved as CSV files.

- Create a new Database. See [Create a Database](#).

Edit Configuration Files

NOTE

Editing CSV files in other programs is not recommended and can result in configuration files that are incompatible with SignalHawk ASL.

- Click on the Adv. Logging.
- Click on Reload/Update Config. option on the Adv. Logging — Database/Configuration Menu.

NOTE

If a database is currently attached, the Adv. Logging button will automatically enter the

Adv. Logging — Logging/Playback Menu, click the Back... button to enter the correct menu.

3. Select the appropriate csv file.
4. Do any of the following to edit the configuration file.
 - Add a span:
 - a. Enter settings
 - b. Click on Add New Span
 - Change a span:

Select the appropriate span in the Span Table.

Change the settings.

Click on Update Selected Span.

- Delete a span:

Select the appropriate span in the Span Table.

Click on Delete Selected Span.

Repeat Step 4 until all of the desired frequency spans have been entered.

Click the OK button to save the changes.

NOTE

- When you click on OK to save the new configuration file, you will be prompted to create a new database. A new database must be created whenever a new configuration file is created or when changes are made to an existing configuration file. You cannot log data obtained from two different configuration files into the same database.
- Default location for saved configuration files is My Documents > PC SignalHawk > ASL > My Configurations folder. Configuration files are saved as CSV files.

7. Create a new Database. See [Create a Database](#).

Create a Database

In order to collect data, an SQL Database must be attached to hold the collected data. For most applications, this will be achieved by creating a new database, but an existing database could also be attached, see [Attach an Existing Database](#).

1. Click on Adv. Logging.

NOTE

If a database is currently attached, the Adv. Logging button will automatically enter the

Adv. Logging — Logging/Playback Menu, click the Back... button to enter the correct menu.

2. Click on Create New Database.
3. Click on Yes in the popup window.
4. Select the configuration file being used for the database and Click on OK.

NOTE

Double clicking on the file will have the same result.

5. Enter the following:
 - Site Name (Used to archive the database)
 - Operator Name (used for reference)
6. Click the OK button to create the new database.

NOTE

Once the database is attached, the Adv. Logging — Logging/Playback Menu will be displayed.

7. Start logging data. See [Spectrum Trace Logging](#).

Attach an Existing Database

In order to collect data, an SQL Database must be attached to hold the collected data. For most applications, this will be achieved by creating a new database, but an existing database could also be attached.

1. Click on Adv. Logging.

NOTE

If a database is currently attached, the Adv. Logging button will automatically enter the Adv. Logging — Logging/Playback Menu, click the Back... button to enter the correct menu.

2. Click on Load Existing Database.
3. Click on Yes in the popup window.
4. Select the database configuration file name and click OK.
5. Select the Site Name and click OK.
6. Select the date (YYYYMMDD) and click OK.
7. Select the Timestamp (YYMMDDhhmmss) and click OK.
8. Select SignalHawkDB.mdf

NOTE

Selecting each item above actually navigates the file structure to locate the appropriate database file. All databases are saved with the same file name but they are all saved in date and time stamped folders.

9. Click the OK button to load the database.

NOTE

Once the database is attached, the Adv. Logging — Logging/Playback Menu will be displayed.

10. Perform one of the following:

- Start logging data. See [Spectrum Trace Logging](#).
- Playback Logged data. See [Spectrum Trace Playback](#)
- Search the database. See [Database Search](#).
- Recall and Display Saved Database Search . See [Recall Saved Database Search](#).

Spectrum Trace Logging

Once a configuration has been created and a database has been attached, data can be logged.

NOTE

There is a 10 gigabyte limit to individual databases. Once that limit is reached, the logging will continue without interruption and begin overwriting the oldest data in the database in 10,000 sweep segments (approximately 2 hours of trace data).

1. Click on Adv. Logging.
2. Click on Spectrum Trace Logging.
3. Click on Select Sweeps.

NOTE

The Select Sweeps Menu allows you to pick the sweeps that you would like to cycle through while recording data. The available sweeps are generated from the configuration file.

4. Select the appropriate data (spans and sweeps) for collection. See [Select Sweeps Dialog Box](#)
5. Click on OK.
6. Click on Start Config.

NOTE

This will initiate the series of sweeps selected in the previous step. You should see the device switching between various frequencies.

7. Click on Logging On/Off.
8. Enter Operator Name in the Site Information popup and click OK.
9. On should now be underlined to indicate data is being logged.

NOTE

When logging is activated, the words "Spectrum Analysis" in the upper left hand corner will have a red background.

Spectrum Trace Playback

Once data has been collected in a database, or an existing database has been attached, it is possible to playback the sweeps.

1. Click on Adv. Logging.
2. Click on Spectrum Trace Playback.
3. Click on Select Sweeps.

NOTE

The Select Sweeps Menu allows you to pick the sweeps that you would like to play back. For ease of use, playing back a single sweep is suggested.

4. Select the appropriate data for playback. See [Select Sweeps Dialog Box](#).
5. Click on OK.
6. Click Start Playback. See [Sweep Playback Menu](#).

Database Search

A database search may be used to quickly search the saved sweeps for signals that meet a set criteria.

1. Click on Adv. Logging.
2. Click on Spectrum Database Search.
3. Click on Select One Sweep.

NOTE

Only ONE sweep may be selected in the Sweep Name list during a database search.

4. Select the appropriate data for the database search. See [Select Sweeps Dialog Box](#).
5. Click on OK.
6. Click on Set Limit Lines. Set the criteria for the database search using limit lines or masks. See [Database Search - Limit Lines Menu](#).

NOTE

Custom Masks can be added to the Mask list. See [Creating Database Search Limit Masks](#).

7. Change Start Time and Stop Time, if desired.
8. Click on Start DB Search. The Search File Name Dialog Box will open.
9. Enter a File Name for the Database Search (or leave as default) and click OK.

NOTE

Individual Database searches may be recalled at a later time, see [Recall Saved Database Search](#).

10. Wait while the search is executed.
11. Once the search is complete the Database Recall dialog box will open with the search results.

NOTE

Each entry in the database recall window is a record within the database that matched the limits specified in the search criteria.

12. Click on any of the results in the Database Recall dialog box to display the Trace.

Database Recall Dialog Box

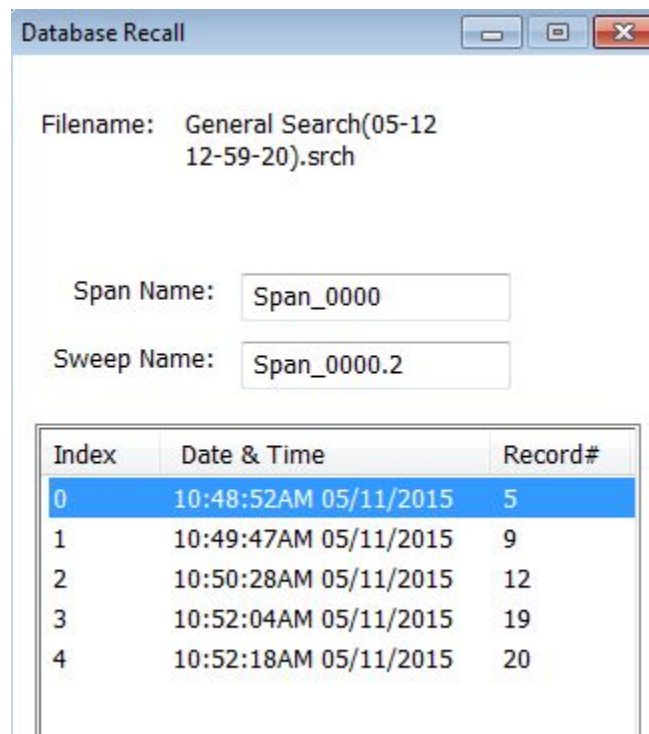

Recall Saved Database Search

1. Click on Adv. Logging.
2. Click on Database Search Recall.
3. Select the Saved database search file from the list and click OK.
4. The Database Recall dialog box will be displayed.
5. Click on any of the results in the [Database Recall dialog box](#) to display the Trace.

Measurements

Spectrum Analysis, measuring the power at each frequency in the sweep range, is the basic measurement. The other measurements interpret that data to provide useful results.

In the Spectrum Analyzer mode, the following measurements can be used:

- [Spectrum Analysis Measurement](#)
- [Occupied Bandwidth Measurement](#)
- [Channel Power Measurement](#)
- [Adjacent Channel Power Measurement](#)
- [Time Domain \(Zero Span\) Measurement](#)
- [Field Strength Measurement](#)
- [Demodulate Signal Measurement](#)
- [Carrier-to-Interference Ratio Measurement](#)
- [Out-of-Band and In-Band, Out-of-Channel Spurious](#)
- [Water Fall Spectrogram](#)

Spectrum Analysis Measurement

Spectrum Analysis measures the power at each frequency in the range shown on the screen.

1. From the Spectrum Analyzer list on the Start Menu.
2. Select Spectrum Analysis then press the Enter key.
3. Viewed spectrum can be updated using the [Freq & Span](#), [BW & Sweep](#), [Ampt & Trace](#), and [Mark & Limit](#) menus. Settings, traces, and screen images can be saved using the [File & Help Menu](#). Advanced Spectrum Logging and analysis can be accomplished using the [Adv. Logging menu](#).

Spectrum Analysis Screen

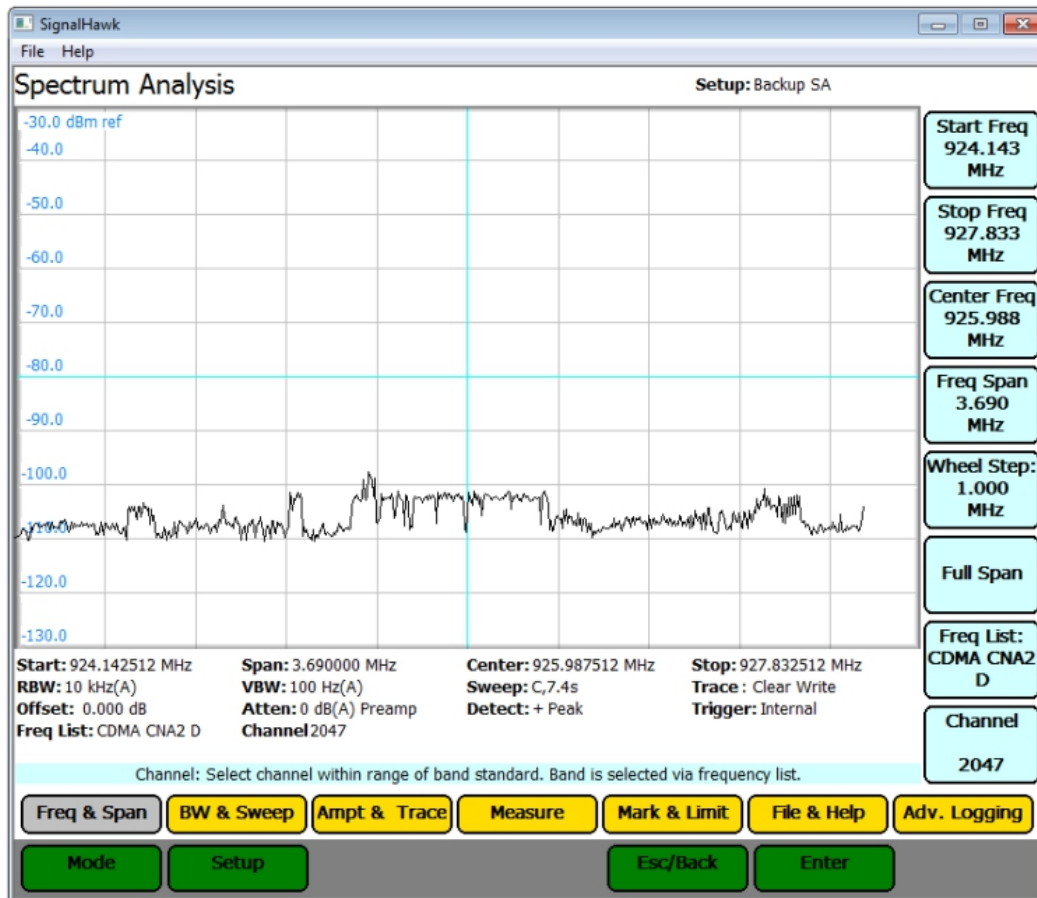

Occupied Bandwidth Measurement

Occupied Bandwidth measures the frequency band bandwidth that contains a specified percentage of the total power of the signal.

Occupied Bandwidth measurement gives best results with single-peaked signals. Bandwidth can be defined in two ways, % or dBc, both give measurement results in Hz units.

Threshold Modes

%

The calculated occupied bandwidth represents the user specified percent of the total power of the displayed span. Best for Watts power units.

dBc

The bandwidth is calculated by finding the frequencies above and below the center or carrier frequency that is the user specified dB below the carrier level. This method is best for measuring dBm power units.

Occupied Bandwidth Setup

For the best accuracy, set the center frequency so the main or carrier signal is centered on the screen before taking measurements.

The Occupied Bandwidth Measurement can be turned on using the [Start Menu](#) or the [Measure Menu](#).

1. Click on the Measure Menu button (5). See [Occupied Bandwidth Measurement Figure](#).
2. Click on Occupied BW: Menu Button.
3. If measurement is not already on, Click on Occupied BW: On/Off option (1) to turn on measurement.

NOTE

Underlined option is the active option.

4. Click on Threshold Mode option (2) to select either % or dBc.

5. Do one of the following:

- For % Threshold, click on the % option (3) and set the desired threshold using the mouse scroll wheel, arrow keys, or keyboard.
- For dBc Threshold, click on the dBc option (4) and set the desired threshold using the mouse scroll wheel, arrow keys, or keyboard.

Measured bandwidth will be displayed in the measurement settings area (6) at the bottom of the display. Markers 1 and 2 will be turned on at start and stop of the Occupied BW Measurement.

Occupied Bandwidth Measurement



Channel Power Measurement

Channel Power measures the Integration Bandwidth, the total power over a frequency range, concentrated on the center frequency of the sweep. It is useful for channelized (frequency-division multiplexed) signals. Results are shown in both total power in the channel (in dBm or Watts), and spectral density (dBm or Watts per Hz).

Channel Power Setup

For best accuracy, set the center frequency so the signal is roughly centered before taking measurements. In addition, the span should be 1.5 to 5 times as large as the desired channel width.

The Channel Power Measurement can be turned on using the [Start Menu](#) or the [Measure Menu](#).

1. Click on the Measure Menu button (3). See [Channel Power Measurement Figure](#).
2. Click on Channel Power: Menu Button.
3. If measurement is not already on, Click on Channel Power: On/Off option (1) to turn on measurement.

NOTE

Underlined option is the active option.

4. Select the Integration Bandwidth (IBW) option (2).

NOTE

If a channelized band is selected from the Frequency list, this parameter is automatically set.

5. Set the desired IBW using the mouse scroll wheel, arrow keys, or keyboard. The default unit is MHz.

NOTE

Use the keyboard to change the IBW if the unit of measure must be changed.

6. Channel power and power density will be displayed in the measurement settings area (4) at the bottom of the display. Markers 1 and 2 will be turned on at start and stop of at the band edges.

Channel Power Measurement

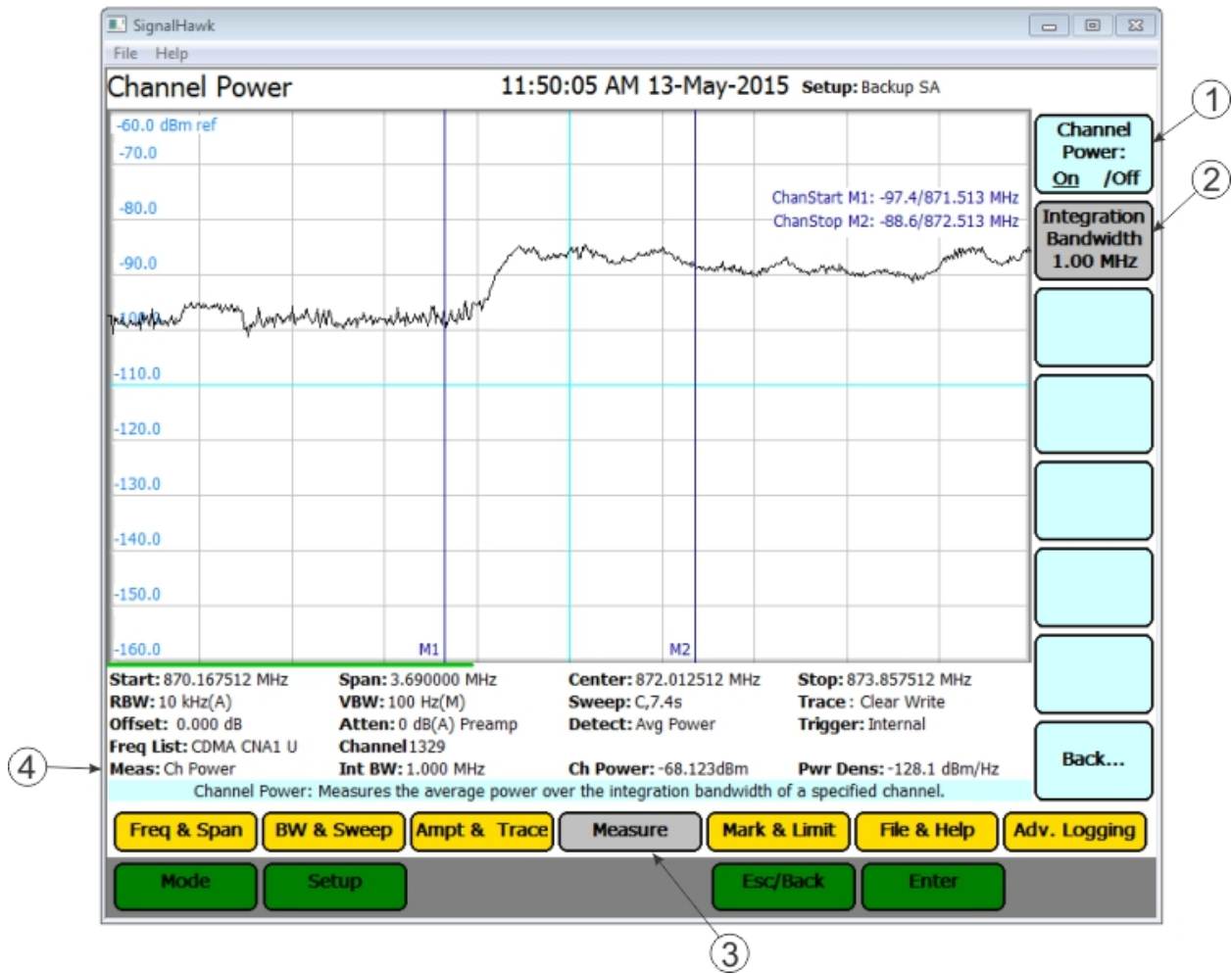

Adjacent Channel Power Measurement

Adjacent Channel Power measures the relative power of frequency bands adjacent to a central channel. This is often used to identify power leakage from the center channel into the adjacent channels. The total power in the central (main) channel is displayed in dBm (Ch Power), and the power in the adjacent channels is displayed as dB below and above the main channel power (Dn ACPR and Up ACPR).

Adjacent Channel Power Setup

For best accuracy, set the central frequency so the signal is centered before taking measurements. In addition, set the span so the central, upper, and lower channels are all shown on the screen.

The Channel Power Measurement can be turned on using the [Start Menu](#) or the [Measure Menu](#).

1. Click on the Measure Menu button (5). See [Adjacent Channel Power Measurement Figure](#).
2. Click on ACPR: Menu Button.
3. If measurement is not already on, Click on ACPR: On/Off option (1) to turn on measurement.

NOTE

Underlined option is the active option.

NOTE

If a channelized band is selected from the Frequency list, the following parameters are automatically set.

4. Click Channel Width option (2) to set the width of the central channel using the mouse scroll wheel, arrow keys, or keyboard.

NOTE

The central channel can be set to a different frequency width than the adjacent channels, but both adjacent channels have the same width.

5. Click Adj Chnl BW option (3) to set the width of the adjacent channels using the mouse scroll wheel, arrow keys, or keyboard.
6. Click Channel Separation option (4) to set the Center-to-Center channel separation using the mouse scroll wheel, arrow keys, or keyboard.

NOTE

Channel separation is the distance from the central channel's center frequency to the

adjacent channel's center frequency. If there is no guardband between channels, the channel spacing should be half (channel width + adjacent channel width).

- Channel power, Up ACPR, and Dn ACPR will be displayed in the measurement settings area (6) at the bottom of the display. All 6 markers will be used to show the edges of the central, upper, and lower channels. Markers 1 and 2 will mark the start and stop of the central channel. Markers 3 and 4 will mark the start and stop of the lower channel (Dn ACPR). Markers 5 and 6 will mark the start and stop of the upper channel (Up ACPR).

Adjacent Channel Power Measurement

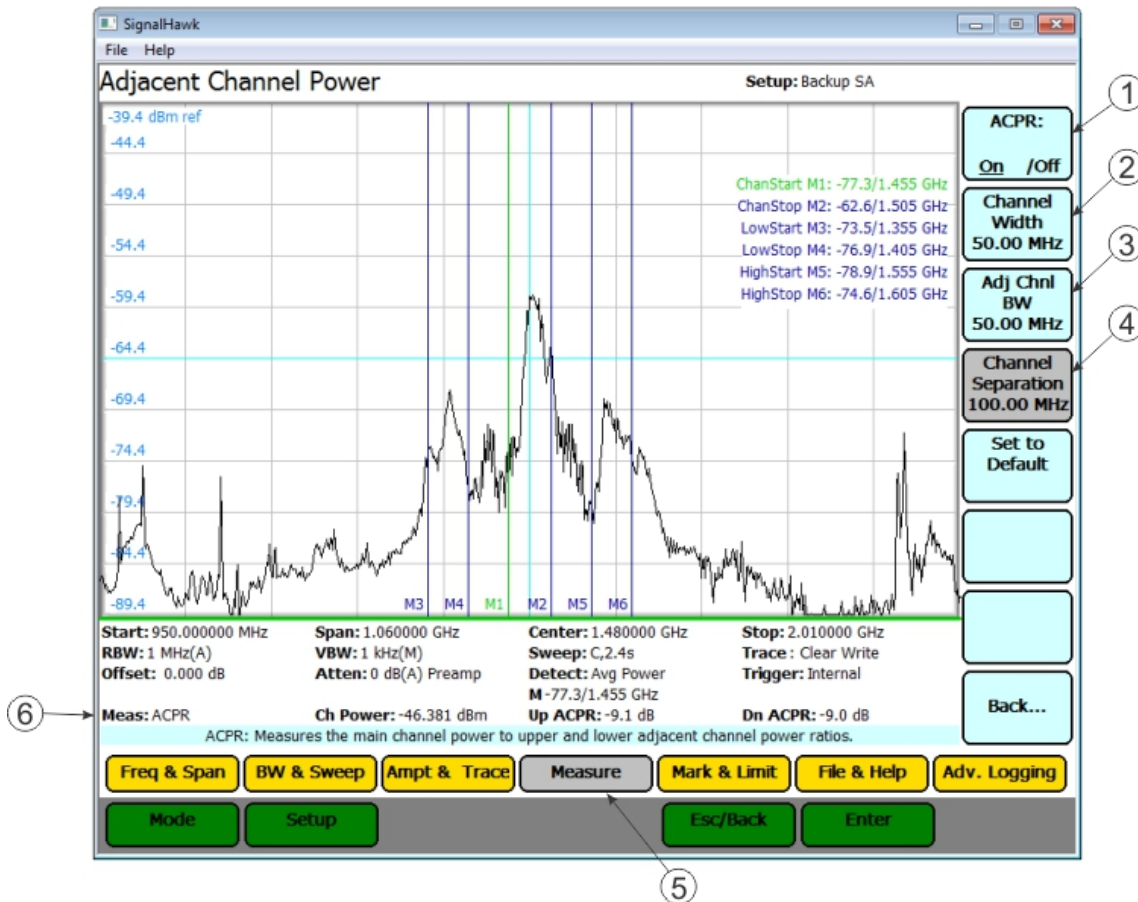

Time Domain (Zero Span) Measurement

In Time Domain, the amplitude of a single frequency is measured, rather than sweeping a range of frequencies. The SignalHawk measures and displays the amplitude of the frequency for a specified period (sweep time) and refreshes during the next sweep. The Time Domain trace resembles the horizontal line display on an oscilloscope.

Time Domain (Zero Span) Setup

NOTE

The center frequency is being measured.

The Time Domain Measurement can be turned on using the [Start Menu](#) or the [Measure Menu](#).

1. Click on the Measure Menu button (3). See [Time Domain Measurement Figure](#).
2. Click on Time Domain: Menu Button.
3. If measurement is not already on, Click on Time Domain: On/Off option (1) to turn on measurement.

NOTE

Underlined option is the active option.

4. Press the Sweep Time option (2) and set the single sweep time using the mouse scroll wheel, arrow keys, or keyboard.

NOTE

- Time range can be set from 1 ms to 100 s.
- There are a limited number of pixels, so longer sweep times mean less detail in the display.
- This enables the Video Trigger in the BW & Sweep menu. To use the Video Trigger, see video trigger options on the [Trigger Source Menu](#).

Time Domain Measurement

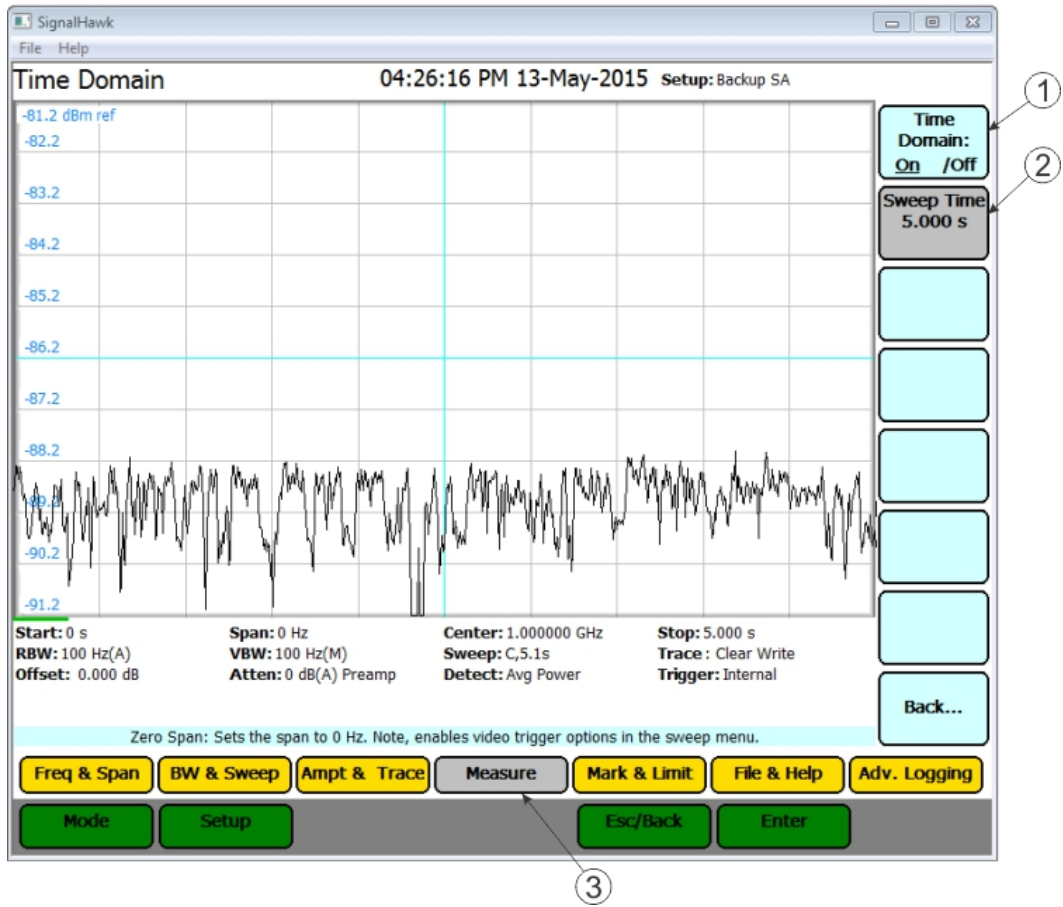

Field Strength Measurement

Field Strength measures the signals reaching an antenna. The SignalHawk automatically corrects the sweep data for the antenna's gain and frequency dependence and displays it in dBm / m.

Field Strength measurement Setup

The Field Strength Measurement can be turned on using the [Start Menu](#) or the [Measure Menu](#).

1. Connect an antenna to the RF In connector on the SignalHawk.

NOTE

Use an antenna with known gain characteristics. For best accuracy, set the start and stop frequencies to the measurement range of the chosen antenna.

2. Click on the Measure Menu button (3). See [Field Strength Measurement Figure](#).
3. Click on Field Strength: Menu Button.
4. If measurement is not already on, Click on Field Strength: On/Off option (1) to turn on measurement.

NOTE

Underlined option is the active option.

5. Click Antenna option (2) and select the antenna type from the drop down list.

NOTE

The antenna type, valid frequency range, and gain in dB (relative to an isotropic radiator) are shown in the measurement settings area.

6. Measure the strength of the signal emanating from a transmission antenna (within the frequency range of the antenna connected to the RF In port).
7. Move to various positions relative to the transmitting source and observe the signal value.

Field Strength Measurement

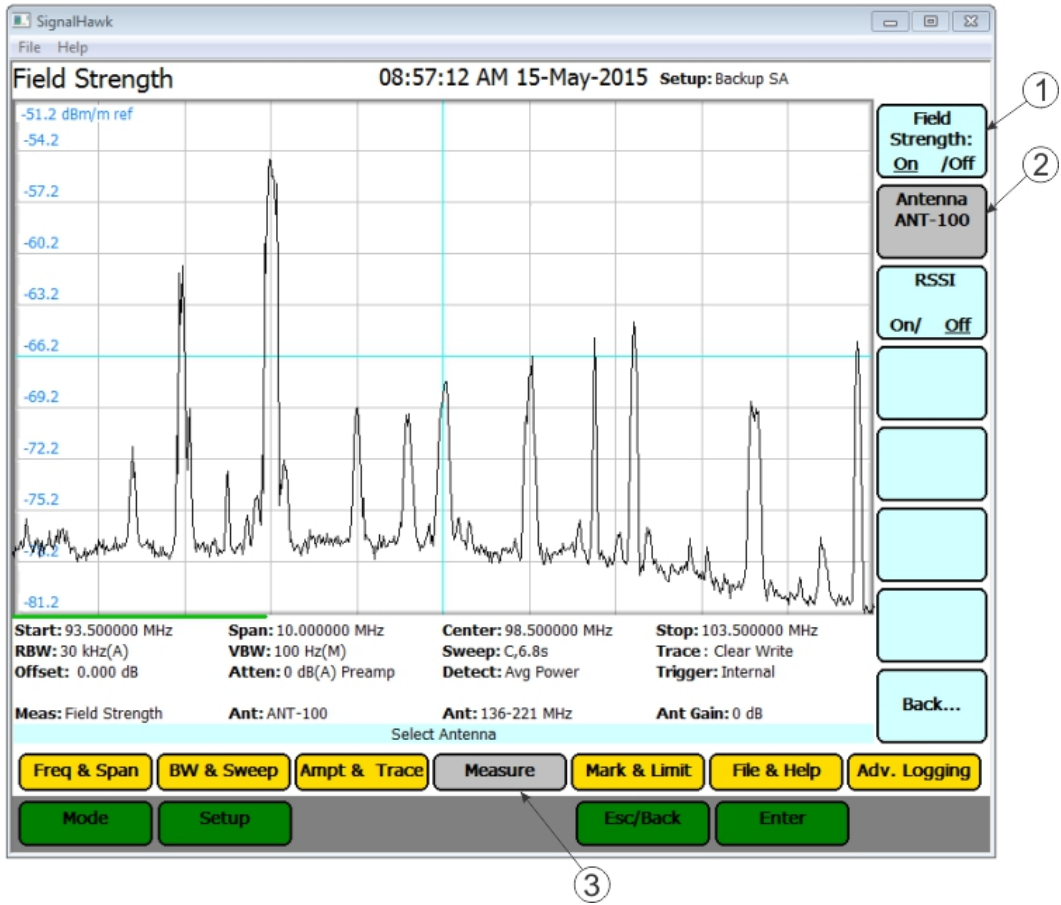

Received Signal Strength Indicator (RSSI)

RSSI provides an audible indication at the frequency of the current marker. It will beep faster as the received signal strength goes up and slows as it goes down.

Similar to Water Fall, power is linearly mapped to a range of 0-210 using the same range as for the Water Fall for simplicity. The beep rate and volume are proportional to the mapped power value at the current marker index. Values of zero are equivalent to continuous beeps and -210 are equivalent to a beep every 4 seconds.

RSSI Setup

1. Click on RSSI option (1). See [Field Signal Strength Measurement with RSSI Figure](#).
 2. To move Marker do one of the following:
 - Use mouse scroll wheel, arrow keys, or keyboard to set marker position.
 - Click on Marker to Max Peak option (2) to move marker to the peak signal.
- Click on Volume option (3), set volume to desired level.

Field Signal Strength Measurement with RSSI

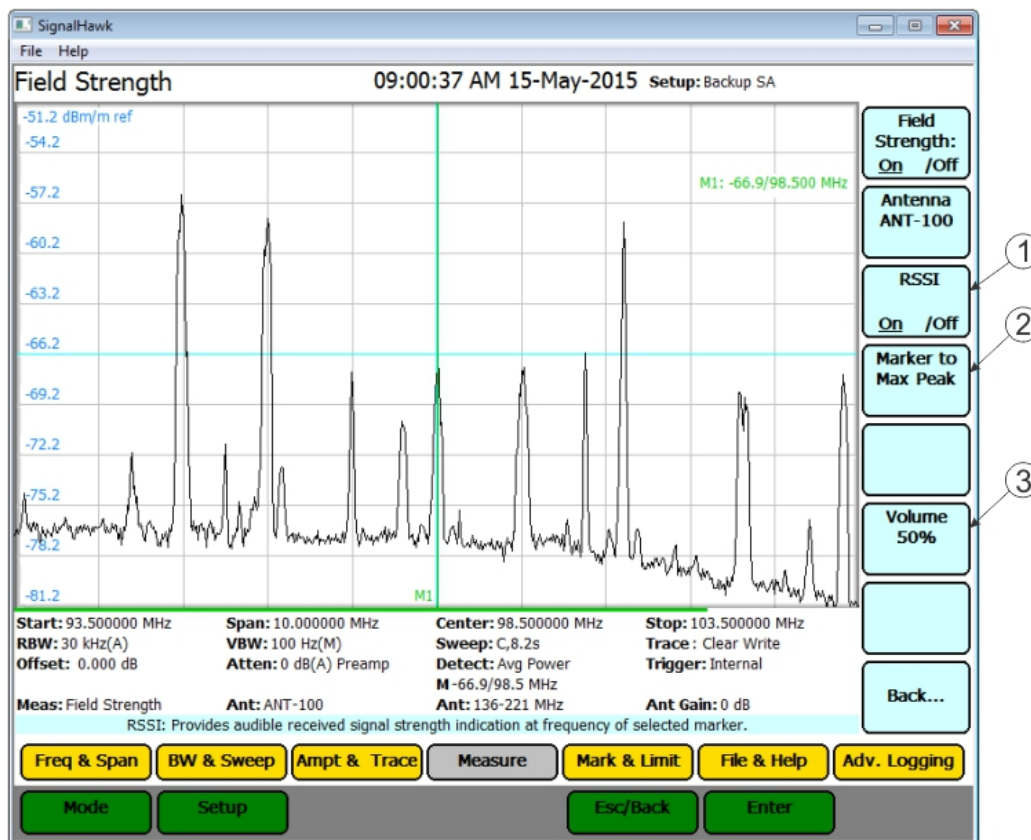

Demodulate Signal Measurement

Removes the carrier and sends the signal to the internal speaker or headphones. The SignalHawk can demodulate AM, narrowband FM, and wideband FM signals. It can also set the specific frequency and volume.

The Demodulate Signal Measurement can be turned on using the [Start Menu](#) or the [Measure Menu](#).

1. Click on the Measure Menu button (6). See [Demodulate Signal Measurement Figure](#).
2. Click on AM/FM Demod: Menu Button.
3. If measurement is not already on, Click on AM/FM Demod: On/Off option (1) to turn on measurement.

NOTE

Underlined option is the active option.

4. Click Demod type option (2), then click on desired demodulation option.
 - AM
 - FM Wideband
 - FM Narrowband

Click the Demod Freq option (3) then do one of the following to set the demodulation frequency:

- Use mouse scroll wheel, arrow keys, or keyboard to set demodulation frequency.
- Click on Demod Freq to Marker option (4) to set demodulation frequency to active marker position.

Click the Demod Time option (5) to set the time to demodulate the signal:

Use mouse scroll wheel, arrow keys, or keyboard to set demodulation time. Range is 1 to 500 Seconds.

- Allow audio to play for the demodulate time.
- Repeat as necessary.

Demodulate Signal Measurement

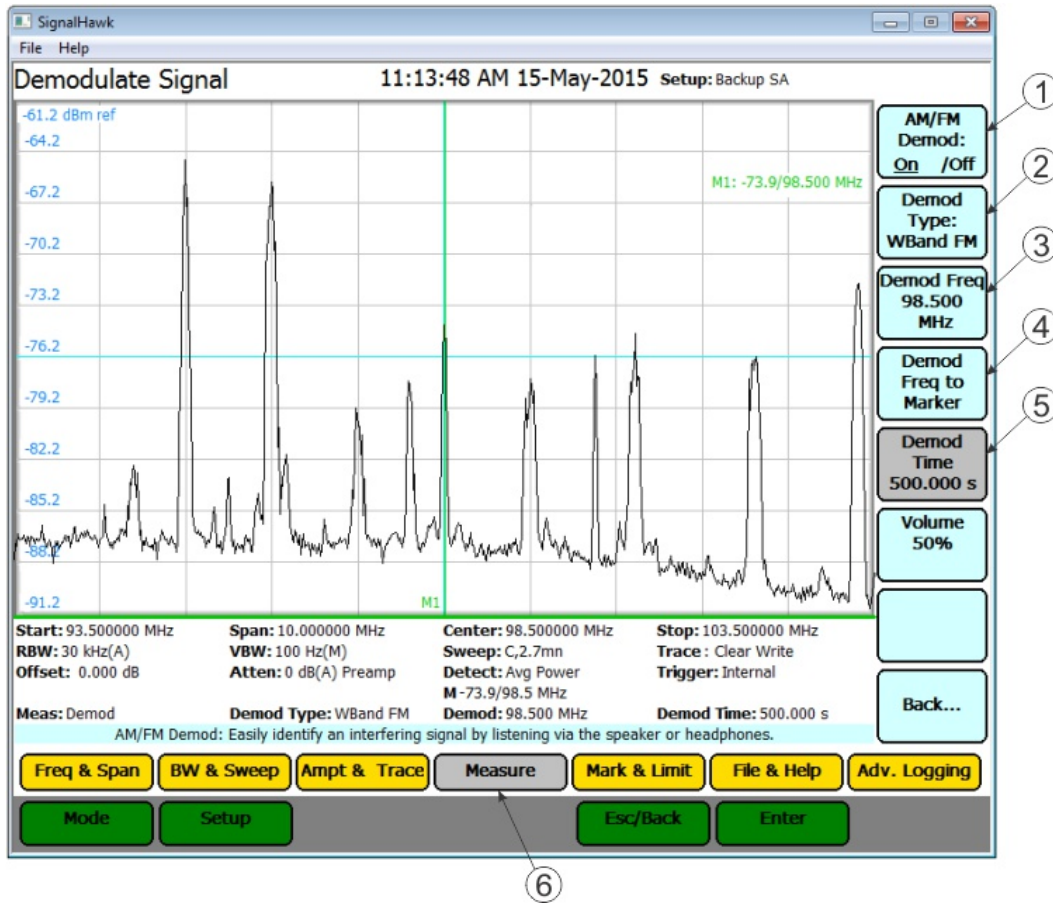

Carrier-to-Interference Ratio Measurement

Calculates the ratio of the carrier signal power to the power level of the noise and interference signals.

To determine the ratio, two measurements need be done. First sweep should be the carrier and interferer. The second sweep should be the interferer alone.

Carrier-to-Interference Ratio Setup

NOTE

Because the transmitted carrier must be turned off for the second portion of this measurement, access to the transmitter is needed to complete this procedure.

The Carrier-to-Interference Ratio Measurement can be turned on using the [Start Menu](#) or the [Measure Menu](#).

1. Click on the Measure Menu button (5). See [Carrier-to-Interference Ratio Measurement Carrier ON Figure](#).
2. Click on C/I: Menu Button.
3. If measurement is not already on, Click on C/I: On/Off option (1) to turn on measurement.

NOTE

Underlined option is the active option.

4. Move the marker to the frequency to measure. Do one of the following:
 - Use mouse scroll wheel or keyboard arrow keys to move marker to the desired frequency.
 - Select Marker to Max Peak to quickly identify the signal to be measured.
5. Click on Measure Carrier option (3) to measure the carrier signal. The Carrier measurement (6) will be displayed in the measurement area at the bottom of the screen.
6. Turn off the carrier transmitter.
7. Click on Measure Interference option (4) to measure in interference signal level. See [Carrier-to-Interference Ratio Measurement Carrier OFF Figure](#).
8. The Carrier measurement (7) will be displayed in the measurement area at the bottom of the screen.

NOTE

The carrier power and interferer power will be displayed in selected power units, and the ratio in dB.

Carrier-to-Interference Ratio - Carrier On

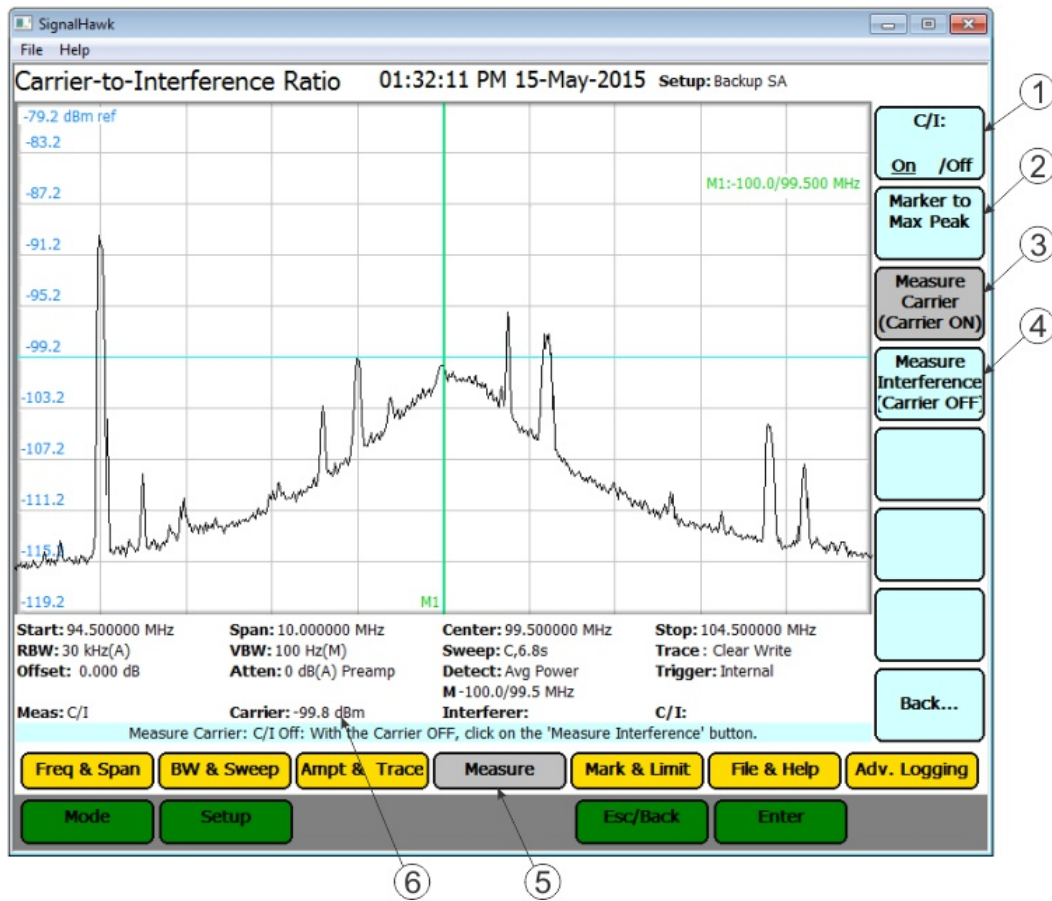

Carrier-to-Interference Ratio - Carrier Off

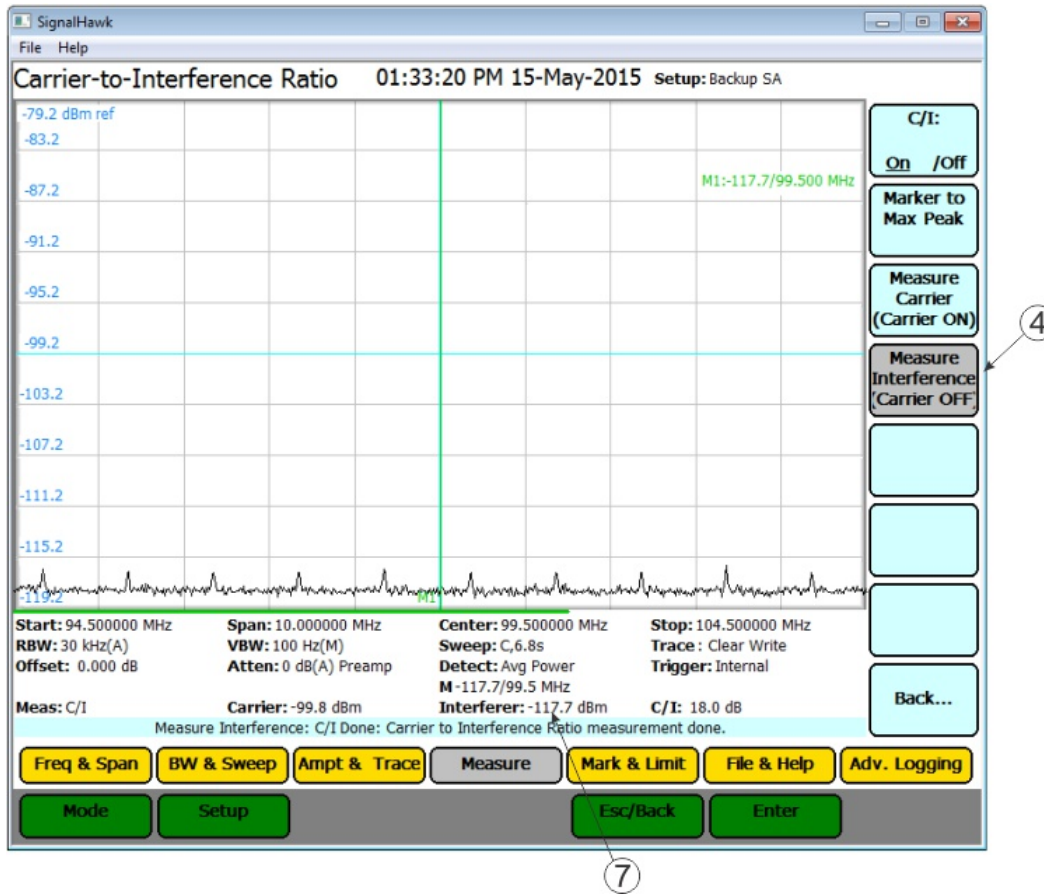

Out-of-Band and In-Band, Out-of-Channel Spurious

NOTE

These are not automated measurement methods and are not listed on the measure menu.

Out-of-Band & In-Band, Out-of-Channel Spurious measures the distortion and interference inside or outside a system band.

1. Click on Mark & Limit.
2. Click on the Select Marker: 1 2 3 4 5 6 option to select marker 1.

NOTE

The bracketed number indicates the active marker.

3. Click on Marker: On/Off to turn on marker.
4. Use the arrow keys, the number keys or mouse scroll wheel to move the marker over one of the spurs.
5. Compare the value of the marker to the specified allowable level of Out-of-Band (In-Band, Out-of-Channel) spurious emissions for the corresponding channel transmit frequency.

Utilities

With SignalHawk's built-in utilities, information about the instrument is displayed. The Menu keys provide information about the software, hardware, and data files. Utilities can be accessed by clicking on Utilities from the Start Menu screen, or by clicking on File & Help from a measurement screen then click on Utility. To exit the Utility mode, press the Esc/Back function key to return to the previous screen, or press the Mode key to go to the Start Menu screen.

Utility Menu

Click on Utility to go to the Utility Menu. When the utility menu is accessed, new menu keys and selections for getting help and exiting to the Windows operating system are activated. The Utility Menu screen displays status information about the instrument and about the operating system.

Utility Menu

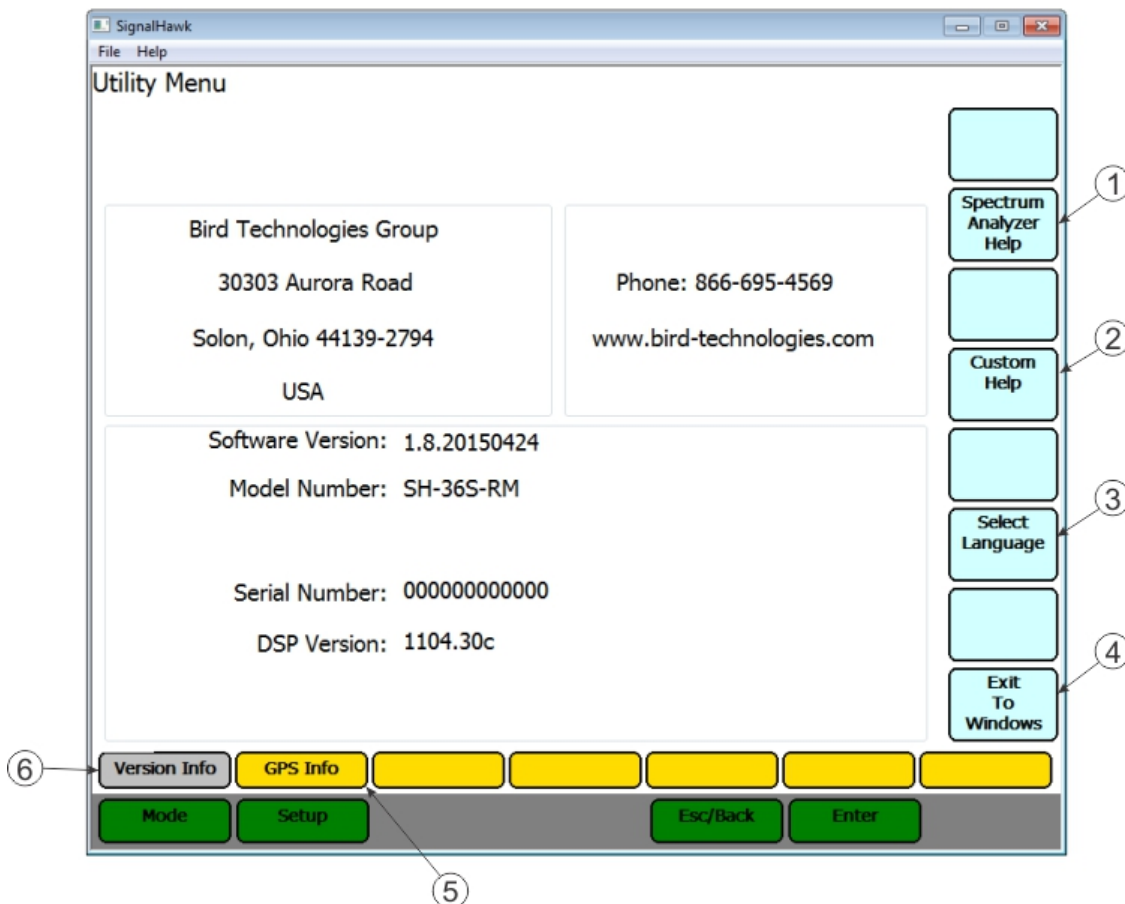

| Item | Name | Description |
|------|------------------------|--|
| 1 | Spectrum Analyzer Help | When pressed, displays the SignalHawk Start-up Instructions. Press the up- and down-arrow keys or use the mouse scroll wheel to scroll through the displayed text. Click on Close Help Display or Esc to return to the Utility Menu. |
| 2 | Custom Help | When pressed, displays the contents of the custom help file. The custom help file may be modified to display user specific information. See Modify custom help. |
| 3 | Select Language | When pressed displays a selection list of available languages. |
| 4 | Exit to Windows | When pressed, exits the SignalHawk program. |
| 5 | GPS Info | When pressed, displays GPS location data, the currently acquired satellites and their signal levels. This menu also provides settings for formatting GPS information. |
| 6 | Version Info | When clicked, displays SignalHawk software version, model number, serial number, and contact information for Bird Technologies Group. |

Customizing SignalHawk Content

There are lists used to aid the user in quickly setting up some SignalHawk functions and measurements. These lists can be updated to include additional settings important to the user. The following lists can be customized using this procedure.

NOTE

Adding information to the four lists mentioned in this procedure is accomplished using a text editor. Bird Limit Masks application cannot be used to edit these lists.

- Antenna Type Settings used in [Field Strength Measurement](#).
- Band Type Settings (Frequency List) on the [Freq & Span Menu](#).
- Limit Mask Type Settings on the [Mark & Limit Menu](#).

NOTE

Database search limit masks are created using the Bird Limit Masks application. See [Creating Database Search Limit Masks](#).

- Cable Type Settings. (Not Used on this model)
1. Exit SignalHawk program.
 - a. Go to the Utilities menu.
 - b. Click Exit to Windows menu option.

NOTE

The SignalHawk will ask for verification.

2. Go to My Computer on the PC.
3. Click on the following :
Local Disk (C:Drive) > ProgramData >PC SignalHawk >My Lists

NOTE

ProgramData folder is a hidden folder, if the folder is not visible open window tools menu (Tools>Folder Options>View) and select "Show hidden files, folders and drives."

PC SignalHawk Directory

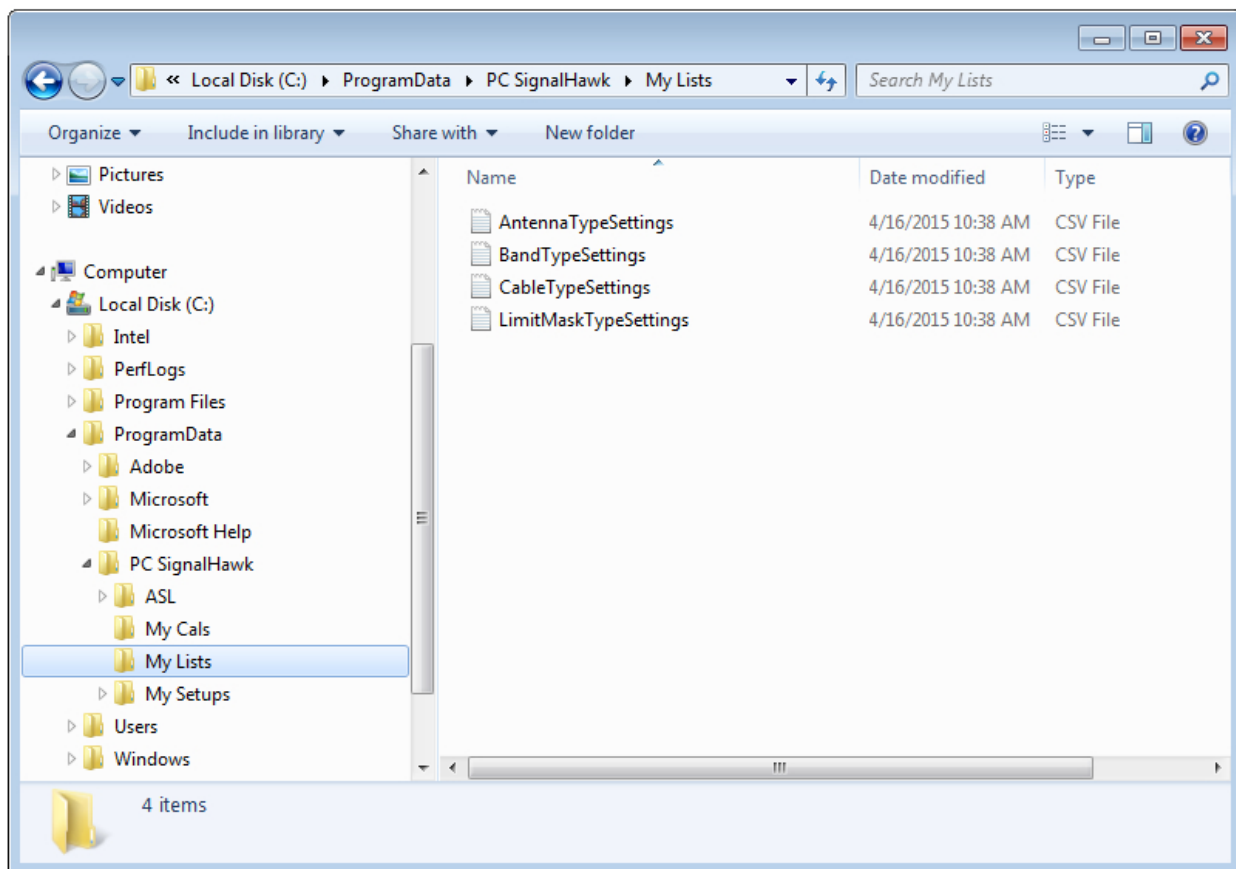

4. Copy the csv file of the list to be edited to the desktop of the PC.

NOTE

It is recommended that a copy of the original list be saved using a different name for use in the event errors are made during editing.

5. Open the csv file.
6. Add custom information into the list.
7. Copy the csv file back into the My Lists directory.

NOTE

The computer will ask for verification to overwrite the file in the directory.

8. Close the My Lists directory window.
9. Launch the PC SignalHawk program.

Creating Database Search Limit Masks.

Limit masks are used during [database searches](#) to set criteria for the search. Limit masks can be created using this procedure. Each mask created will be saved as an individual CSV file (one limit mask per file). If more than one limit mask is required, several CSV files must be made. Once the limit masks are created they can be selected during a database search on the [Database Search - Limit Lines Menu](#).

1. Double click the Launch LimitMasks icon.

NOTE

If the icon is not on the desktop navigate to Local Disk (C:Drive) > Program Files > Bird Technologies Group > PC SignalHawk > System > LimitMasks

2. Click the Create New Mask button (1) on the Limit Masks dialog box. See [Limit Masks Dialog Box](#).

Limit Masks Dialog Box

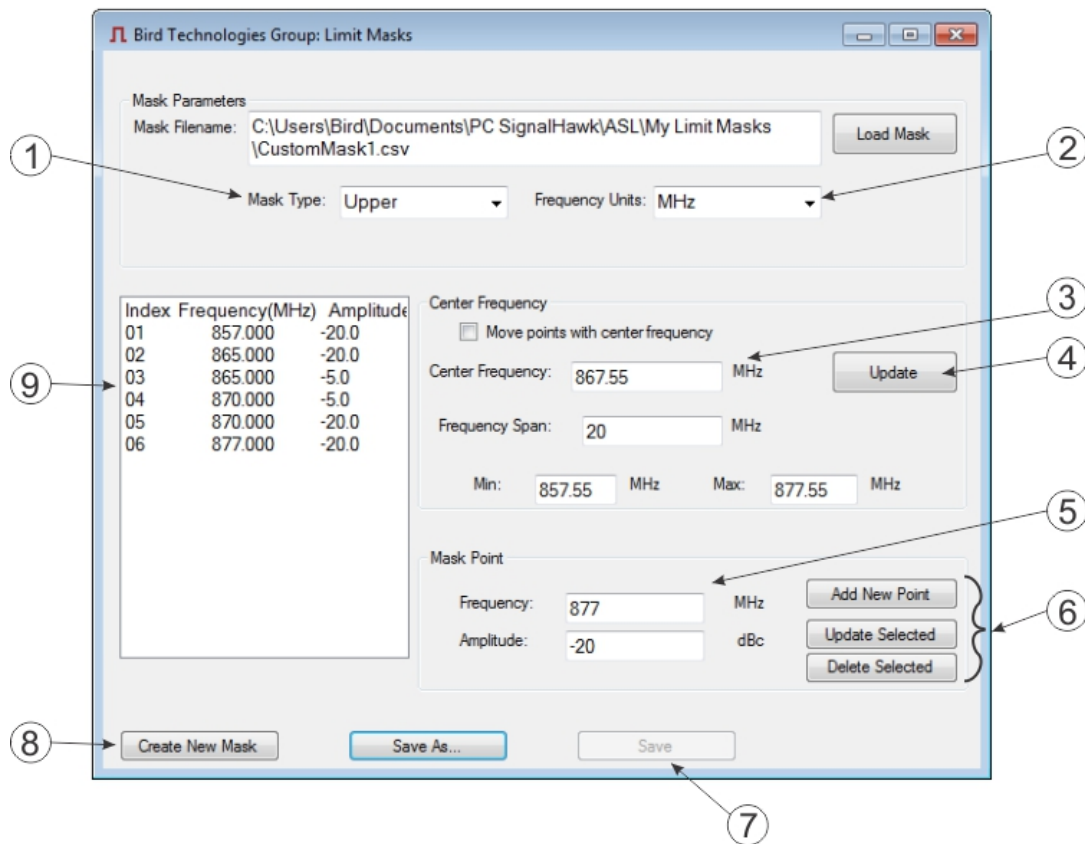

3. Type a File name for the Limit Mask File in the Save As dialog box. See [Save As Dialog Box](#).

NOTE

- The name of the file is also the name that will appear in the limit mask selection list.
- It is recommended that all database search limit masks be saved in the default file location: Documents\PC SignalHawk\ASL\My Limit Masks

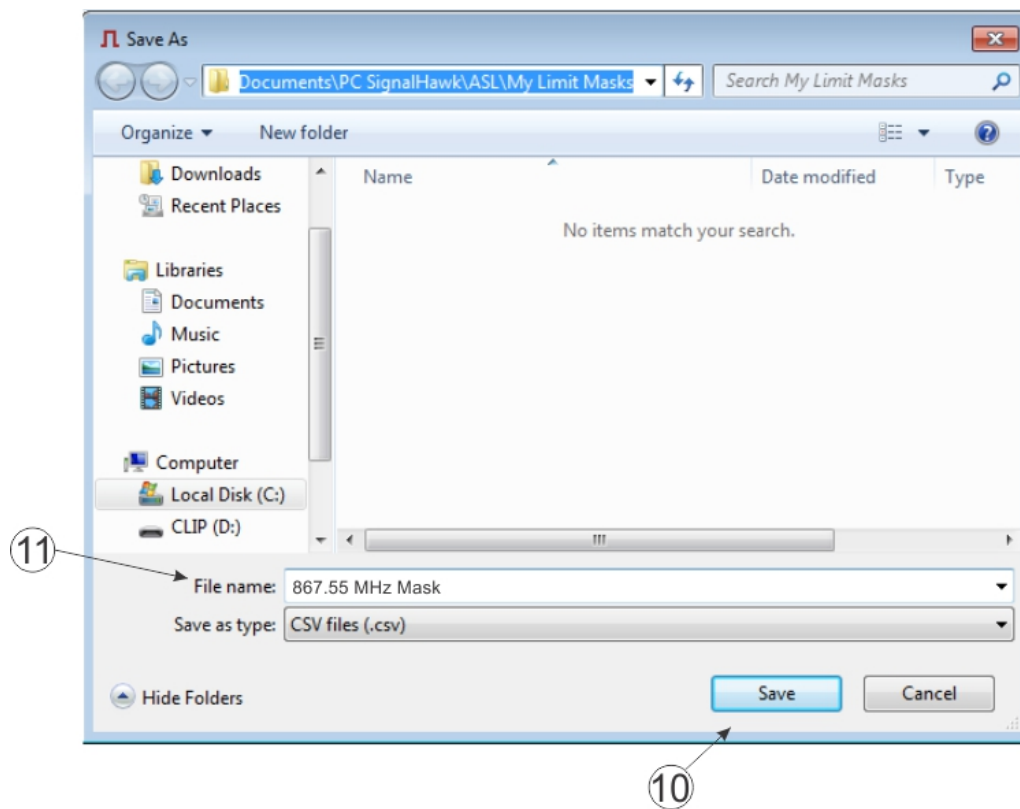
Save As Dialog Box

4. Click Save
5. Select upper or lower limit mask for Mask Type (1). See [Limit Masks Dialog Box](#).
6. Select Frequency Units (2).
7. Enter the center frequency and Frequency Span (3), then click Update (4).

NOTE

The Min and Max frequency will automatically fill in after the Update button is pressed.

- Add mask points by entering frequency and amplitude (5) of each point then clicking Add New Point (6).

NOTE

- The mask points (9) in the [Limit Masks Dialog Box](#) will create a mask on the SignalHawk similar to what is shown in the figure below [Mask Output](#).
- Any mask point can be changed by selecting the mask point in the list (9) updating the frequency and amplitude (5) and clicking Update Selected (6).

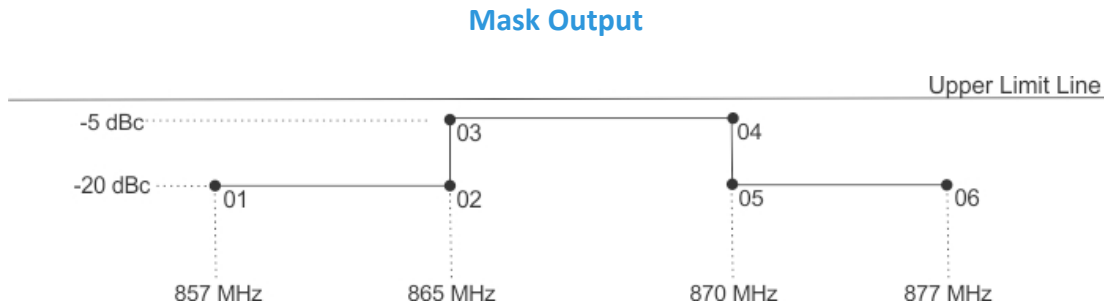

- Repeat step 8 until all points have been entered, then click Save (7).
- If additional masks are desired, repeat step 2 through 9 to create additional limit masks.
- Close the [Limit Masks Dialog Box](#).

ASL Report Generator

The ASL Report Generator will export a spreadsheet of a single span from the database currently attached on the SignalHawk via the [Adv. Logging — Database Configuration Menu](#).

The Data will be saved in the spreadsheet in the following format:

| TimeStamp | Minimum | Average | Maximum |
|------------------------|------------|------------|------------|
| MM/DD/YYYY hh:mm:ss AM | xxx.xxxxxx | xxx.xxxxxx | xxx.xxxxxx |

The ASL Report Generator can also produce a graph of the data included in the report. If graphical output is selected, the result is two sheets with the report file, one sheet containing the data and a second sheet containing the graph (chart).

NOTE

SignalHawk must be running with the database attached containing the desired data to generate an ASL report.

- Double click the ASL Report Generator icon.
- Click Connect to DB... (1) on the [BTG ASL Report Generator Dialog Box](#).

BTG ASL Report Generator Dialog Box

BTG ASL Report Generator v1.1.2.0

SQL Express Servers: SH36S-RM Limit Servers to this PC

Select Sweep

Span Type: Span 0

Sweep Name: Span_0000.1

Connect to DB...

Sweep Information

Start Frequency (MHz): 861.675

Stop Frequency (MHz): 873.425

First Time (s): 1431113845 05/08/2015 19:37:25

Time Span (s): 242103

Report Information

Freq of Interest (MHz): 867.55

Start Time (s): 0

Time Span (s): 242103

Time Interval (s): 1

Content

Include Minimum

Include Average

Include Maximum

Include Graphs

3. Select the Span Type (2).
4. Select the desired Sweep (3).
5. Select the content for the report using the check boxes (4) in the Report Information section.
6. Click Generate Report (5).
7. Enter a File name for the report in the [ASL Report — Save As Dialog Box](#).

ASL Report — Save As Dialog Box

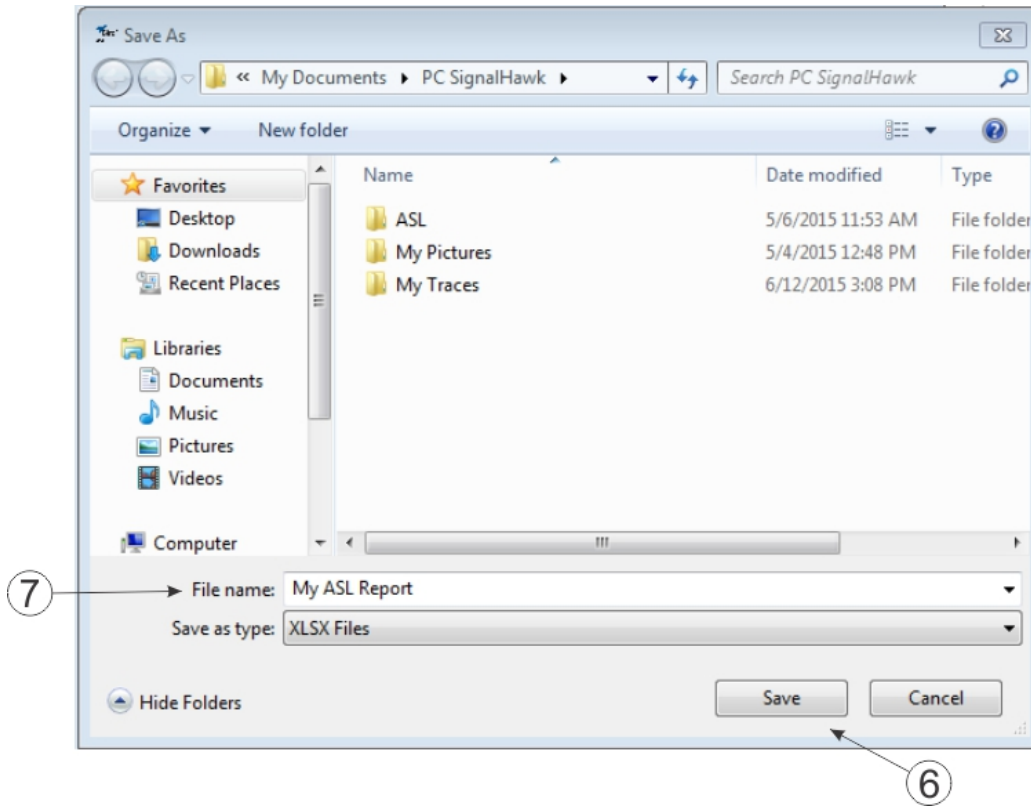

8. Verify the report has been generated.

NOTE

A green status bar on the [BTG ASL Report Generator Dialog Box](#) will indicate the status of the report, once the status bar is completely green the report is complete.

9. If desired, repeat steps 3 through 8 to generate additional reports.
10. Close the [BTG ASL Report Generator Dialog Box](#) when complete.

PC Tool

Bird's SignalHawk PCTool enables individual analysis. One or more saved traces can be opened and compared. They can also be copied and pasted into other open files, as well as adding markers or limit lines. In addition, labels can be added and modifications saved to files.

Downloading and Installing Software

These files are on the CD supplied with the SignalHawk, and can also be downloaded from the Bird Technologies website.

www.birdrf.com

Installing the PC Tool Software

1. Access Bird Website page for appropriate SignalHawk.
2. Scroll to DOWNLOADS: and click on PC Tool Interface.
3. Click on "Install SH-36S-PC Tool Software."
4. Save the compressed file to the PC's desktop.
5. Double click the compressed file on the PC desktop.
6. Click-and-drag the SHPCTool icon (Setup file) out of the compressed file window and onto the PC desktop.
7. Double-click the Setup file.
8. Follow the instructions in the Install Wizard to complete the installation.

Menu Bar

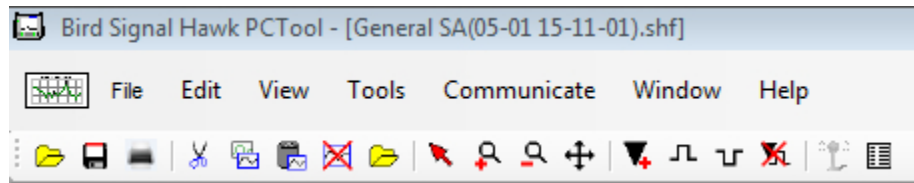

File

Presents commands to Open, Close, Save, Export, and Print SignalHawk files that are stored on the PC.

Note: By default, traces will be saved to the "My Traces", which is a sub-folder under the folder where the PCTool was installed.

Edit

Presents commands to copy the active trace from a graph and paste it into another graph. Traces can also be deleted from a graph.

NOTE

The last trace remaining on a graph cannot be removed.

View

Presents commands to manipulate the trace - Zoom In, Zoom Out, Add, and Delete Markers or Limit Lines, Autoscale the Trace, Set to Normal Mode, and Set Options. Normal mode is identified by the standard Windows "selection" cursor (arrow pointing to the upper left). DTF Settings (Cable Vp & Loss, Start & Stop Distance, etc) can also be viewed.

Tools

Presents access to the units converter.

Measurements

NOTE

This option not applicable to PC or Rack Mount SignalHawks.

Presents the various measurement types to display the reading. The types of measurement depend on the type of trace file being read. VNA files will give Match Measurement, Distance-to-Fault, Cable Loss, and Smith Chart as options.

Communicate

NOTE

This option not applicable to PC or Rack Mount SignalHawks.

Presents commands to get files from and/or send files to the SignalHawk. In addition, use this function to upgrade the SignalHawk software/firmware.

Tool Bar

Tool bar icons are shortcuts for the tasks available on the Menu bar.

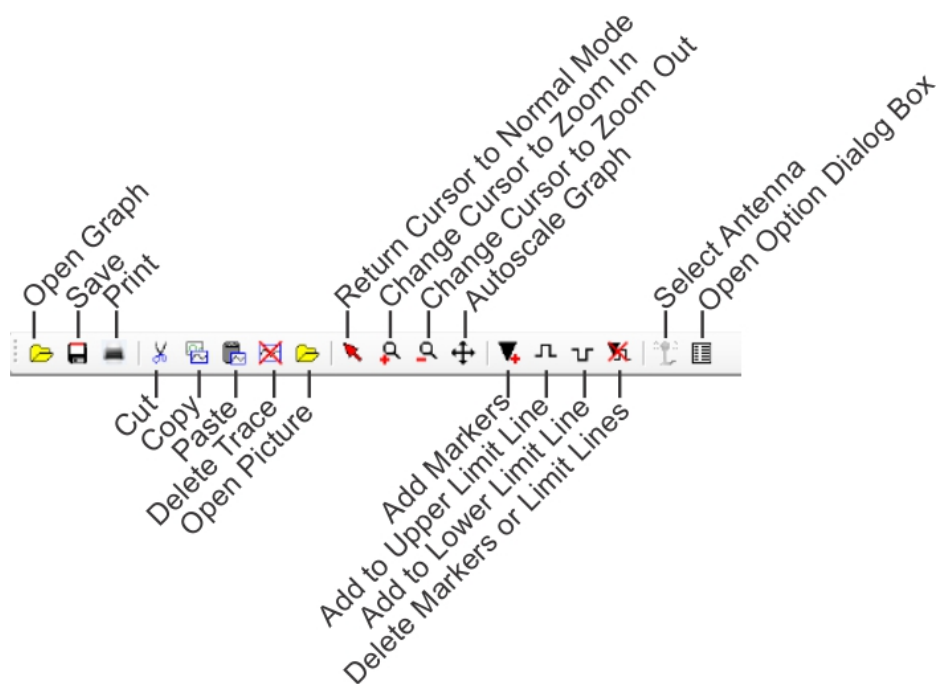

Open Graph

Opens a graph.

Save

Saves a copy of a graph.

Print

Prints a graph.

Cut

Cuts a trace from a graph.

Copy

Copies a trace from a graph.

Paste

Pastes a trace onto a graph.

NOTE

A trace from one measurement type cannot be placed onto a graph from another measurement type (Occupied Bandwidth, Channel Power, etc). The graphs do not match.

Delete Trace

Deletes a trace from a graph.

NOTE

The last trace remaining on a graph cannot be removed.

Open Picture

Opens trace saved as picture (bmp,jpg, etc..)

Return to Normal Mode

Returns the cursor back to an arrow from Zoom In, Zoom out, Marker, and Limit Line function.

Zoom In

Changes the cursor to a Zoom In function when left mouse button is clicked.

Zoom Out

Changes the cursor to a Zoom Out function when left mouse button is clicked.

Autoscale Graph

Resizes the axis to fit all traces on the graph.

Add Markers

Drops a marker onto a graph.

Add to Upper Limit Line

Adds a limit line to the graph.

- First click will create a point on the graph with a highlighted line.
- Second click will create another point that connects to the first point via a line.
- Third click connects to the second, and so on.

Add to Lower Limit Line

Adds a limit line to the graph.

- First click will create a point on the graph with a line.
- Second click will create another point that connects to the first point via a line.
- Third click connects to the second, and so on

Delete Markers or Limit Lines

Deletes a marker, a limit line, or a point on a limit line. When deleting points, the icon will change to an eraser graphic when the icon floats over something that can be deleted.

Option Dialog Box

Opens the pop-up Option Dialog box. See [Options Dialog Box](#).

Measurement Types

The measurement types for that file are displayed, depending on the type of file being read.

Options Dialog Box (View>Options)

The Options dialog box contains six tabs - Scale, Units, Markers, Limits1, Limits 2, and Labels. Select a tab and enter or edit specific values for the currently active graph.

Scale Tab

- Allows manual entry for the x- and y- axis or they can be set to autoscale.
- Allows an offset value to be entered for the selected trace.

NOTE

The Offset setting for a specific trace is displayed. The setting changes when the Trace changes.

Scale Tab

The screenshot shows the 'Options' dialog box with the 'Scale' tab selected. The dialog is titled 'Options' and has a close button in the top right corner. Below the title bar are six tabs: 'Scale', 'Units', 'Markers', 'Limits 1', 'Limits 2', and 'Labels'. The 'Scale' tab is active. The 'X-axis Scale' section contains an 'Autoscale' checkbox (unchecked), a 'Min:' field with the value '350', and a 'Max:' field with the value '3350'. The unit 'MHz' is displayed to the right. The 'Y-axis Scale' section contains an 'Autoscale' checkbox (unchecked), a 'Min:' field with the value '-77', and a 'Max:' field with the value '-27'. The unit 'dBm' is displayed to the right. The 'Offset' section contains a 'Trace:' dropdown menu with 'Backup SA' selected and an 'Offset (dB):' field with the value '0'. At the bottom of the dialog are 'OK' and 'Cancel' buttons.

Units Tab

- Units allows selection of unit of measure for the trace.
- Drawing options allow user to select the size of the text on the graph, marking data points on the trace, and displaying horizontal and vertical grid lines.

Units Tab

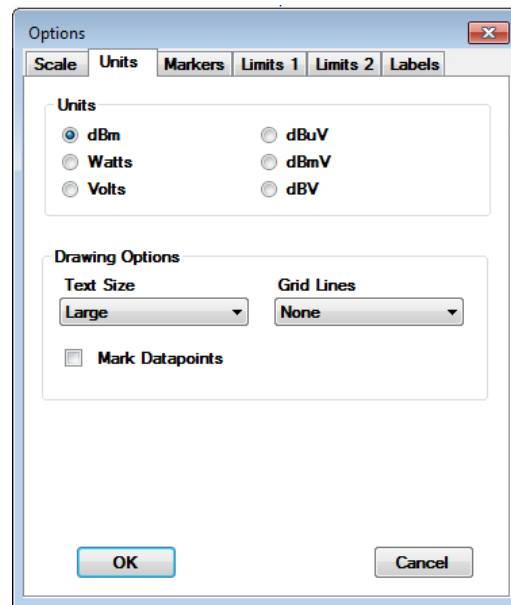

Markers Tab

When a frequency or distance for a marker is entered, the marker will be set to the datapoint closest to that frequency or distance. The actual frequency of the marker will replace the value entered and will also display on the screen below the graph area.

For each marker:

- Specify or change the frequency.
- Specify the symbol type.
- Specify a delta with another marker.
- Turn a marker on or off.

NOTE

After turning a marker on in the Options window, the marker can be moved by clicking on the marker and dragging it to a desired location.

Markers Tab

| | Frequency | On/Off | Type | Delta |
|-----------|-------------|-------------------------------------|------|-------|
| Marker 1: | 1850 | <input checked="" type="checkbox"/> | Line | Off |
| Marker 2: | 3345.738636 | <input type="checkbox"/> | Line | Off |
| Marker 3: | 3290.340909 | <input type="checkbox"/> | Line | Off |
| Marker 4: | 350 | <input type="checkbox"/> | Line | Off |
| Marker 5: | 350 | <input type="checkbox"/> | Line | Off |
| Marker 6: | 350 | <input type="checkbox"/> | Line | Off |

OK Cancel

Limits 1 Tab

Limits 1 Tab is used to define and turn on or off upper and lower limit lines.

NOTE

The options displayed on this tab will change slightly depending on the type of graph opened.

- The upper limit fails any datapoints that are above the line.
- The lower limit fails any datapoints that are below the line.
- The limit line will be flat across the graph at the power level specified.
- Predefined limits drop down menu contains a list of defined limit lines.

Limits 1 Tab

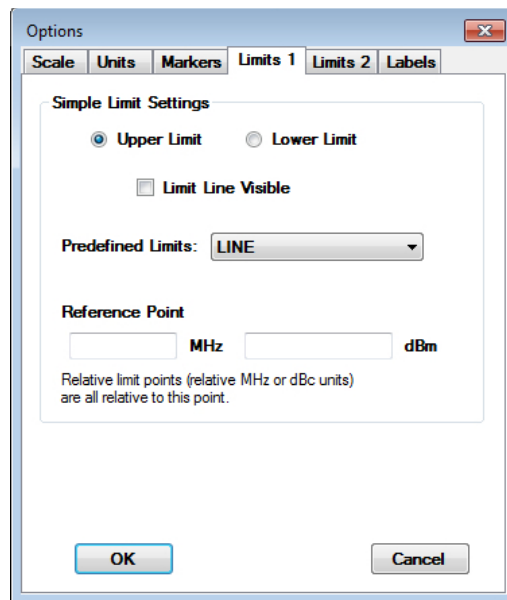

Limits 2 Tab

NOTE

The options displayed on this tab will change slightly depending on the type of graph opened.

- The upper limit fails any datapoints that are above the line.
- The lower limit fails any datapoints that are below the line.
- Up to thirty points, for both upper and lower limit lines can be set up. Using multiple points, a bracketed area may be created. See [Custom Limit Line Figure](#).

NOTE

If a limit line point is disabled, it is removed from the list in the Options dialog box.

Limits 2 Tab

| | X (MHz) | Y (dBm) | On/Off | Use relative power? |
|---|---------|---------|--------------------------|--------------------------|
| 1 | | | <input type="checkbox"/> | <input type="checkbox"/> |
| 2 | | | <input type="checkbox"/> | <input type="checkbox"/> |
| 3 | | | <input type="checkbox"/> | <input type="checkbox"/> |
| 4 | | | <input type="checkbox"/> | <input type="checkbox"/> |
| 5 | | | <input type="checkbox"/> | <input type="checkbox"/> |

Custom Limit Line

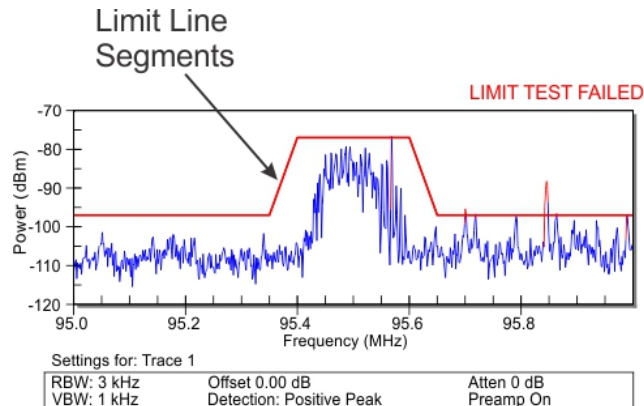

Labels Tab

- Creates a title, subtitle, and a trace name for the displayed trace.
- The title will be in larger letters and centered above the graph. The subtitle will be smaller.
- Edit a trace name by typing in the list of traces on this tab. The trace and date will be located above the graph and on the left.

NOTE

If a specific trace name is not created, the PC tool will create one automatically.

- Other options are to display or hide the title, subtitle, trace name, and trace date on the graph.

Labels Tab

Options

Scale Units Markers Limits 1 Limits 2 Labels

Title Show?

Subtitle

Show Trace Name?

Backup SA

Show Trace Date?

OK Cancel

Maintenance

Regular maintenance is essential for proper and accurate performance of the SignalHawk. These procedures cover the basic maintenance of the SignalHawk. For more advanced issues, please contact Bird Technologies customer service.

Cleaning

CAUTION

Harsh or abrasive detergents, and some solvents, can damage the unit and labels.

Clean the Bird SignalHawk only with a soft cloth dampened with mild detergent and water. Do not use any other type of cleaning solution.

Charging PC SignalHawk Battery

The internal battery pack will automatically recharge when the PC SignalHawk is powered from the AC or cigarette lighter adapter. Recharging time, from a full discharge, is approximately 4 hours.

Replace PC SignalHawk Battery

WARNING

Care should be taken when handling batteries

- Keep out of the reach of children.
- Do not heat or dispose of batteries in fire. May burst or release toxic materials.
- Avoid forced discharge.
- Do not short circuit.
- Restrict charging current and time to the recommended value.
- Do not solder the battery directly.
- Do not disassemble, apply excessive pressure, or deform battery.
- Avoid placing the battery in reverse polarity.
- Battery disposal method should be in accordance with local and state regulations.

1. Remove the four screws securing the back cover to the PC SignalHawk.
2. Remove the back cover.
3. Remove the battery pack.

CAUTION

Replace battery pack with identical battery pack (4 or 6 Cell). Use only manufacturer supplied battery pack with the same number of cells as the battery being removed.

NOTE

Note the number of cells in the battery pack you are removing. PC SignalHawk units manufactured in 2014 or before use a 6-cell battery pack, units manufactured in 2014 and after use a 4-cell battery pack.

4. Detach the power cord from the battery connector.
5. Reverse steps 1 to 4 to install a new battery.

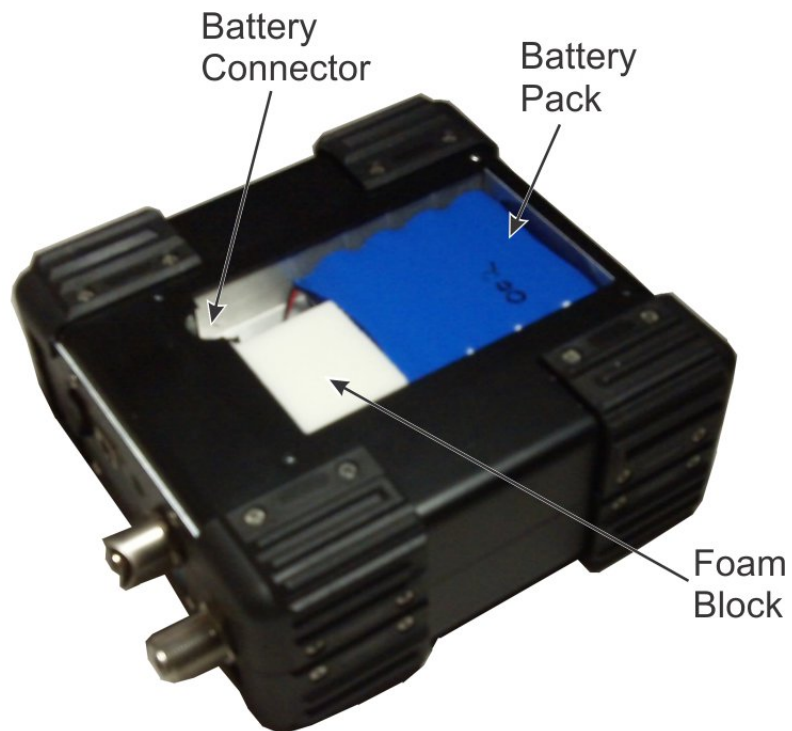
Battery Replacement

Update PC SignalHawk Firmware

NOTE

There are two different firmware files: one containing the DSP image and the other containing the FPGA image.

1. Navigate to Bird Technologies Group>PC SignalHawk in the Start menu.
2. Click on Firmware Update Wizard.

NOTE

The wizard will launch and provide step-by-step instructions

3. Select the DSP and FPGA images to be updated.

DSP and FPGA Image Selection

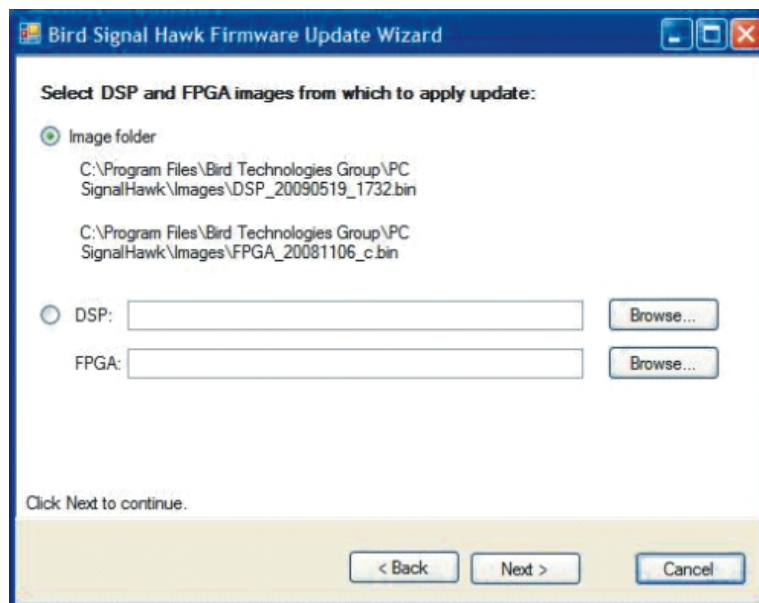

4. Connect the unit to the PC via USB cable.
5. Turn on the SignalHawk.
6. Select “Install the software automatically...” if the “Found New Hardware Wizard” is presented.

NOTE

Both program wizards will run concurrently. See [PC SignalHawk Set-Up](#).

7. Click “Next.”

DSP List

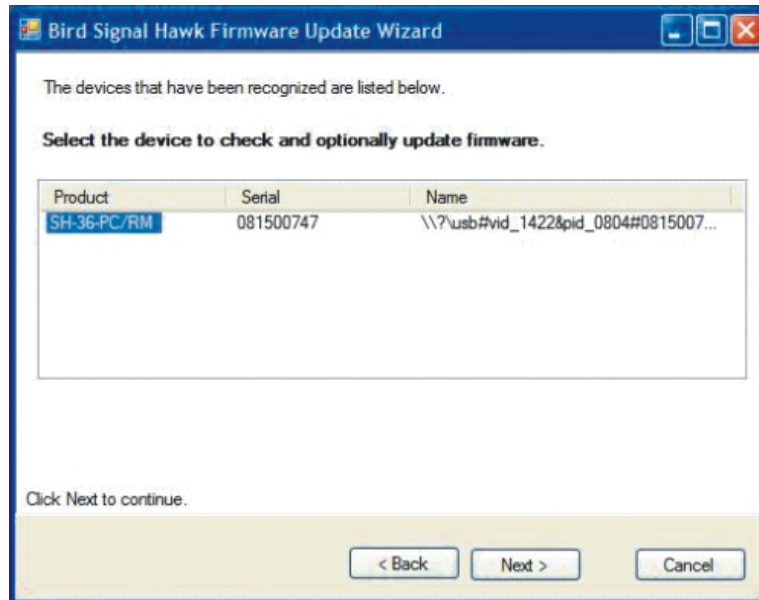

8. Select the unit from the list presented.
9. Select the images that need updating.

Image Selection

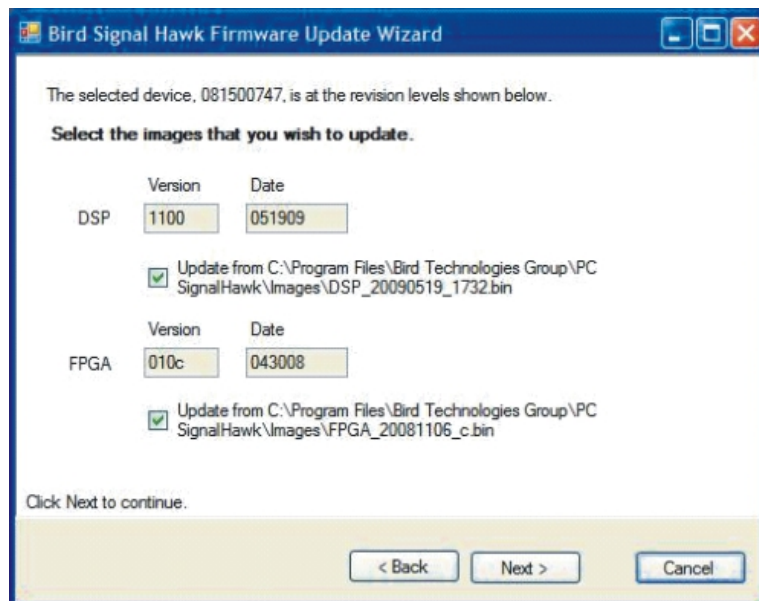

10. Click "Next" repeatedly until the update is completed.
11. Cycle power when prompted by the program wizard.

Update Rack Mount SignalHawk Firmware - Remotely

1. Go to Bird Technologies website to download the firmware.

www.birdrf.com

2. Download the Rack Mount SignalHawk software upgrade to a local PC.
3. Click Remote Desktop connection.
4. Click **Show Options** of the Remote Desktop Connection window.

Remote Desktop Connection Window



5. Click on Local Resources tab.
6. Click **More...** under the Local devices and resources group.

Remote Desktop Connection Window - Local Resources

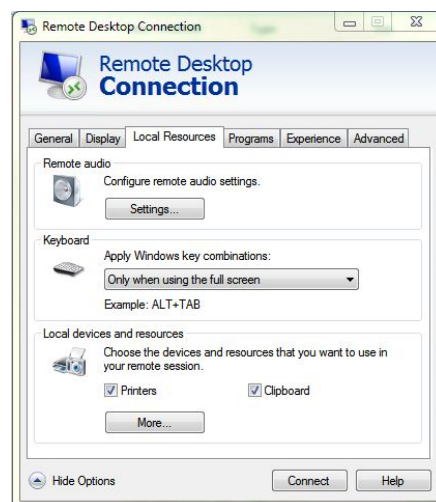

7. Select **Local Disk** under Drives, or the disk where the software was saved, if different.

NOTE

This will enable access of the local drives to the remote Rack Mount SignalHawk.

Remote Desktop Connection Window - Local Disk

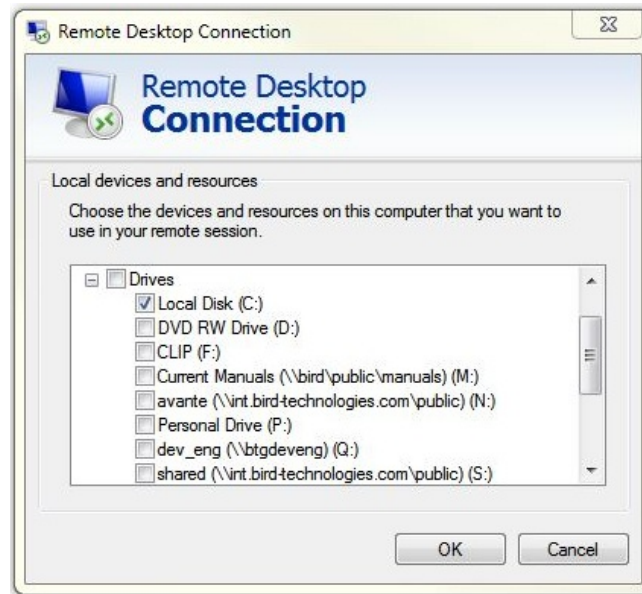

7. Click Okay.
8. Click the General tab in the Remote Desktop Connection window.
9. Connect the remote computer to the host computer. See "[Connecting a Remote Computer to the Host Computer](#)".
6. Click on the "Connect".
7. Click "OK" to access the local drives from the remote computer.
8. Log into the remote computer.
9. Stop the Rack Mount SignalHawk application.
10. Copy the SignalHawk software upgrade from the local PC to the Rack Mount SignalHawk
11. Double click "Setup" and follow the upgrade instructions.

Troubleshooting

Any service procedure not covered in this manual should be referred to an authorized service facility.

1. Locate the problem.
2. Review the possible causes.
3. Perform the action listed.

If the problem is not corrected, call Bird Service Center or return the unit for service.

| Problem | Possible Cause | Possible Correction |
|---|---|---|
| Unit will not power up. | AC adapter is damaged. | Replace the AC adapter. |
| | Battery is not fully charged or is damaged. | Allow battery to fully charge or replace the battery. See Replace PC SignalHawk Battery . |
| Self test fails. | Error condition. | Turn the unit off and then back on. If the problem persists, return the unit for service. |
| Keys do not respond. | Unit is "Locked Up". | Turn the unit off and then back on. |
| Unit turns off. | Internal error. | Turn the unit back on and continue. |
| | Unit was shut down because the battery was too low to operate the unit. | Operate the unit from the AC adapter. |
| Unit operates erratically. | System has become unstable. | Turn off power, wait 15 seconds, then reapply power. |
| Unit ceases to operate (locks up). | System has become unstable. | Turn off power, wait 15 seconds, then reapply power. |
| Unit gives inaccurate readings below 100 kHz. | Unit can be set below 100 kHz for user convenience, but accuracy spec does not apply below 100 kHz. | Do not use unit below 100 kHz. |
| Sweep is too slow. | Bandwidth set too low. | Increase BW. See Occupied Bandwidth Measurement . |
| Sweep stopped. | Sweep set to single-sweep or external trigger. | Set unit to continuous sweep, free rep trigger. See Sweep . |

Customer Service

Any maintenance or service procedure beyond the scope of those in this chapter should be referred to a qualified service center.

If you need to return the unit for any reason, request an RMA through the Bird Technologies website (link shown below). All instruments returned must be shipped prepaid and to the attention of the RMA number.

Bird Service Center

30303 Aurora Road

Cleveland (Solon), Ohio 44139-2794

Fax: (440) 248-5426

E-mail: bsc@birdrf.com

For the location of the Sales Office nearest you, visit our website at:

<http://www.birdrf.com>

Specifications

| Model Number | Model Name |
|--------------|-----------------------|
| SH-36S-RM | Rack-Mount SignalHawk |
| SH-36S-PC | PC SignalHawk |

SH-36S-RM

| Frequency | |
|-------------------|--|
| Range | 100 kHz to 3.6 GHz |
| Resolution | 1 Hz |
| Uncertainty | ± 1 ppm (2s) of measured frequency |
| Aging | ± 1 ppm / year (2s) |
| Temperature Drift | ± 1 ppm / C (2s) |
| Span | 1 kHz to 3.5999 GHz; 0 Hz (zero span) |

| | |
|---|---|
| Spectral Purity, Max @ 1 GHz 30 kHz from carrier 100 kHz from carrier 1 MHz from carrier | -85 dBc / (RBW Hz) ^{1/2} -100 dBc / (RBW Hz) ^{1/2} -124 dBc / (RBW Hz) ^{1/2} |
| Sweep Time: | 15.5 ms per data point to >2000 s, full span; 1 ms to 100 s, zero span |
| Displayed Data Points | 705 |
| Resolution Bandwidth (RBW): | 100 Hz to 1 MHz in 1, 3, 10 steps |
| Video Bandwidth (VBW): | 10 Hz to 300 kHz in 1, 3, 10 steps |
| Amplitude | |
| Display Range | -150 dBm to +30 dBm |
| Intermodulation-Free Dynamic Range | 66 dB; Third-order IM products, Two -20 dBm inputs, Reference = -10 dBm |
| Displayed Average Noise Level (DANL) | -135 dBm; 24 dB gain, 100 Hz RBW, 10 Hz VBW, average detection |
| Inherent Spurious | 80 dBm; reference d 10 dBm, f > 30 MHz, RBW d 100 kHz |
| Input Related Spurious | 70 dBc; mixer level d -30 dBm, carrier offset e 1 MHz |
| Reference Level | -140 dBm to +30 dBm |
| Attenuator | Built-in: 0, 10, 20, 30 dB |
| Pre-Amp | Built-in: +24 dB |
| Resolution dB-based units W or V-based units | 1 to 15 dB per division in 1 dB steps 1%, 2%, 5%, or 10% of reference level per division |
| Units | dBm, μW, mW, W, dBμV, dBmV, dBV, μV, mV, V, dB/m ² , μV/m ² |
| Offset Range | -99 to +99 dB |
| Accuracy | ± 1.5 dB max (2s), ±1.0 dB typical, >-50 dB ref, 15 to 35 C, max detector |
| Averaging | Running display average, 2 to 100 sweeps |
| Detection Modes | sample, +peak, peak, average, video average |

| Measurements | |
|---------------------------------------|--|
| Spectrum Analysis | Analyzes radio frequency spectrum. Measures intended and interfering signals. Allows setup of parameters such as frequency, amplitude and markers. Graphically displays signals amplitude vs. frequency and saves traces internally or to a compatible PC. Allows remote logging & monitoring. |
| Worldwide Applications | Cellular, PCS, DCS, 2 G, 3 G, CDMA, cdmaOne, CDMA 2000, 1x, 1x EV-DO, GSM, GPRS, EDGE, UMTS, HSDPA, W-CDMA, TDMA, AMPS as well as 802.11, Bluetooth, Broadcast, Emergency, Fire, GPS, Microwave, NPSPAC, Paging, Police, Private, Project 25, Public Safety, Tactical Military, Telematics, Tetra, Trunking, Utilities, WLAN and WLL. |
| Predefined Measurements | Spectrum Analysis, Occupied Bandwidth (OBW), Channel Power, Adjacent Channel Power Ratio (ACPR), Arbitrary Power Range, Field Strength, Zero Span, AM/FM Demodulation, Carrier-to-Interference Ratio (C/I), and Frequency Counter. The user manual includes step-by-step procedures for these one-button measurements as well as Out-of-Band Spurious and In-Band, Out-of-Channel Spurious measurements. |
| Help Functions | Help menu displays on-board user manual and customizable help files. |
| Travel Logging | Sample rate 60 to 3600 sec. |
| Internal Trace/Setup Storage Capacity | 140 Gb |
| Trigger Modes | Single, free run |
| Trigger Sources | Internal, external TTL, internal video |
| External Trigger Types | Rising edge, falling edge, any edge, trigger on HIGH, trigger on LOW |
| External Trigger Level | TTL Levels |
| External Trigger Delay | User-settable, 100 μ s to 1000 ms after trigger received before starting sweep |
| External Trigger Connector | BNC(F) |

| | |
|--------------------------------------|---|
| Markers | 6 Markers; Modes: On/Off, Standard, Marker to Max Peak, Marker to Next Peak, Marker Freq to Center, Marker Ampt to Ref Level, Marker Delta, Marker Type Line/Icon, Marker Noise, All Marker to Peaks, All Markers Off. Also, Marker to Max/Min Peak |
| User Interface | Reference the user manual and design specification for further details. |
| Warm-Up | Specifications apply after a 30 minute warm-up period at ambient temperature. |
| General Specifications | |
| Model | Name: Rack-Mount Signal Hawk Model: SH-36S-RM Description: Rack-Mount Spectrum Analyzer |
| Housing | Sheet metal |
| Power Switch | Momentary push-button |
| Power Indicator | Green LED |
| Connectors | N(F) for RF input Rear USB 2.0 Type B BNC(F) for external trigger RJ-45 for Ethernet Terminal strip for DC input One front & one rear RJ-45 for pass-through Ethernet connection |
| Additional Peripheral Connectors | 2.5mm Audio out (rear) VGA and DVI Video out (rear) USB ports (rear) DB 25 parallel port (rear) |
| Host Status Indicator | Multi-Colored LED's for individual host device power present |
| RF Input Impedance | 50 ohms, nominal |
| RF Input VSWR | 1.8:1 typ, 2.0:1 max (internal attenuator = 10dB or greater) |
| Max DC input | ± 50 V |
| Max RF input | +20 dBm; damage level is +30dBm for 30 sec. |
| Power Input | 120/240 VAC, IEC inlet 12 & 24/48 VDC, detachable screw terminal strip |
| Voltage Range and Power Requirements | 9-60 VDC, 75W peak 84-264 VAC, 75W peak |
| AC Fuse Options | Dual fuse line/neutral or single line fuse/neutral shorting bar (neutral un-fused) |

| | |
|---|--|
| Chassis Grounding Terminal | #10-32 x" UNC |
| Cooling Method | Forced air, front panel intake |
| Operating Temperature | 0 to 50 C (MIL-PRF-28800F, Class 3) |
| Storage Temperature | 20 to +80 C |
| Humidity, Max | 95% non-condensing (MIL-PRF-28800F, Class 2) |
| Altitude, Max | 4600m above sea level (MIL-PRF-28800F, Class 2) |
| Weight | 10.1 lbs. |
| Dimensions, Max | 19" x 10" x 3.5: thk (2 RU) |
| CE Compliance | 61326-2-1:2006 EMC (ESD immunity meets performance criteria C) 61010-1:2001 Safety 89/336/EEC - EMC 73/23/EEC and Amendment 93/68/EEC - Low Voltage |
| PC Software | |
| Built-In Operating System | Microsoft Windows 7, embedded |
| Client Hardware Requirements | <p>256 MB RAM & Pentium III or equivalent processor (512 MB RAM & Pentium 4/M or higher recommended) 800 x 600, 256 color display (1280 x 720, 16 bit or higher resolution recommended) Mouse or pointing device 100 MB free disk space. CD-ROM Drive (for client software installation) Adobe Acrobat Reader (for manual) Microsoft Windows XP, XPpro, Vista or 7. 10/100 base T LAN adaptor TCP/IP services Microsoft Remote Desktop Windows XP Sp2, XP pro only. 1 available USB port</p> |
| General | |
| Remote LAN/WAN Operation | |
| Local USB | |
| Direct Communication Method | USB |
| Remote Communication Method | TCP/IP, Windows Remote Desktop |
| Minimum Network Bandwidth for Remote Connection | 28.8 Kbps |
| Client Priority | Local USB client, single client only (local or remote) |

| Input | |
|--------------------|---|
| Connector | Precision N-F |
| RF Input Impedance | 50 ohms, nominal |
| RF Input VSWR | 1.8:1 typ, 2.0:1 max (internal attenuator = 10dB or greater) |
| Max DC Input | ± 50 V |
| Max RF Input | +20 dBm; damage level is +30dBm for 30 sec. |

Distortion & DANL

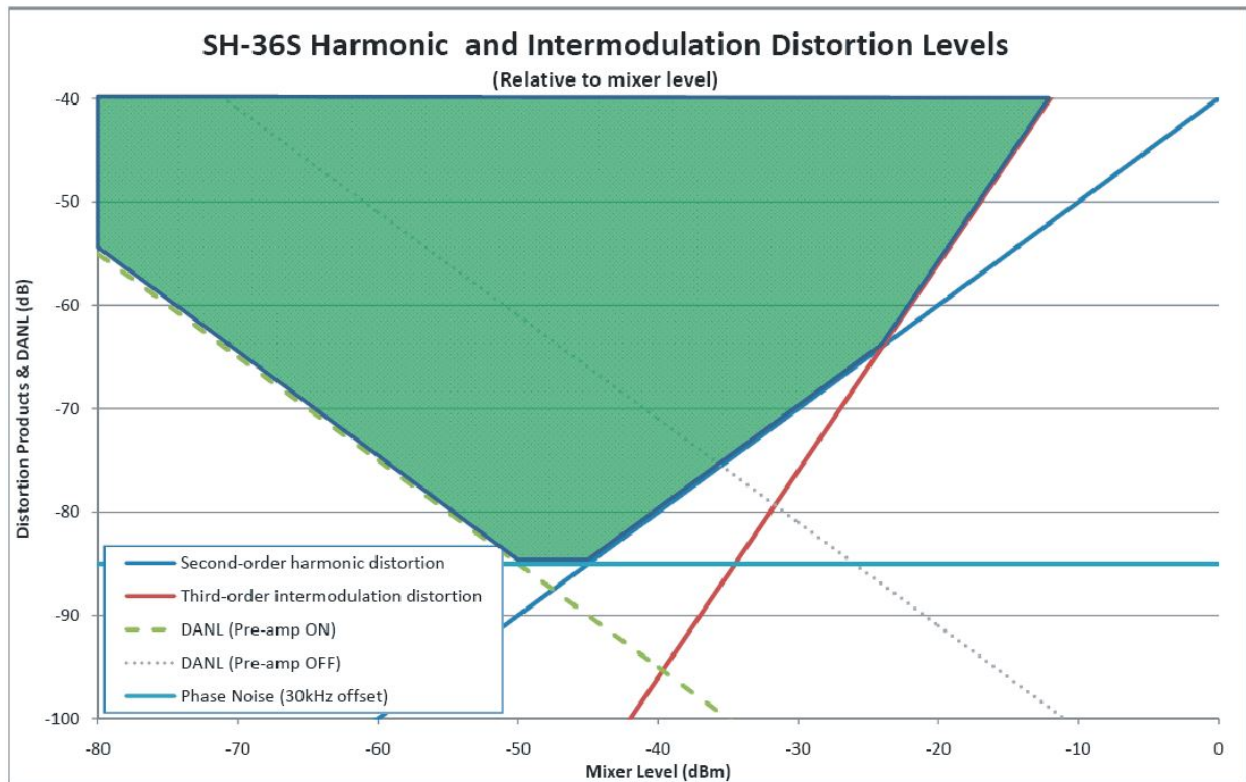

SH-36S-PC Specifications

| | Frequency |
|-------------------|---------------------------------------|
| Range | 100 kHz to 3.6 GHz |
| Resolution | 1 Hz |
| Uncertainty | ± 1 ppm (2s) of measured frequency |
| Aging | ± 1 ppm / year (2s) |
| Temperature Drift | ± 1 ppm / C (2s) |
| Span | 1 kHz to 3.5999 GHz; 0 Hz (zero span) |

| | |
|---|---|
| Spectral Purity, Max @ 1 GHz | -85 dBc / (RBW Hz) ^{1/2} -100 dBc / (RBW Hz) ^{1/2} -124 dBc / (RBW Hz) ^{1/2} |
| 30 kHz from Carrier 100 kHz from Carrier 1 MHz from Carrier | |
| Sweep Time | 15.5 ms per data point to >2000 s, full span; 1 ms to 100 s, zero span |
| Displayed Data Points | 705 |
| Resolution Bandwidth (RBW) | 100 Hz to 1 MHz in 1, 3, 10 steps |
| Video Bandwidth (VBW) | 10 Hz to 300 kHz in 1, 3, 10 steps |
| Amplitude | |
| Display Range | -150 dBm to +30 dBm |
| Intermodulation-Free Dynamic Range | 66 dB; Third-order IM products, Two -20 dBm inputs, Reference = -10 dBm |
| Displayed Average Noise Level (DANL) | -135 dBm; 24 dB gain, 100 Hz RBW, 10 Hz VBW, average detection |
| Inherent Spurious | 80 dBm; reference d 10 dBm, f > 30 MHz, RBW d 100 kHz |
| Input Related Spurious | 70 dBc; mixer level d -30 dBm, carrier offset e 1 MHz |
| Accuracy | ± 1.5 dB max (2s), ±1.0 dB typical, >-50 dB ref, 15 to 35 C, max detector |
| Reference Level | -140 dBm to +30 dBm |
| Attenuator | Built-in: 0, 10, 20, 30 dB |
| Pre-Amp | Built-in: +24 dB |
| Resolution | 1 to 15 dB per division in 1 dB steps |
| dB-based units W or V-based units | 1%, 2%, 5%, or 10% of ref level per division |
| Units | dBm, μW, mW, W, dBμV, dBmV, dBV, μV, mV, V, dB/m ² , μV/m ² |
| Offset Range | -99 to +99 dB |

| Measurements | |
|----------------------------|--|
| Spectrum Analysis | Analyzes radio frequency spectrum. Measures intended and interfering signals. Allows setup of parameters such as frequency, amplitude and markers. Graphically displays signal amplitude vs. frequency using a compatible PC. |
| Worldwide Applications | Cellular, PCS, DCS, 2G, 3G, 4G, CDMA, cdmaOne, CDMA 2000, 1x, 1x EV-DO, GSM, GPRS, EDGE, UMTS, HSDPA, W-CDMA, TDMA, AMPS, 802.11, Bluetooth, Broadcast, Emergency, Fire, GPS, HDTV, IBOC, In-Building, Lab, Microwave, NPSPAC, Paging, Police, Private, Project 25, Public Safety, Tactical Military, Telematics, Tetra, Trunking, Utilities, WiMAX, WLAN and WLL. |
| Predefined Measurements | Spectrum Analysis, Occupied Bandwidth (OBW), Channel Power, Adjacent Channel Power Ratio (ACPR), Arbitrary Power Range, Field Strength, Zero Span, AM/FM Demodulation, Carrier-to-Interference Ratio (C/I), and Frequency Counter. The user manual includes step-by-step procedures for these one-button measurements as well as Out-of-Band Spurious and In-Band, Out-of-Channel Spurious measurements. |
| Help Functions | Help menu displays on-board user manual and customizable help files. Tip line provides helpful hints with each key stroke. |
| Averaging | Running display average, 2 to 100 sweeps |
| Detection Modes | Sample, +peak, peak, average, video average |
| Trigger Modes | Single, free run |
| Trigger Sources | Internal, external TTL, internal video |
| External Trigger Types | Rising edge, falling edge, any edge, trigger on HIGH, trigger on LOW |
| External Trigger Level | TTL Levels |
| External Trigger Delay | User-settable, 100 μ s to 1000 ms after trigger received before starting sweep |
| External Trigger Connector | BNC(F) |
| Markers | 6 Markers; Modes: On/Off, Standard, Marker to Max Peak, Marker to Next Peak, Marker Freq to Center, Marker Ampt to Ref Level, Marker Delta, Marker Type Line/Icon, Marker Noise, All Marker to Peaks, All Markers Off. Also, Marker to Max/Min Peak |

| General Specifications | |
|-------------------------------|---|
| Model | Name: Hand-Held, PC SignalHawk Model: SH-36S-PC Description: PC-based Spectrum Analyzer |
| Housing | Aluminum Case, Plastic corner protectors |
| Power Indicator | Green LED |
| Charge Indicator | Green/Amber LED Amber: low battery or charging, Green: fully charged. |
| Connectors | N(F) for RF input 2.1 mm DC jack for AC adapter/charger external power USB Type B for PC connection BNC(F) for external trigger |
| RF Input Impedance | 50 ohms, nominal |
| RF Input VSWR | 1.8:1 typ, 2.0:1 max (internal attenuator = 10dB or greater) |
| Max DC Input | ± 50 V |
| Max RF Input | +20 dBm; damage level is +30dBm for 30 sec. |
| AC Adapter/Charger | External DC power supply, 12 VDC, 2 A, 2.1mm pin connector |
| Internal Battery | Rechargeable, field replaceable, lithium-ion battery. 5.5 hours continuous operation, 25C. |
| Warm-Up | Specifications apply after a 30 minute warm-up period at ambient temperature. Typical values are provided for reference and are not guaranteed. |
| Operating Temperature | 0 to 50 C (MIL-PRF-28800F, Class 3) |
| Storage Temperature | 20 to +80 C +Note: If storing above 60C for prolonged periods it is recommended that the battery be stored separately |
| Humidity, Max | 95% non-condensing (MIL-PRF-28800F, Class 2) |
| Altitude, Max | 4600m above sea level (MIL-PRF-28800F, Class 2) |
| Weight | 3 lbs |
| Dimensions, Max | 6.5" x 6.5" x 2.5" thk, not including connectors |
| CE Compliance | 61326:1997 +A1:1998 and A2:2001 EMC 61010-1:2001 Safety 89/336/EEC - EMC 73/23/EEC and Amendment 93/68/EEC - Low Voltage |
| Drop Tested | 1 meter drop in most severe position per EN 61010-1 |
| Transit Drop | 10 drops on corners and faces per MIL-PRF-28800F, Class 2 |

| | |
|---|---|
| Bench Handling | 4 drops on each face per MIL-PRF-28800F, Class 2 |
| Vibration | Random 10 to 500 Hz per MIL-PRF-28800F, Class 2 |
| Shock, Functional | 30 G half-sine shock pulse per MIL-PRF-28800F, Class 2 |
| PC Software | |
| Built-In Operating System | Microsoft Windows 7, embedded |
| Client Hardware Requirements | 256 MB RAM & Pentium III or equivalent processor (512 MB RAM & Pentium 4/M or higher recommended) |
| General | 800 x 600, 256 color display (1280 x 720, 16 bit or higher resolution recommended) |
| Remote LAN/WAN Operation | Mouse or pointing device |
| Local USB | 100 MB free disk space. |
| | CD-ROM Drive (for client software installation) |
| | Adobe Acrobat Reader (for manual) |
| | Microsoft Windows XP, XPpro, Vista or 7. |
| | 10/100 base T LAN adaptor |
| | TCP/IP services |
| | Microsoft Remote Desktop |
| | Windows XP Sp2, XP pro only. |
| | 1 available USB port |
| Direct Communication Method | USB |
| Remote Communication Method | TCP/IP, Windows Remote Desktop |
| Minimum Network Bandwidth for Remote Connection | 28.8 Kbps |
| Client Priority | Local USB client, single client only (local or remote) |

Parts List

Note: Contact Bird Service Center for parts information.

Standard Accessories

| Description | Part No. | Qty |
|--|------------------------------|-----|
| Operations Manual - PDF electronic copy ¹ | 920-36S-RM-ASL | 1 |
| Start-Up Instructions ¹ | 920-SHPC-REF | 1 |
| AC Line Cord | 4421-055 | 1 |
| USB Cable, 10 ft, USB 2.0 certified, USB A male to USB B male | 5A2653-10 | 1 |
| AC Adapter/Charger, input 100-240 VAC @ 50-60Hz ² output +15 V, 5 A (2014 and earlier models with 6-cell battery pack) output +12 V, 2 A (2014 and later models with 4-cell battery pack) NOTE AC Adapters are not interchangeable. | 5A2436 5B2229-1224G-1 | 1 |
| RJ45 Ethernet Cable ³ | 5A2744-S07 | 1 |
| PC Hawk Emulator Software CD | 7002A153 | 1 |
| Cigarette Lighter Adapter ² | 5A2238-3 | 1 |
| Internal Li-Ion Field Replaceable Battery ² 6-cell battery pack (2014 and earlier models) 4-cell battery pack (2014 and later models) NOTE Battery packs are not interchangeable. | 5B2431 5C2431-2 | 1 |
| Fuse, 5x20 mm SLO-BLO ³ | 5A2257-17 | 1 |
| Fuse Drawer ³ | 5A2821-F6 | 1 |
| Fuse Drawer with Shorting Bar ³ | 5A2821-F7 | 1 |

¹ Spare standard accessories are available as optional accessories. Manuals, software, and firmware updates are available at: www.birdrf.com.

² For SH-36S-PC only.

³ For SH-36S-RM only.

Optional Accessories**SH-36S-PC****General**

| Description | Part No. | Qty |
|--|-----------------|------------|
| Field Strength Antenna, 136 to 221 MHz, Field Tunable, 0 dB Gain | ANT-100 | 1 |
| Field Strength Antenna, 400 to 512 MHz, Field Tunable, 0 dB Gain | ANT-400 | 1 |
| Field Strength Antenna, 824 to 894 MHz, 0 dB Gain, Articulating | ANT-800 | 1 |
| Field Strength Antenna, 890 to 960 MHz, 0 dB Gain, Articulating | ANT-900 | 1 |
| Field Strength Antenna, 1710 to 1880 MHz, 0 dB Gain, Articulating | ANT-1800 | 1 |
| Field Strength Antenna, 1850 to 1990 MHz, 0 dB Gain, Articulating | ANT-1900 | 1 |
| Field Strength Antenna, 2400 to 2500 MHz, 0 dB Gain, Articulating | ANT-2400 | 1 |
| Attenuator, 100 W, 40 dB, NM/NF, 2.4 GHz | 100-SA-MFN-40 | 1 |
| Attenuator, 50 W, 30 dB, NM/NF, 4 GHz | 50-A-MFN-30 | 1 |
| Attenuator, 25 W, 30 dB, NM/NF, 4 GHz | 25-A-MFN-30 | 1 |
| Attenuator, 10 W, 30 dB, NM/NF, 4 GHz | 10-A-MFN-30 | 1 |
| Attenuator, 5 W, 20 dB, NM/NF, 4 GHz | 5-A-MFN-20 | 1 |
| Attenuator, 2 W, 20 dB, NM/NF, 4 GHz | 2-A-MFN-20 | 1 |

Note: Recommend N(M) to SMA(F) adapter (model 4240-500-10) for field strength antennas.

Test Cables and Adapters

| Description | Part No. | Qty |
|---|-----------------|------------|
| Test Cable, Phase Stable, 1.5 m, N(M) to N(F) | TC-MNFN-1.5 | 1 |
| Test Cable, Phase Stable, 3.0 m, N(M) to N(F) | TC-MNFN-3.0 | 1 |
| Test Cable, Phase Stable, 1.5 m, N(M) to N(M) | TC-MNMN-1.5 | 1 |
| Test Cable, Phase Stable, 3.0 m, N(M) to N(M) | TC-MNMN-3.0 | 1 |
| Test Cable, Phase Stable, 1.5 m, N(M) to 7/16 DIN(F) | TC-MNFE-1.5 | 1 |
| Test Cable, Phase Stable, 3.0 m, N(M) to 7/16 DIN(F) | TC-MNFE-3.0 | 1 |

| | | |
|--|-------------|---|
| Test Cable, Phase Stable, 1.5 m, N(M) to 7/16 DIN(M) | TC-MNME-1.5 | 1 |
| Test Cable, Phase Stable, 3.0 m, N(M) to 7/16 DIN(M) | TC-MNME-3.0 | 1 |
| Adapter, N(M) to 7/16 DIN(M) | PA-MNME | 1 |
| Adapter, N(F) to 7/16 DIN(M) | PA-FNME | 1 |
| Adapter, N(M) to 7/16 DIN(F) | PA-MNFE | 1 |
| Adapter, N(F) to 7/16 DIN(F) | PA-FNFE | 1 |
| Adapter Kit, 7/16 DIN | 4240-550 | 1 |
| Adapter, N(F) to N(F) | 4240-500-1 | 1 |
| Adapter, N(M) to N(M) | 4240-500-2 | 1 |
| Adapter, N(M) to SMA(F) | 4240-500-10 | 1 |

Note: All specifications are subject to change without notice.

SH-36S-RM

General

| Description | Part No. | Qty |
|---|---------------|-----|
| USB Cable, 10 ft, USB 2.0 certified, USB A male to USB B male | 5A2653-10 | 1 |
| Attenuator, 100 W, 40 dB, NM/NF, 2.4 GHz | 100-SA-MFN-40 | 1 |
| Attenuator, 50 W, 30 dB, NM/NF, 4 GHz | 50-A-MFN-30 | 1 |
| Attenuator, 25 W, 30 dB, NM/NF, 4 GHz | 25-A-MFN-30 | 1 |
| Attenuator, 10 W, 30 dB, NM/NF, 4 GHz | 10-A-MFN-30 | 1 |
| Attenuator, 5 W, 20 dB, NM/NF, 4 GHz | 5-A-MFN-20 | 1 |
| Attenuator, 2 W, 20 dB, NM/NF, 4 GHz | 2-A-MFN-20 | 1 |

Test Cables and Adapters

| Description | Part No. | Qty |
|--|-------------|-----|
| Test Cable, Phase Stable, 1.5 m, N(M) to N(F) | TC-MNFN-1.5 | 1 |
| Test Cable, Phase Stable, 3.0 m, N(M) to N(F) | TC-MNFN-3.0 | 1 |
| Test Cable, Phase Stable, 1.5 m, N(M) to N(M) | TC-MNMM-1.5 | 1 |
| Test Cable, Phase Stable, 3.0 m, N(M) to N(M) | TC-MNMM-3.0 | 1 |
| Test Cable, Phase Stable, 1.5 m, N(M) to 7/16 DIN(F) | TC-MNFE-1.5 | 1 |
| Test Cable, Phase Stable, 3.0 m, N(M) to 7/16 DIN(F) | TC-MNFE-3.0 | 1 |
| Test Cable, Phase Stable, 1.5 m, N(M) to 7/16 DIN(M) | TC-MNME-1.5 | 1 |

| | | |
|--|-------------|---|
| Test Cable, Phase Stable, 3.0 m, N(M) to 7/16 DIN(M) | TC-MNME-3.0 | 1 |
| Adapter, N(M) to 7/16 DIN(M) | PA-MNME | 1 |
| Adapter, N(F) to 7/16 DIN(M) | PA-FNME | 1 |
| Adapter, N(M) to 7/16 DIN(F) | PA-MNFE | 1 |
| Adapter, N(F) to 7/16 DIN(F) | PA-FNFE | 1 |
| Adapter Kit, 7/16 DIN | 4240-550 | 1 |
| Adapter, N(F) to N(F) | 4240-500-1 | 1 |
| Adapter, N(M) to N(M) | 4240-500-2 | 1 |
| Adapter, N(M) to SMA(F) | 4240-500-10 | 1 |

ROHS

| Part Name | Toxic or hazardous Substances and Elements | | | | | |
|--------------------------|--|--------------|--------------|------------------------------|--------------------------------|---------------------------------------|
| | Lead (Pb) | Mercury (Hg) | Cadmium (Cd) | Hexavalent Chromium (Cr(VI)) | Polybrominated biphenyls (PBB) | Polybrominated diphenyl ethers (PBDE) |
| Copper Alloy | X | O | O | O | O | O |
| Florescent Backlight | O | X | O | O | O | O |
| Printed Circuit Assembly | X | O | O | O | O | O |

O: Indicates that this toxic or hazardous substance contained in all of the homogeneous materials for this part is below the limit requirement in SJ/T11363-2006.

X: Indicates that this toxic or hazardous substance contained in at least one of the homogeneous materials used for this part is above the limit requirements in SJ/T11363-2006.

Software License Terms

MICROSOFT SOFTWARE LICENSE TERMS WINDOWS 7 PROFESSIONAL

These license terms are an agreement between Microsoft Corporation (or based on where you live, one of its affiliates) and you. Please read them. They apply to the software named above, which includes the media on which you received it, if any. Printed-paper license terms, which may come with the software, may replace or modify any on-screen license terms. The terms also apply to any Microsoft

- updates,
- supplements,
- Internet-based services, and
- support services

for this software, unless other terms accompany those items. If so, those terms apply.

By using the software, you accept these terms. If you do not accept them, do not use the software. Instead, return it to the retailer for a refund or credit. If you cannot obtain a refund there, contact Microsoft or the Microsoft affiliate serving your country for information about Microsoft's refund policies. See www.microsoft.com/worldwide. In the United States and Canada, call (800) MICROSOFT or see www.microsoft.com/info/nareturns.htm.

As described below, using the software also operates as your consent to the transmission of certain computer information during activation, validation and for Internet-based services.

If you comply with these license terms, you have the rights below for each license you acquire.

1. OVERVIEW.

- Software.** The software includes desktop operating system software. This software does not include Windows Live services. Windows Live is a service available from Microsoft under a separate agreement.
- License Model.** The software is licensed on a per copy per computer basis. A computer is a physical hardware system with an internal storage device capable of running the software. A hardware partition or blade is considered to be a separate computer.

2. INSTALLATION AND USE RIGHTS.

- One Copy per Computer.** You may install one copy of the software on one computer. That computer is the "licensed computer."

- b. **Licensed Computer.** You may use the software on up to two processors on the licensed computer at one time. Unless otherwise provided in these license terms, you may not use the software on any other computer.
- c. **Number of Users.** Unless otherwise provided in these license terms, only one user may use the software at a time.
- d. **Alternative Versions.** The software may include more than one version, such as 32-bit and 64-bit. You may install and use only one version at one time.

3. **ADDITIONAL LICENSING REQUIREMENTS AND/OR USE RIGHTS.**

- a. Multiplexing. Hardware or software you use to
 - pool connections, or
 - reduce the number of devices or users that directly access oruse the software (sometimes referred to as “multiplexing” or “pooling”), does not reduce the number of licenses you need.
- b. Font Components. While the software is running, you may use its fonts to display and print content. You may only
 - embed fonts in content as permitted by the embedding restrictions in the fonts; and
 - temporarily download them to a printer or other output device to print content.
- c. Icons, images and sounds. While the software is running, you may use but not share its icons, images, sounds, and media. The sample images, sounds and media provided with the software are for your non-commercial use only.
- d. Use with Virtualization Technologies. Instead of using the software directly on the licensed computer, you may install and use the software within only one virtual (or otherwise emulated) hardware system on the licensed computer. When used in a virtualized environment, content protected by digital rights management technology, BitLocker or any full volume disk drive encryption technology may not be as secure as protected content not in a virtualized environment. You should comply with all domestic and international laws that apply to such protected content.
- e. Storage. you may store one copy of th software on a storage device, such as network server. you may use that copy to install the software on any other computer to which a license has been assigned.
- f. Device Connections. You may allow up to 20 other devices to access software installed on the licensed computer to use only File Services, Print Services, Internet Information Services and Internet Connection Sharing and Telephony Services.
- g. Remote Access Technologies. You may access and use the software installed on the licensed computer remotely from another device using remote access technologies as follows.

- Remote Desktop. The single primary user of the licensed computer may access a session from any other device using Remote Desktop or similar technologies. A “session” means the experience of interacting with the software, directly or indirectly, through any combination of input, output and display peripherals. Other users may access a session from any device using these technologies, if the remote device is separately licensed to run the software.
 - Other Access Technologies. You may use Remote Assistance or similar technologies to share an active session.
- h. Media Center Extender. You may have five Media Center Extender Sessions (or other software or devices which provide similar functionality for a similar purpose) running at the same time to display the software user interface or content on other displays or devices.
 - i. Electronic Programming Guide. If the software includes access to an electronic programming guide service that displays customized television listings, a separate service agreement applies to the service. If you do not agree to the terms of the service agreement, you may continue to use the software, but you will not be able to use the electronic programming guide service. The service may contain advertising content and related data, which are received and stored by the software. The service is not available in all areas. Please consult the software information for instructions on accessing the service agreement.
 - j. Related Media Information. If you request related media information as part of your playback experience, the data provided to you may not be in your local language. Some countries or regions have laws and regulations which may restrict or limit your ability to access certain types of content.
 - k. Worldwide Use of the Media Center. Media Center is not designed for use in every country. For example, although the Media Center information may refer to certain features such as an electronic programming guide or provide information on how to configure a TV tuner, these features may not work in your area. Please refer to the Media Center information for a list of features that may not work in your area.

4. MANDATORY ACTIVATION.

Activation associates the use of the software with a specific computer. During activation, the software will send information about the software and the computer to Microsoft. This information includes the version, language and product key of the software, the Internet protocol address of the computer, and information derived from the hardware configuration of the computer.

For more information, see go.microsoft.com/fwlink/?Linkid=104609.

By using the software, you consent to the transmission of this information. If properly licensed, you have the right to use the version of the software installed during the installation process up to the time permitted for activation. **Unless the software is activated, you have no right to use the software after the time permitted for**

activation. This is to prevent its unlicensed use. **You are not permitted to bypass or circumvent activation.** If the computer is connected to the Internet, the software may automatically connect to Microsoft for activation. You can also activate the software manually by Internet or telephone. If you do so, Internet and telephone service charges may apply. Some changes to your computer components or the software may require you to reactivate the software. **The software will remind you to activate it until you do.**

5. VALIDATION.

- a. Validation verifies that the software has been activated and is properly licensed. It also verifies that no unauthorized changes have been made to the validation, licensing, or activation functions of the software. Validation may also check for certain malicious or unauthorized software related to such unauthorized changes. A validation check confirming that you are properly licensed permits you to continue to use the software, certain features of the software or to obtain additional benefits. **You are not permitted to circumvent validation.** This is to prevent unlicensed use of the software. For more information, see go.microsoft.com/fwlink/?Linkid=104610.
- b. The software will from time to time perform a validation check of the software. The check may be initiated by the software or Microsoft. To enable the activation function and validation checks, the software may from time to time require updates or additional downloads of the validation, licensing or activation functions of the software. The updates or downloads are required for the proper functioning of the software and may be downloaded and installed without further notice to you. During or after a validation check, the software may send information about the software, the computer and the results of the validation check to Microsoft. This information includes, for example, the version and product key of the software, any unauthorized changes made to the validation, licensing or activation functions of the software, any related malicious or unauthorized software found and the Internet protocol address of the computer. Microsoft does not use the information to identify or contact you. By using the software, you consent to the transmission of this information. For more information about validation and what is sent during or after a validation check, see go.microsoft.com/fwlink/?Linkid=104611.
- c. If, after a validation check, the software is found to be counterfeit, improperly licensed, a non-genuine Windows product, or include unauthorized changes, the functionality and experience of using the software will be affected, for example:

Microsoft may

- repair the software, remove, quarantine or disable any unauthorized changes that may interfere with the proper use of the software, including circumvention of the activation or validation functions of the software, or
- check and remove malicious or unauthorized software known to be related to such unauthorized changes, or

- provide notices that the software is improperly licensed or a non-genuine Windows product

and you may

- receive reminders to obtain a properly licensed copy of the software, or
- need to follow Microsoft's instructions to be licensed to use the software and reactivate,

and you may not be able to

- use or continue to use the software or some of the features of the software, or
 - obtain certain updates or upgrades from Microsoft
- d. You may only obtain updates or upgrades for the software from Microsoft or authorized sources. For more information on obtaining updates from authorized sources see go.microsoft.com/fwlink/?Linkid=104612.

6. **POTENTIALLY UNWANTED SOFTWARE.** If turned on, Windows Defender will search your computer for “spyware,” “adware” and other potentially unwanted software. If it finds potentially unwanted software, the software will ask you if you want to ignore, disable (quarantine) or remove it. Any potentially unwanted software rated “high” or “severe,” will automatically be removed after scanning unless you change the default setting. Removing or disabling potentially unwanted software may result in
- other software on your computer ceasing to work, or
 - your breaching a license to use other software on your computer.

By using this software, it is possible that you will also remove or disable software that is not potentially unwanted software.

7. **INTERNET-BASED SERVICES.** Microsoft provides Internet-based services with the software. It may change or cancel them at any time.
- a. **Consent for Internet-Based Services.** The software features described below and in the Windows 7 Privacy Statement connect to Microsoft or service provider computer systems over the Internet. In some cases, you will not receive a separate notice when they connect. In some cases, you may switch off these features or not use them. For more information about these features, see the Windows 7 Privacy Statement at go.microsoft.com/fwlink/?linkid=104604.

By using these features, you consent to the transmission of this information. Microsoft does not use the information to identify or contact you.

Computer Information. The following features use Internet protocols, which send to the appropriate systems computer information, such as your Internet

protocol address, the type of operating system, browser and name and version of the software you are using, and the language code of the computer where you installed the software. Microsoft uses this information to make the Internet-based services available to you.

- **Plug and Play and Plug and Play Extensions.** You may connect new hardware to your computer, either directly or over a network. Your computer may not have the drivers needed to communicate with that hardware. If so, the update feature of the software can obtain the correct driver from Microsoft and install it on your computer. An administrator can disable this update feature.
- **Windows Update.** To enable the proper functioning of the Windows Update service in the software (if you use it), updates or downloads to the Windows Update service will be required from time to time and downloaded and installed without further notice to you.
- **Web Content Features.** Features in the software can retrieve related content from Microsoft and provide it to you. Examples of these features are clip art, templates, online training, online assistance and Appshelp. You may choose not to use these web content features.
- **Digital Certificates.** The software uses digital certificates. These digital certificates confirm the identity of Internet users sending X.509 standard encrypted information. They also can be used to digitally sign files and macros, to verify the integrity and origin of the file contents. The software retrieves certificates and updates certificate revocation lists over the Internet, when available.
- **Auto Root Update.** The Auto Root Update feature updates the list of trusted certificate authorities. You can switch off the Auto Root Update feature.
- **Windows Media Digital Rights Management.** Content owners use Windows Media digital rights management technology (WMDRM) to protect their intellectual property, including copyrights. This software and third party software use WMDRM to play and copy WMDRM-protected content. If the software fails to protect the content, content owners may ask Microsoft to revoke the software's ability to use WMDRM to play or copy protected content. Revocation does not affect other content. When you download licenses for protected content, you agree that Microsoft may include a revocation list with the licenses. Content owners may require you to upgrade WMDRM to access their content. Microsoft software that includes WMDRM will ask for your consent prior to the upgrade. If you decline an upgrade, you will not be able to access content that requires the upgrade. You may switch off WMDRM features that access the Internet. When these features are off, you can still play content for which you have a valid license.

- **Windows Media Player.** When you use Windows Media Player, it checks with Microsoft for
 - compatible online music services in your region; and
 - new versions of the player.
 - For more information, go to go.microsoft.com/fwlink/?Linkid=104605.
- **Malicious Software Removal.** During setup, if you select “Get important updates for installation”, the software may check and remove certain malware from your computer. “Malware” is malicious software. If the software runs, it will remove the Malware listed and updated at www.support.microsoft.com/?kbid=890830. During a Malware check, a report will be sent to Microsoft with specific information about Malware detected, errors, and other information about your computer. This information is used to improve the software and other Microsoft products and services. No information included in these reports will be used to identify or contact you. You may disable the software's reporting functionality by following the instructions found at www.support.microsoft.com/?kbid=890830.

For more information, read the Windows Malicious Software Removal Tool privacy statement at go.microsoft.com/fwlink/?LinkId=113995.

- **Network Awareness.** This feature determines whether a system is connected to a network by either passive monitoring of network traffic or active DNS or HTTP queries. The query only transfers standard TCP/IP or DNS information for routing purposes. You can switch off the active query feature through a registry setting.
- **Windows Time Service.** This service synchronizes with time.windows.com once a week to provide your computer with the correct time. You can turn this feature off or choose your preferred time source within the Date and Time Control Panel applet. The connection uses standard NTP protocol.
- **IPv6 Network Address Translation (NAT) Traversal service (Teredo).** This feature helps existing home Internet gateway devices transition to IPv6. IPv6 is next generation Internet protocol. It helps enable end-to-end connectivity often needed by peer-to-peer applications. To do so, each time you start up the software the Teredo client service will attempt to locate a public Teredo Internet service. It does so by sending a query over the Internet. This query only transfers standard Domain Name Service information to determine if your computer is connected to the Internet and can locate a public Teredo service. If you
 - use an application that needs IPv6 connectivity or
 - configure your firewall to always enable IPv6 connectivity

by default standard Internet Protocol information will be sent to the Teredo service at Microsoft at regular intervals. No other information is sent to Microsoft. You can change this default to use non-Microsoft servers. You can also switch off this feature using a command line utility named “netsh”.

- **Accelerators.** When you click on or move your mouse over an Accelerator in Internet Explorer, any of the following may be sent to the service provider:
 - the title and full web address or URL of the current web-page,
 - standard computer information, and
 - any content you have selected.

If you use an Accelerator provided by Microsoft, use of the information sent is subject to the Microsoft Online Privacy Statement. This statement is available at go.microsoft.com/fwlink/?linkid=31493.

If you use an Accelerator provided by a third party, use of the information sent will be subject to the third party's privacy practices.

- **Search Suggestions Service.** In Internet Explorer, when you type a search query in the Instant Search box or type a question mark (?) before your search term in the Address bar, you will see search suggestions as you type (if supported by your search provider). Everything you type in the Instant Search box or in the Address bar when preceded by a question mark (?) is sent to your search provider as you type. Also, when you press Enter or click the Search button, the text in the Instant Search box or Address bar is sent to the search provider. If you use a Microsoft search provider, use of the information sent is subject to the Microsoft Online Privacy Statement. This statement is available at

go.microsoft.com/fwlink/?linkid=31493.

If you use a third-party search provider, use of the information sent will be subject to the third party's privacy practices. You can turn search suggestions off at any time. To do so, use Manage Add-ons under the Tools button in Internet Explorer. For more information about the search suggestions service, see go.microsoft.com/fwlink/?linkid=128106.

- **Consent to Update Infrared Emitter/Receiver.** The software may contain technology to ensure proper functioning of the infrared emitter/receiver device shipped with certain Media Center-based products. You agree that the software may update the firmware of this device.

- **Media Center Online Promotions.** If you use Media Center features of the software to access Internet-based content or other Internet-based services, such services may obtain the following information from the software to enable you to receive, accept and use certain promotional offers:
 - certain computer information, such as your Internet protocol address, the type of operating system and browser you are using, and the name and version of the software you are using,
 - the requested content, and
 - the language code of the computer where you installed the software.

Your use of the Media Center features to connect to those services serves as your consent to the collection and use of such information.

- b. **Use of Information.** Microsoft may use the computer information, accelerator information, search suggestions information, error reports, and Malware reports to improve our software and services. We may also share it with others, such as hardware and software vendors. They may use the information to improve how their products run with Microsoft software.
 - c. **Misuse of Internet-based Services.** You may not use these services in any way that could harm them or impair anyone else's use of them. You may not use the services to try to gain unauthorized access to any service, data, account or network by any means.
8. **SCOPE OF LICENSE.** The software is licensed, not sold. This agreement only gives you some rights to use the features included in the software edition you licensed. Microsoft reserves all other rights. Unless applicable law gives you more rights despite this limitation, you may use the software only as expressly permitted in this agreement. In doing so, you must comply with any technical limitations in the software that only allow you to use it in certain ways. You may not
- work around any technical limitations in the software;
 - reverse engineer, decompile or disassemble the software, except and only to the extent that applicable law expressly permits, despite this limitation;
 - use components of the software to run applications not running on the software;
 - make more copies of the software than specified in this agreement or allowed by applicable law, despite this limitation;
 - publish the software for others to copy;
 - rent, lease or lend the software; or
 - use the software for commercial software hosting services.
9. **MICROSOFT .NET BENCHMARK TESTING.** The software includes one or more components of the .NET Framework (“.NET Components”). You may conduct internal benchmark testing of those components. You may disclose the results of any benchmark test of those components, provided that you comply with the conditions set forth at

go.microsoft.com/fwlink/?LinkID=66406. Notwithstanding any other agreement you may have with Microsoft, if you disclose such benchmark test results, Microsoft shall have the right to disclose the results of benchmark tests it conducts of your products that compete with the applicable .NET Component, provided it complies with the same conditions set forth at go.microsoft.com/fwlink/?LinkID=66406.

10. BACKUP COPY.

- a. **Media.** If you acquired the software on a disc or other media, you may make one backup copy of the media. You may use it only to reinstall the software on the licensed computer.
- b. **Electronic Download.** If you purchased and downloaded the software online, you may make one copy of the software on a disc or other media in order to install the software on a computer. You may also use it to reinstall the software on the licensed computer.

11. DOCUMENTATION. Any person that has valid access to your computer or internal network may copy and use the documentation for your internal, reference purposes.

12. NOT FOR RESALE SOFTWARE. You may not sell software marked as “NFR” or “Not for Resale.”

13. ACADEMIC EDITION SOFTWARE. You must be a “Qualified Educational User” to use software marked as “Academic Edition” or “AE.” If you do not know whether you are a Qualified Educational User, visit www.micro-soft.com/education or contact the Microsoft affiliate serving your country.

14. GEOGRAPHIC RESTRICTIONS. If the software is marked as requiring activation in a specific geographic region, then you are only permitted to activate this software in the geographic region indicated on the software packaging. You may not be able to activate the software outside of that region. For further information on geographic restrictions, visit go.microsoft.com/fwlink/?LinkId=141397.

15. UPGRADES. To use upgrade software, you must first be licensed for the software that is eligible for the upgrade. Upon upgrade, this agreement takes the place of the agreement for the software you upgraded from. After you upgrade, you may no longer use the software you upgraded from.

16. PROOF OF LICENSE.

- a. **Genuine Proof of License.** If you acquired the software on a disc or other media, your proof of license is the genuine Microsoft certificate of authenticity label with the accompanying genuine product key, and your proof of purchase. If you purchased and downloaded the software online, your proof of license is the genuine Microsoft product key for the software which you received with your purchase, and your proof of purchase from an authorized electronic supplier of genuine Microsoft software. Proof of purchase may be subject to verification by your merchant's records.
- b. **Windows Anytime Upgrade License.** If you upgrade the software using Windows Anytime Upgrade, your proof of license is the proof of license for the software you upgraded from, your Windows Anytime Upgrade product key and your proof

of purchase. Proof of purchase may be subject to verification by your merchant's records.

- c. To identify genuine Microsoft software, see www.howtotell.com.

17. TRANSFER TO ANOTHER COMPUTER.

- a. **Software Other than Windows Anytime Upgrade.** You may transfer the software and install it on another computer for your use. That computer becomes the licensed computer. You may not do so to share this license between computers.
- b. **Windows Anytime Upgrade Software.** You may transfer the software and install it on another computer, but only if the license terms of the software you upgraded from allows you to do so. That computer becomes the licensed computer. You may not do so to share this license between computers.

18. TRANSFER TO A THIRD PARTY.

- a. **Software Other Than Windows Anytime Upgrade.** The first user of the software may make a one time transfer of the software and this agreement, by transferring the original media, the certificate of authenticity, the product key and the proof of purchase directly to a third party. The first user must remove the software before transferring it separately from the computer. The first user may not retain any copies of the software.
- b. **Windows Anytime Upgrade Software.** You may transfer the software directly to a third party only with the licensed computer. You may not keep any copies of the software or any earlier edition.
- c. **Other Requirements.** Before any permitted transfer, the other party must agree that this agreement applies to the transfer and use of the software.

19. NOTICE ABOUT THE H.264/AVC VISUAL STANDARD, THE VC-1 VIDEO STANDARD, THE MPEG-4 VISUAL STANDARD AND THE MPEG-2 VIDEO STANDARD. This software includes H.264/AVC, VC-1, MPEG-4 Part 2, and MPEG-2 visual compression technology. MPEG LA, L.L.C. requires this notice: THIS PRODUCT IS LICENSED UNDER THE AVC, THE VC-1, THE MPEG-4 PART 2 VISUAL, AND THE MPEG-2 VIDEO PATENT PORTFOLIO LICENSES FOR THE PERSONAL AND NON-COMMERCIAL USE OF A CONSUMER TO (i) ENCODE VIDEO IN COMPLIANCE WITH THE ABOVE STANDARDS ("VIDEO STANDARDS") AND/OR (ii) DECODE AVC, VC-1, MPEG-4 PART 2 AND MPEG-2 VIDEO THAT WAS ENCODED BY A CONSUMER ENGAGED IN A PERSONAL AND NON-COMMERICAL ACTIVITY AND/OR WAS OBTAINED FROM A VIDEO PROVIDER LICENSED TO PROVIDE SUCH VIDEO. NO LICENSE IS GRANTED OR SHALL BE IMPLIED FOR ANY OTHER USE. ADDITIONAL INFORMATION MAY BE OBTAINED FROM MPEG LA, L.L.C. SEE WWW.MPEGLA.COM.

20. THIRD PARTY PROGRAMS. The software contains third party programs. The license terms with those programs apply to your use of them.

21. EXPORT RESTRICTIONS. The software is subject to United States export laws and regulations. You must comply with all domestic and international export laws and

- regulations that apply to the software. These laws include restrictions on destinations, end users and end use. For additional information, see www.microsoft.com/exporting.
22. **SUPPORT SERVICES.** Microsoft provides support services for the software as described at www.support.microsoft.com/common/international.aspx. If you are using software that is not properly licensed, you will not be entitled to receive support services.
23. **ENTIRE AGREEMENT.** This agreement (including the warranty below), additional terms (including any printed-paper license terms that accompany the software and may modify or replace some or all of these terms), and the terms for supplements, updates, Internet-based services and support services that you use, are the entire agreement for the software and support services.
24. **APPLICABLE LAW.**
- a. **United States.** If you acquired the software in the United States, Washington state law governs the interpretation of this agreement and applies to claims for breach of it, regardless of conflict of laws principles. The laws of the state where you live govern all other claims, including claims under state consumer protection laws, unfair competition laws, and in tort.
 - b. **Outside the United States.** If you acquired the software in any other country, the laws of that country apply.
25. **LEGAL EFFECT.** This agreement describes certain legal rights. You may have other rights under the laws of your state or country. You may also have rights with respect to the party from whom you acquired the software. This agreement does not change your rights under the laws of your state or country if the laws of your state or country do not permit it to do so.
26. **LIMITATION ON AND EXCLUSION OF DAMAGES.** You can recover from Microsoft and its suppliers only direct damages up to the amount you paid for the software. You cannot recover any other damages, including consequential, lost profits, special, indirect or incidental damages.

This limitation applies to

- anything related to the software, services, content (including code) on third party Internet sites, or third party programs; and
- claims for breach of contract, breach of warranty, guarantee or condition, strict liability, negligence, or other tort to the extent permitted by applicable law.

It also applies even if

- repair, replacement or a refund for the software does not fully compensate you for any losses; or
- Microsoft knew or should have known about the possibility of the damages.

Some states do not allow the exclusion or limitation of incidental or consequential damages, so the above limitation or exclusion may not apply to you. They also may not

apply to you because your country may not allow the exclusion or limitation of incidental, consequential or other damages.

LIMITED WARRANTY

- A. **LIMITED WARRANTY.** If you follow the instructions and the software is properly licensed, the software will perform substantially as described in the Microsoft materials that you receive in or with the software.
- B. **TERM OF WARRANTY; WARRANTY RECIPIENT; LENGTH OF ANY IMPLIED WARRANTIES.** **The limited warranty covers the software for one year after acquired by the first user. If you receive supplements, updates, or replacement software during that year, they will be covered for the remainder of the warranty or 30 days, whichever is longer.** If the first user transfers the software, the remainder of the warranty will apply to the recipient.

To the extent permitted by law, any implied warranties, guarantees or conditions last only during the term of the limited warranty. Some states do not allow limitations on how long an implied warranty lasts, so these limitations may not apply to you. They also might not apply to you because some countries may not allow limitations on how long an implied warranty, guarantee or condition lasts.

- C. **EXCLUSIONS FROM WARRANTY.** This warranty does not cover problems caused by your acts (or failures to act), the acts of others, or events beyond Microsoft's reasonable control.
- D. **REMEDY FOR BREACH OF WARRANTY.** Microsoft will repair or replace the software at no charge. If Microsoft cannot repair or replace it, Microsoft will refund the amount shown on your receipt for the software. It will also repair or replace supplements, updates and replacement software at no charge. If Microsoft cannot repair or replace them, it will refund the amount you paid for them, if any. You must uninstall the software and return any media and other associated materials to Microsoft with proof of purchase to obtain a refund. These are your only remedies for breach of the limited warranty.
- E. **CONSUMER RIGHTS NOT AFFECTED.** You may have additional consumer rights under your local laws, which this agreement cannot change.
- F. **WARRANTY PROCEDURES.** You need proof of purchase for warranty service.
1. **United States and Canada.** For warranty service or information about how to obtain a refund for software acquired in the United States and Canada, contact Microsoft at
 - (800) MICROSOFT;
 - Microsoft Customer Service and Support, One Microsoft Way, Redmond, WA 98052-6399; or
 - visit www.microsoft.com/info/nareturns.htm.

2. **Europe, Middle East and Africa.** If you acquired the software in Europe, the Middle East or Africa, Microsoft Ireland Operations Limited makes this limited warranty. To make a claim under this warranty, you should contact either
 - Microsoft Ireland Operations Limited, Customer Care Centre, Atrium Building Block B, Carmanhall Road, Sandyford Industrial Estate, Dublin 18, Ireland; or
 - the Microsoft affiliate serving your country (see www.microsoft.com/worldwide).
 3. **Outside United States, Canada, Europe, Middle East and Africa.** If you acquired the software outside the United States, Canada, Europe, the Middle East and Africa, contact the Microsoft affiliate serving your country (see www.microsoft.com/worldwide).
- G. **NO OTHER WARRANTIES.** The limited warranty is the only direct warranty from Microsoft. Microsoft gives no other express warranties, guarantees or conditions. Where allowed by your local laws, Microsoft excludes implied warranties of merchantability, fitness for a particular purpose and non-infringement. If your local laws give you any implied warranties, guarantees or conditions, despite this exclusion, your remedies are described in the Remedy for Breach of Warranty clause above, to the extent permitted by your local laws.
- H. **LIMITATION ON AND EXCLUSION OF DAMAGES FOR BREACH OF WARRANTY.** The Limitation on and Exclusion of Damages clause above applies to breaches of this limited warranty

This warranty gives you specific legal rights, and you may also have other rights which vary from state to state. You may also have other rights which vary from country to country.

Limited Warranty

All products manufactured by Seller are warranted to be free from defects in material and workmanship for a period of one (1) year, unless otherwise specified, from date of shipment and to conform to applicable specifications, drawings, blueprints and/or samples. Seller's sole obligation under these warranties shall be to issue credit, repair or replace any item or part thereof which is proved to be other than as warranted; no allowance shall be made for any labor charges of Buyer for replacement of parts, adjustment or repairs, or any other work, unless such charges are authorized in advance by Seller.

If Seller's products are claimed to be defective in material or workmanship or not to conform to specifications, drawings, blueprints and/or samples, Seller shall, upon prompt notice thereof, either examine the products where they are located or issue shipping instructions for return to Seller (transportation-charges prepaid by Buyer). In the event any of our products are proved to be other than as warranted, transportation costs (cheapest way) to and from Seller's plant, will be borne by Seller and reimbursement or credit will be made for amounts so expended by Buyer. Every such claim for breach of these warranties shall be deemed to be waived by Buyer unless made in writing within ten days from the date of discovery of the defect.

The above warranties shall not extend to any products or parts thereof which have been subjected to any misuse or neglect, damaged by accident, rendered defective by reason of improper installation or by the performance of repairs or alterations outside of our plant, and shall not apply to any goods or parts thereof furnished by Buyer or acquired from others at Buyer's request and/or to Buyer's specifications. Routine (regularly required) calibration is not covered under this limited warranty. In addition, Seller's warranties do not extend to the failure of tubes, transistors, fuses and batteries, or to other equipment and parts manufactured by others except to the extent of the original manufacturer's warranty to Seller.

The obligations under the foregoing warranties are limited to the precise terms thereof. These warranties provide exclusive remedies, expressly in lieu of all other remedies including claims for special or consequential damages. SELLER NEITHER MAKES NOR ASSUMES ANY OTHER WARRANTY WHATSOEVER, WHETHER EXPRESS, STATUTORY, OR IMPLIED, INCLUDING WARRANTIES OF MERCHANTABILITY AND FITNESS, AND NO PERSON IS AUTHORIZED TO ASSUME FOR SELLER ANY OBLIGATION OR LIABILITY NOT STRICTLY IN ACCORDANCE WITH THE FOREGOING.