



SIGNALHAWK™

MODEL SH-36S, SH-361S,  
SH-362, & SH-362S

OPERATING INSTRUCTIONS

©COPYRIGHT 2013 BY BIRD ELECTRONIC CORPORATION  
INSTRUCTION BOOK PART NUMBER 920-SH36-OPS REV. E

SIGNALHAWK IS A TRADEMARK OF BIRD ELECTRONIC CORPORATION  
ACTIVESYNC, MICROSOFT, AND WINDOWS ARE REGISTERED TRADEMARKS  
OF THE MICROSOFT CORPORATION



## Safety Precautions

---

The following are general safety precautions that are not necessarily related to any specific part or procedure, and do not necessarily appear elsewhere in this publication. These precautions must be thoroughly understood and apply to all phases of operation and maintenance.

### WARNING

#### **Keep Away From Live Circuits**

Operating Personnel must at all times observe general safety precautions. Do not replace components or make adjustments to the inside of the test equipment with the high voltage supply turned on. To avoid casualties, always remove power.

### WARNING

#### **Shock Hazard**

Do not attempt to remove the RF transmission line while RF power is present.

### WARNING

#### **Do Not Service Or Adjust Alone**

Under no circumstances should any person reach into an enclosure for the purpose of service or adjustment of equipment except in the presence of someone who is capable of rendering aid.

### WARNING

#### **Safety Earth Ground**

An uninterruptible earth safety ground must be supplied from the main power source to test instruments. Grounding one conductor of a two conductor power cable is not sufficient protection. Serious injury or death can occur if this grounding is not properly supplied.

### WARNING

#### **Resuscitation**

Personnel working with or near high voltages should be familiar with modern methods of resuscitation.

### WARNING

#### **Remove Power**

Observe general safety precautions. Do not open the instrument with the power on.

## Safety Symbols

---

### WARNING

Warning notes call attention to a procedure, which if not correctly performed, could result in personal injury.

### CAUTION

Caution notes call attention to a procedure, which if not correctly performed, could result in damage to the instrument.

**Note:** *Calls attention to supplemental information.*

## Warning Statements

---

The following safety warnings appear in the text where there is danger to operating and maintenance personnel, and are repeated here for emphasis.

### WARNING

When using the AC adapter, connect the AC plug only to a properly grounded receptacle. Serious injury or death can occur if not properly grounded.

See page 8.

### WARNING

Never attempt to connect or disconnect RF equipment from the transmission line while RF power is being applied.  
Leaking RF energy is a potential health hazard.

See page 115.

### WARNING

Care should be taken when handling objects with built up static electricity.  
Electrical shock may occur.

See page 131.

### WARNING

Care should be taken when handling batteries.  
Keep out of the reach of children.  
Do not heat or dispose of batteries in fire. May burst or release toxic materials.  
Avoid forced discharge.  
Do not short circuit.  
Restrict charging current and time to the recommended value.  
Do not solder the battery directly.  
Do not disassemble, apply excessive pressure, or deform.  
Avoid placing the battery in reverse polarity.  
Battery disposal method should be in accordance with local and state regulations.

See page 134.

## Caution Statements

---

The following equipment cautions appear in the text and are repeated here for emphasis.

**CAUTION**

Airflow is essential for proper unit operation. Do not obstruct the unit or soft case exhaust ports!

See page 9.

**CAUTION**

+20 dBm (100 mW) max. RF input for the Spectrum Analyzer and +22 dBm (160 mW) max. RF input for the Vector Network Analyzer.

Exceeding the maximum input will damage the SignalHawk. If unsure of power levels, measure the test connection with a power sensor before using the SignalHawk.

See page 9 and 113.

**CAUTION**

Vector Network Analyzer has a +22 dBm (160 mW) max. RF input. Exceeding the maximum input will damage the SignalHawk. If unsure of power levels, measure the test connection with a power sensor before using the SignalHawk.

See page 18.

**CAUTION**

Do not turn on a DC bias if the thru cable is attached from the VNA In to the VNA Out. This will damage the VNA input and destroy the unit.

See page 18, 20 and 55.

**CAUTION**

Center conductor cabling should be discharged prior to connecting. See “Discharging Static Electricity” on page 131 Any large electrostatic discharge or high power RF applied directly to the RF input or output will cause internal damage and void the warranty.

Power to any adjacent broadcast antennas should be shut down as well. If adjacent antenna broadcasts cannot be terminated, then adding sufficient external attenuation to the input of the instrument prior to connecting is recommended. Failure to do so could result in irreparable damage to the SignalHawk.

See page 18 and 21.

**CAUTION**

Spectrum Analyzer has a +20 dBm (100 mW) max. RF input. Exceeding the maximum input will damage the SignalHawk. If unsure of power levels, measure the test connection with a power sensor before using the SignalHawk.

See page 21.

**CAUTION**

SignalHawk test ports are not used for power measurement. Always use an external sensor!

See page 112.

**CAUTION**

Always turn off the SignalHawk before connecting or disconnecting a sensor.

See page 112.

**CAUTION**

Harsh or abrasive detergents, and some solvents, can damage the display unit and labels.

See page 131.

## **Safety Statements**

---

### **USAGE**

ANY USE OF THIS INSTRUMENT IN A MANNER NOT SPECIFIED BY THE MANUFACTURER MAY IMPAIR THE INSTRUMENT'S SAFETY PROTECTION.

### **USO**

EL USO DE ESTE INSTRUMENTO DE MANERA NO ESPECIFICADA POR EL FABRICANTE, PUEDE ANULAR LA PROTECCIÓN DE SEGURIDAD DEL INSTRUMENTO.

### **BENUTZUNG**

WIRD DAS GERÄT AUF ANDERE WEISE VERWENDET ALS VOM HERSTELLER BESCHRIEBEN, KANN DIE GERÄTESICHERHEIT BEEINTRÄCHTIGT WERDEN.

### **UTILISATION**

TOUTE UTILISATION DE CET INSTRUMENT QUI N'EST PAS EXPLICITEMENT PRÉVUE PAR LE FABRICANT PEUT ENDOMMAGER LE DISPOSITIF DE PROTECTION DE L'INSTRUMENT.

### **IMPIEGO**

QUALORA QUESTO STRUMENTO VENISSE UTILIZZATO IN MODO DIVERSO DA COME SPECIFICATO DAL PRODUTTORE LA PROZIONE DI SICUREZZA POTREBBE VENIRNE COMPROMESSA.

## **SERVICE**

SERVICING INSTRUCTIONS ARE FOR USE BY SERVICE - TRAINED PERSONNEL ONLY. TO AVOID DANGEROUS ELECTRIC SHOCK, DO NOT PERFORM ANY SERVICING UNLESS QUALIFIED TO DO SO.

## **SERVICIO**

LAS INSTRUCCIONES DE SERVICIO SON PARA USO EXCLUSIVO DEL PERSONAL DE SERVICIO CAPACITADO. PARA EVITAR EL PELIGRO DE DESCARGAS ELÉCTRICAS, NO REALICE NINGÚN SERVICIO A MENOS QUE ESTÉ CAPACITADO PARA HACERLO.

## **WARTUNG**

ANWEISUNGEN FÜR DIE WARTUNG DES GERÄTES GELTEN NUR FÜR GESCHULTES FACHPERSONAL.

ZUR VERMEIDUNG GEFÄHRLICHE, ELEKTRISCHE SCHOCKS, SIND WARTUNGSARBEITEN AUSSCHLIEßLICH VON QUALIFIZIERTEM SERVICEPERSONAL DURCHZUFÜHREN.

## **ENTRETIEN**

L'EMPLOI DES INSTRUCTIONS D'ENTRETIEN DOIT ÊTRE RÉSERVÉ AU PERSONNEL FORMÉ AUX OPÉRATIONS D'ENTRETIEN. POUR PRÉVENIR UN CHOC ÉLECTRIQUE DANGEREUX, NE PAS EFFECTUER D'ENTRETIEN SI L'ON N'A PAS ÉTÉ QUALIFIÉ POUR CE FAIRE.

## **ASSISTENZA TECNICA**

LE ISTRUZIONI RELATIVE ALL'ASSISTENZA SONO PREVISTE ESCLUSIVAMENTE PER IL PERSONALE OPPORTUNAMENTE ADDESTRATO. PER EVITARE PERICOLOSE SCOSSE ELETTRICHE NON EFFETTUARE ALCUNA RIPARAZIONE A MENO CHE QUALIFICATI A FARLA.



**UNITS ARE EQUIPPED WITH RECHARGEABLE BATTERIES.**

THESE ARE TO BE REPLACED BY AUTHORIZED SERVICE PERSONNEL ONLY!!!

**LAS UNIDADES VIENEN EQUIPADAS CON BATERIAS  
RECARGABLES.**

¡¡¡Y SOLAMENTE EL PERSONAL DE SERVICIO AUTORIZADO  
PUEDE REEMPLAZARLAS!!!

**GERÄTE SIND MIT WIEDER AUFLADBAREN BATTERIEN  
BESTÜCKT.**

BATTERIEN SIND NUR VON QUALIFIZIERTEM SERVICE  
PERSONAL AUSZUWECHSELN!!!

**CES DISPOSITIFS SONT ÉQUIPÉS DE BATTERIES  
RECHARGEABLES.**

SEUL LE PERSONNEL D'ENTRETIEN AUTORISÉ EST HABILITÉ  
À LES REMPLACER!

**LE UNITÀ SONO DOTATE DI BATTERIE RICARICABILI,**

CHE DEVONO DA COME SPECIFICATO DAL PRODUTTORE LA  
PROTEZIONE DI SICUREZZA POTREBBE VENIRNE  
COMPROMESSA.

## About This Manual

---

This manual covers the operating and maintenance instructions for the following models:

SH-36S	SH-361S
SH-362	SH-362S

## Changes to this Manual

---

We have made every effort to ensure this manual is accurate. If you discover any errors, or if you have suggestions for improving this manual, please send your comments to our Solon, Ohio factory. This manual may be periodically updated. When inquiring about updates to this manual refer to the part number and revision on the title page.

## Literature Contents

---

### Start-up Instructions

---

The Start-up Instructions contains minimum operational steps and the order they should be performed. Use this manual for reference or if further explanation of any step is required.

### Operations Manuals

---

#### Chapter Layout

**Introduction** — Describes the features of the Bird SignalHawk, lists equipment supplied and optional equipment, and provides power-up instructions.

**Vector Network Analysis Settings** — Describes how to connect SignalHawk to the user's system, describes the vector network analyzer measurements, and provides quick start steps for each measurement.

**Vector Network Analysis Measurements** — Describes the power measurement feature, lists compatible power sensors, describes how to connect SignalHawk to the user's system, and provides quick start steps to make power measurements.

**Spectrum Analyzer Settings** — Describes how to connect SignalHawk to the user's system, describes the spectrum analyzer measurements, and provides quick start steps for each measurement.

**Spectrum Analyzer Measurements** — Describes the power measurement feature, lists compatible power sensors, describes how to connect SignalHawk to the user's system, and provides quick start steps to make power measurements.

**PC Tool** — Describes how to use the SignalHawk's PC Tool function and how to transfer readings from the SignalHawk to the computer and back again.

**Power Measurements** — Describes the Menu key and Soft key functions for setting up power measurements.

**Utilities** — Describes built-in instrument utility features and how to use them.

**Maintenance** — Lists routine maintenance tasks as well as troubleshooting for common problems. Specifications and parts information are also included.



---

# TABLE OF CONTENTS

<b>Safety Precautions</b> .....	<b>i</b>
Safety Symbols .....	ii
Warning Statements .....	ii
Caution Statements .....	iii
Safety Statements .....	v
<b>About This Manual</b> .....	<b>viii</b>
Changes to this Manual .....	viii
Literature Contents .....	viii
Start-up Instructions .....	viii
Operations Manuals .....	viii
Chapter Layout .....	viii
<b>Chapter 1 Introduction</b> .....	<b>1</b>
Items Supplied .....	2
Looking at the SignalHawk .....	3
Power Supply .....	8
Internal Battery .....	8
Power Adapters .....	8
Getting Started with the SignalHawk .....	9
Start Menu, Menu Keys .....	9
VN Analysis .....	9
Spec Analysis Menu Key .....	9
Power Meter Menu Key .....	9
Utilities Menu Key .....	9
Help Menu Key .....	10
VNA Help - .....	10
Spectrum Analyzer Help - .....	10
Power Meter Help - .....	10
Custom Help - .....	10
Back... - .....	10
Setup Menu .....	13
Quick Save Setup .....	13
Label & Save Setup .....	14
Recall Setup .....	14
Recall Default Setup .....	14
Manage Setup Files .....	14
Copy Setup to USB Drive .....	15
Copy All Setups to USB Drive .....	15
Copy Setup from USB Drive .....	15
Delete .....	15

- Delete All Setups . . . . . 15
- View Setup . . . . . 16
  - Recall Setup . . . . . 16
  - Delete . . . . . 16
  - Top of the List . . . . . 16
  - Bottom of the List . . . . . 16
  - View Next Setup . . . . . 16
  - View Previous Setup . . . . . 16
- Looking at the Screen . . . . . 17
- Vector Network Analyzer Quick Start . . . . . 18
- Spectrum Analyzer Quick Start . . . . . 21
- Global Positioning System (GPS) . . . . . 22
  - Adding Custom Locations . . . . . 22

**Chapter 2 Vector Network Analyzer Settings . . . . . 23**

- Core Soft Key Functions . . . . . 23
- Freq & Span Menu . . . . . 24
  - Start / Stop Freq and Center / Span . . . . . 25
  - Wheel Step . . . . . 25
  - Full Span . . . . . 25
  - Freq List . . . . . 25
    - Adding Custom Frequencies . . . . . 26
- Calibrate Menu . . . . . 27
- Ampt & Trace Menu . . . . . 29
  - Autoscale . . . . . 29
  - Max Level . . . . . 29
  - Min Level . . . . . 29
  - Offset . . . . . 29
  - Units . . . . . 30
    - VSWR . . . . . 30
    - Return Loss . . . . . 30
    - rho . . . . . 30
    - Match % . . . . . 30
    - Reflection % . . . . . 30
  - Pwr Out . . . . . 30
  - Sweep . . . . . 30
    - Cont/Single . . . . . 30
    - Data Points . . . . . 30
    - Interference Immunity . . . . . 31
    - IFBW . . . . . 31
  - Trace . . . . . 31
    - Clear Write . . . . . 31
    - Max Hold . . . . . 31
    - Average . . . . . 31

Average Readings	31
Reset Average	31
Water Fall	32
Mark & Limit Menu	33
Select Marker	33
Marker On / Off	33
Marker to Max Peak	33
Markers to Peak/Valley	33
Markers Detect	33
Threshold Offset	34
Marker to Max Peak or Marker to Min Valley	34
Marker to Next Peak Left or Marker to Next Valley Left	34
Marker to Next Peak Right or Marker to Next Valley Right	34
All Markers to Max Peaks or All Markers to Min Valleys	34
All Markers Off	34
Marker Delta	34
Marker Display	34
Marker Type	34
All Markers Type to Icon	34
All Markers Type to Line	34
Marker Display	34
Marker More	35
RSSI (Received Signal Strength Indicator)	35
Volume	35
Marker Freq to Center	35
Limit Lines	35
Limit Upper/Lower	35
Limit On/Off	35
Limit Alarm On/Off	35
File & Help Menu	36
Quick Save	36
Label & Save Trace	37
Log Traces	37
Recall Trace	37
Recall Trace	37
Recall & Compare	37
Clear Recalled Trace	37
Manage Trace Files	38
Screen Image	38
Quick Save Screen	38
Full Screen	38
Print Screen Image	38
Manage Image Files	39

Copy Image to USB Drive -	39
Copy All Images to USB Drive -	39
Copy Image from USB Drive -	39
Top of List -	39
Bottom of List -	39
Delete Trace -	39
Delete All Traces -	39
Utility	39
Help	39
<b>Chapter 3 Vector Network Analyzer Measurements</b>	<b>41</b>
Match Measurement	42
Equations	42
VSWR	42
Return Loss	42
Reflection Coefficient	42
Match efficiency %	42
Reflection %	42
Distance to Fault (DTF) Measurement	46
Start Distance	47
Stop Distance	48
Data Points	48
Distance Units	48
Cable	48
Cable List	49
Velocity	49
Loss	50
Smooth	50
DTF Wizard	51
Vp (Velocity)	51
Loss	52
Estimated Cable	52
Center Frequency	53
Preferred Resolution	53
Cable Loss (1 Port) Measurement	54
Gain & Loss (2 Port) Measurement	55
Bias Tee Voltage	55
Bias Tee	55
<b>Chapter 4 Spectrum Analyzer Settings</b>	<b>57</b>
Core Soft Key Functions	57
Freq & Span Menu	58
Start / Stop Freq and Center / Span	59
Wheel Step	59



Full Span .....	59
Freq List .....	59
Adding Custom Frequencies .....	60
BW & Sweep Menu .....	61
Resolution BW Mode .....	62
Resolution BW .....	62
Video BW Mode .....	62
Video BW .....	63
Span/RBW .....	63
RBW / VBW .....	63
Detection Mode .....	64
+ Peak Detection .....	64
- Peak Detection .....	64
Sample Detection .....	64
Average Power .....	64
Sweep More .....	65
Continuous .....	65
Free Rep - .....	65
Single .....	66
Trigger - .....	66
Arm Trigger - .....	66
External Trigger .....	66
External - Low Level / High Level / Rise Edge / Fall Edge / Either Edge .....	66
Gate Delay .....	66
Video .....	68
External - Low Level / High Level / Rise Edge / Fall Edge / Either Edge .....	69
Gate Delay .....	69
Ampt & Trace Menu .....	70
Autoscale .....	70
Reference .....	70
Scale .....	70
Attenuation .....	70
Preamp .....	71
Offset .....	71
Units .....	71
Trace .....	72
Clear Write .....	72
Max Hold .....	72
Min Hold .....	72
Average .....	72
Average Readings .....	72
Reset Average .....	72

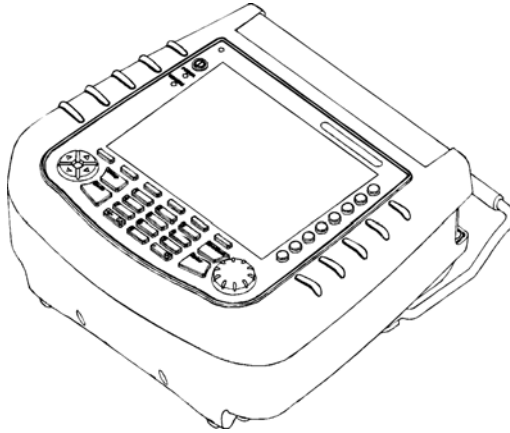
Water Fall	72
Mark & Limit Menu	73
Select Marker	73
Marker On / Off	73
Marker to Max Peak	73
Markers to Peak/Valley	73
Markers Detect	73
Threshold Offset	73
Marker to Max Peak or Marker to Min Valley	74
Marker to Next Peak Left or Marker to Next Valley Left	74
Marker to Next Peak Right or Marker to Next Valley Right	74
All Markers to Max Peaks or All Markers to Min Valleys	74
All Markers Off	74
Marker Delta	74
Marker Display	74
Marker Type	74
All Markers Type to Icon	74
All Markers Type to Line	74
Marker Display	74
Marker More	74
RSSI (Received Signal Strength Indicator)	75
Volume	75
Marker Freq to Center	75
Center Freq to Marker	75
Ref Level Ampt to Marker	75
Frequency Counter	75
Limit Lines	75
Limit Upper/Lower	75
Limit On/Off	75
Limit Alarm On/Off	75
Select Line/Mask	75
Freq Lock -	76
EM to Max Peak -	76
File & Help Menu	77
Quick Save	77
Label & Save Trace	78
Log Traces	78
Recall Trace	78
Recall Trace	78
Recall & Compare	78
Clear Recalled Trace	78
Manage Trace Files	79
Copy Trace to USB Drive	79

Copy All Traces to USB Drive . . . . .	79
Copy Trace from USB Drive . . . . .	79
Delete Trace . . . . .	80
Delete All Traces . . . . .	80
Screen Image . . . . .	80
Quick Save Screen . . . . .	80
Full Screen . . . . .	80
Print Screen Image . . . . .	80
Manage Image Files . . . . .	81
Copy Image to USB Drive - . . . . .	81
Copy All Images to USB Drive - . . . . .	81
Copy Image from USB Drive - . . . . .	81
Top of List - . . . . .	81
Bottom of List - . . . . .	81
Delete Trace - . . . . .	81
Delete All Traces - . . . . .	81
Utility . . . . .	81
Help . . . . .	81
<b>Chapter 5 Spectrum Analyzer Measurements . . . . .</b>	<b>83</b>
Spectrum Analysis Measurement . . . . .	84
Occupied Bandwidth Measurement . . . . .	85
Threshold Modes . . . . .	85
% . . . . .	85
dBc . . . . .	85
Setting Occupied Bandwidth . . . . .	85
Channel Power Measurement . . . . .	87
Setting Channel Power . . . . .	87
Adjacent Channel Power Measurement . . . . .	89
Time Domain (Zero Span) . . . . .	91
Field Strength Measurement . . . . .	92
Received Signal Strength Indicator (RSSI) . . . . .	92
Demodulate Signal . . . . .	93
Carrier-to-Interference Ratio . . . . .	94
Out-of-Band and In-Band, Out-of-Channel Spurious . . . . .	96
<b>Chapter 6 PC Tool . . . . .</b>	<b>97</b>
Computer Requirements . . . . .	97
Installing Windows 7 Drivers for the BTG Signal Hawk . . . . .	97
Downloading and Installing Software . . . . .	100
Installing the SignalHawk USB Drivers 1 . . . . .	00
Installing the PC Tool Software . . . . .	101
Menu Bar . . . . .	101
File . . . . .	101

Edit .....	101
View .....	101
Tools .....	101
Measurements .....	102
Communicate .....	102
Tool Bar .....	102
Save .....	102
Open .....	102
Cut .....	103
Copy .....	103
Paste .....	103
Delete Trace .....	103
Return to Normal Mode .....	103
Zoom In .....	103
Zoom Out .....	103
Autoscale Graph .....	103
Add Markers .....	103
Add to Upper Limit Line .....	103
Add to Lower Limit Line .....	104
Delete Markers or Limit Lines .....	104
Option Dialog Box .....	104
Measurement Types .....	104
VNA Tool Bar .....	104
Match .....	104
Distance to Fault .....	104
Cable .....	105
Smith .....	105
Options Dialog Box .....	105
DTF Wizard .....	105
Options Dialog Box (View>Options) .....	105
Scale Tab .....	105
Units Tab .....	106
Markers Tab .....	106
Limits 1 Tab .....	107
Limits 2 Tab .....	107
Labels Tab .....	108
GPS .....	109
<b>Chapter 7 Power Measurements .....</b>	<b>111</b>
Quick Setup - Configure Sensor and Instrument .....	112
Connecting a Sensor .....	112
Looking at the Screen .....	114
Directional Power Sensor Measurements .....	115
Terminating Power Sensor Measurements .....	115

Wideband Power Sensor Measurements	115
Filter: Full -	115
Duty Cycle -	116
Manual Duty Cycle -	116
CCDF Limit (Complimentary Cumulative Distribution Function) -	116
Range Select -	116
Menu Keys and Associated Soft Key Functions	116
Zero	116
Type	116
Units	118
Power: Watts	118
Power: dBm	118
Match: VSWR	118
Match: Return Loss dB	118
Match: Rho	119
Match Efficiency %	119
Forward Average	119
Reflected Average	119
Match	119
Forward Peak	119
Forward Burst	119
Crest Factor	119
CCDF (Complimentary Cumulative Distribution Function)	120
Configure	120
Quick Setup - Zero a Sensor	122
File & Help	122
Quick Save Data	123
Log: On / Off	124
<b>Chapter 8 Utilities</b>	<b>125</b>
Utilities	125
Utility Main Menu	126
Version Info	126
VNA Help	126
Spectrum Analyzer Help	126
Power Meter Help	126
Custom Help	126
Installing Custom Help Files	126
Date Time	127
Select Language	127
Backlight Control	128
Exit to Windows	129
Customizing SignalHawk Content	129

<b>Chapter 9 Maintenance</b> .....	<b>131</b>
Cleaning .....	131
Discharging Static Electricity .....	131
Charging the Battery .....	131
Upgrading the Software/Firmware .....	131
PC Procedure .....	132
SignalHawk Procedure .....	133
Replacing the Battery .....	134
Troubleshooting .....	136
For All Models .....	136
For Vector Network Analyzer Only .....	136
For Spectrum Analyzer Only .....	137
Specifications .....	137
SignalHawk Models .....	137
For Spectrum Analyzer Models SH-362S, SH-361S and SH-36S 1. ....	37
Chart I - Distortion & DANL .....	139
For Vector Network Analyzer (Models SH-362S, SH-362, & SH-361S Only) .....	139
Chart II - Return Loss Uncertainty, 1.6MHz to 3.6GHz .....	142
Chart III - Insertion Loss/Gain Uncertainty, 1.6 MHz to 3.6 GHz .....	142
Power Sensors Supported .....	147
Parts List .....	149
Optional Accessories .....	150
General .....	150
Spectrum Analyzer .....	150
VNA .....	150
External Power Sensors .....	151
Test Cables and Adapters .....	153
ROHS .....	154
<b>Appendix 1 Menu Maps</b> .....	<b>155</b>
Vector Network Analyzer (VNA) Menu Maps .....	155
Spectrum Analyzer Menu Maps 1. ....	64
Power Meter Menu Maps .....	171
Start Menu, Help Menu Maps .....	179
Start Menu, Utilities Menu Map .....	180
Setup Function Menu Maps .....	182
<b>Limited Warranty</b> .....	<b>183</b>



The SignalHawk is a multifunction test instrument for use in the installation and maintenance of Radio Frequency (RF) and wireless systems. The model number is identified on the unit and also on the display screen at the end of the power-on sequence.

- Models SH-362S:
  - Spectrum Analyzer 100 kHz - 3.6 GHz
  - 2 Port Vector Network Analyzer 1.6 MHz - 3.6 GHz
- Models SH-361S:
  - Spectrum Analyzer 100 kHz - 3.6 GHz
  - 1 Port Vector Network Analyzer 1.6 MHz - 3.6 GHz
- Models SH-362:
  - 2 Port Vector Network Analyzer 1.6 MHz - 3.6 GHz
- Models SH-36S:
  - Spectrum Analyzer only 100 kHz - 3.6 GHz.

The SignalHawk can control and display readings from Bird power sensors 5010B, 5011, 5012B, 5016B, 5017B, 5018B and 5019B.

The firmware installed on the SignalHawk is updated on a regular basis. The operator's manual covers the most recent upgrade to the firmware up to the date listed on the manual. Not all SignalHawk models have the current revision of the firmware. Please upgrade the firmware to obtain the most current revision. See "Upgrading the Software/Firmware" on page 131.

# Items Supplied

Figure 1 Hardware and Software Supplied

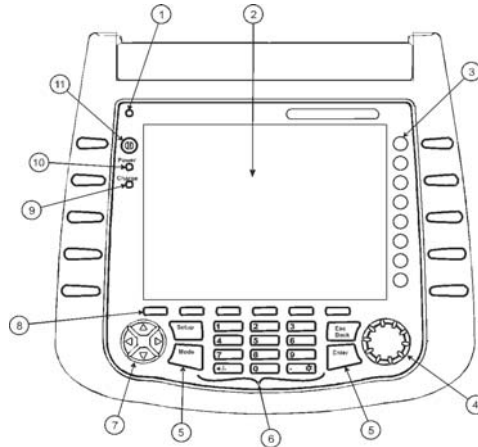


Item	Description
1	SignalHawk, with Li-Ion battery pack installed. Stand on back can be rotated to four positions, and can be used as a carry handle.
2	Cigarette lighter adapter
3	USB cable
4	USB memory drive
5	AC power adapter with detachable cord
6	CD with manuals and PCTool software. 7002A210 - SignalHawk PC Tool Software
7	Soft carry case, featuring connector weather covers, carry handles, detachable accessory pouch, and detachable shoulder strap
---	Not shown are the Start-up Instructions, Operations Manual CD, and rain flap (can be installed on unit when not using the soft carry case).



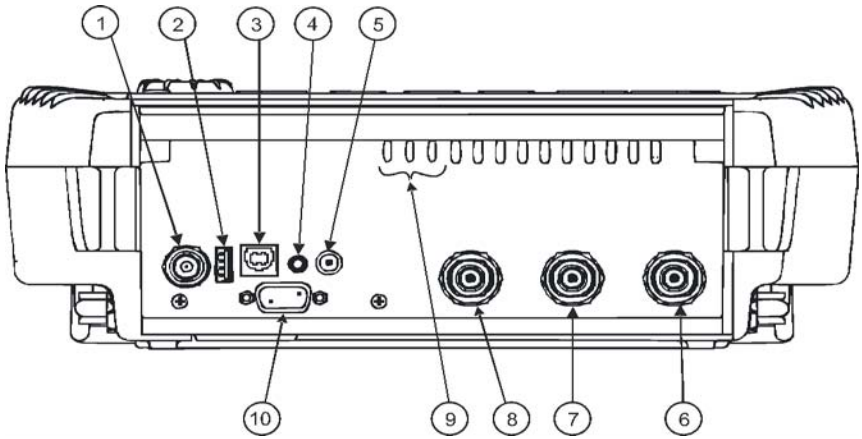
# Looking at the SignalHawk

Figure 2 Controls and Indicators



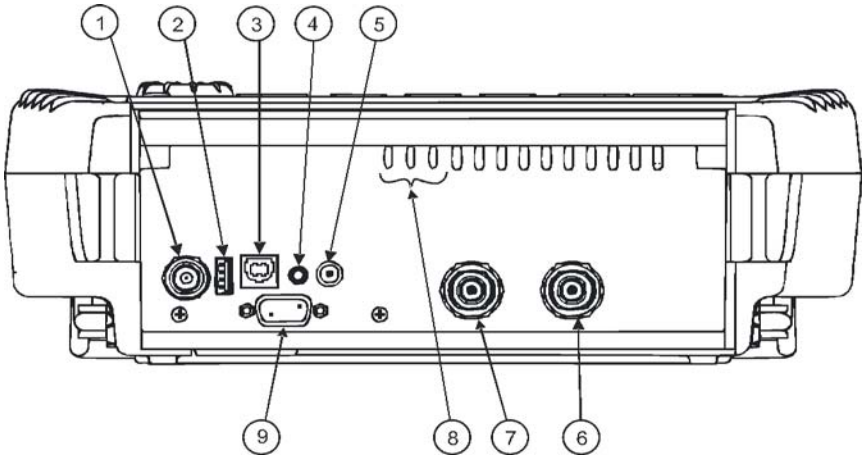
Item	Description
1	Light sensor. Do not cover when using backlight in automatic mode.
2	Display screen
3	Eight blue “soft keys.” Press to activate the function or option displayed in the label next to it on the display. Label and key function will change depending on the active menu.
4	Thumbwheel, used to move in lists, choose options, and increase or decrease numbers.
5	Green “Special” keys. Setup, Mode, Esc/Back and Enter. <b>Setup:</b> Go to the Setup Menu. In setup, pre-defined measurement parameters can be selected and loaded. Factory setups cannot be changed. User-defined setups can be created, changed, and deleted. <b>Mode:</b> Go to the Start Menu. <b>Esc/Back:</b> Cancel data entry or return to the previous screen. <b>Enter:</b> Select an item or complete entering a number.
6	Numeric keypad, used to enter values
7	Arrow keys (up, down, left, right). Used to move in lists, choose options, and increase or decrease numbers.
8	Six yellow “menu keys.” A label is displayed just above each key on the display. Press to change the soft keys to the functions associated with this menu.
9	Amber “Charge” LED Off when not connected to external AC On continuously when battery is fully charged Blinks slowly when battery is charging Blinks rapidly when a battery problem exists <b>Note:</b> <i>This usually occurs when the battery cable has become dislodged and will resolve itself with no intervention. If it persists, then service is needed.</i>
10	Green “Power” LED On while the unit is turned on.
11	Power ON/OFF switch

**Figure 3 Connector Panel - SH-362S**



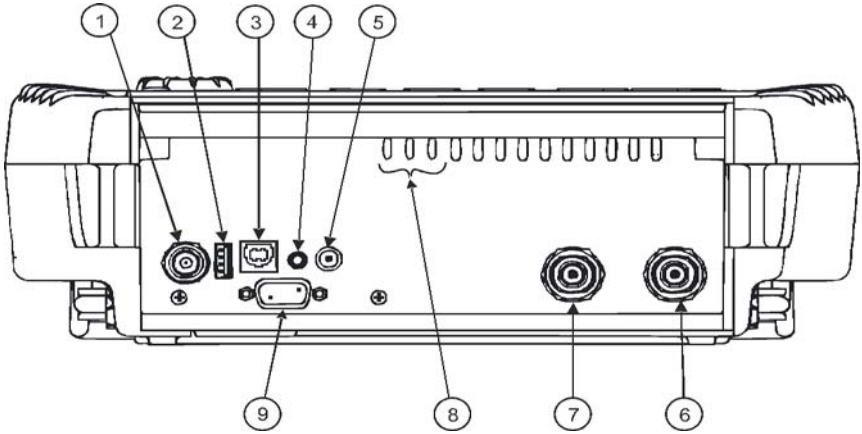
Item	Description
1	BNC(F) external trigger input, 5V TTL
2	USB Type A for USB drive and accessories
3	USB Type B for PC connection
4	3.5mm mini-headphone jack
5	2.5mm DC jack for external power supplies
6	VNA Thru Port
7	VNA Test Port
8	Spectrum Analyzer Port, N(F) RF input, +20 dBm max.
9	Internal Speaker and air inlet ports. There is also an air exhaust on the back of the unit. <b>Note:</b> Do not block the inlet or exhaust.
10	RS-232 DB-9(F) connector for power sensors.

**Figure 4 Connector Panel - SH-361S**



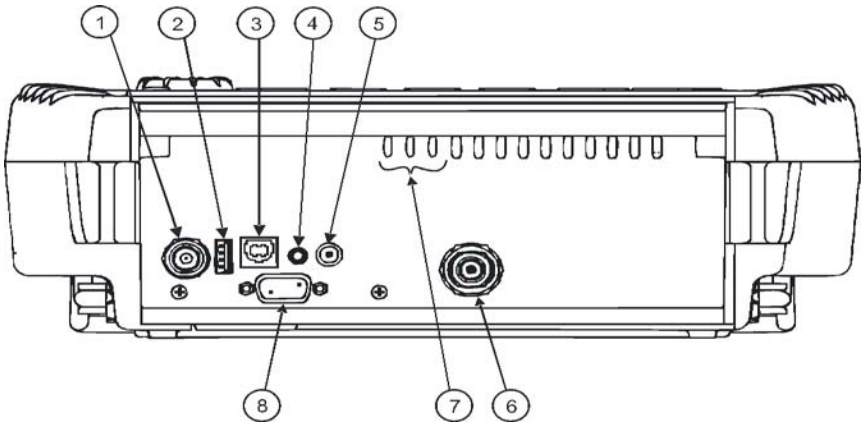
Item	Description
1	BNC(F) external trigger input, 5V TTL
2	USB Type A for USB drive and accessories
3	USB Type B for PC connection
4	3.5mm mini-headphone jack
5	2.5mm DC jack for external power supplies
6	VNA Test Port
7	Spectrum Analyzer Port, N(F) RF input, +20 dBm max.
8	Internal Speaker and air inlet ports. There is also an air exhaust on the back of the unit. <b>Note:</b> <i>Do not block the inlet or exhaust.</i>
9	RS-232 DB-9(F) connector for power sensors

**Figure 5 Connector Panel - SH-362**



Item	Description
1	BNC(F) external trigger input, 5V TTL
2	USB Type A for USB drive and accessories
3	USB Type B for PC connection
4	3.5mm mini-headphone jack
5	2.5mm DC jack for external power supplies
6	VNA Thru Port
7	VNA Test Port
8	Internal Speaker and air inlet ports. There is also an air exhaust on the back of the unit. <b>Note:</b> <i>Do not block the inlet or exhaust.</i>
9	RS-232 DB-9(F) connector for power sensors

**Figure 6 Connector Panel - SH-36S**



Item	Description
1	BNC(F) external trigger input, 5V TTL
2	USB Type A for USB drive and accessories
3	USB Type B for PC connection
4	3.5mm mini-headphone jack
5	2.5mm DC jack for external power supplies
6	Spectrum Analyzer Port, N(F) RF input, +20 dBm max.
7	Internal Speaker and air inlet ports. There is also an air exhaust on the back of the unit. <b>Note:</b> <i>Do not block the inlet or exhaust.</i>
8	RS-232 DB-9(F) connector for power sensors

## Power Supply

---

### Internal Battery

---

The SignalHawk has an internal, rechargeable, lithium-ion battery pack that will operate the unit for a minimum of 3 hours of continuous use. Recharging time, from a full discharge, is approximately 4 hours. When running the unit on battery power, the percentage of battery life remaining is displayed in the lower right corner of the screen.

**Note:** *When the unit is shipped from the factory, the battery may not be fully charged. Use an AC adapter when the unit is operated for the first time.*

### Power Adapters

---

**WARNING**

When using the AC adapter, connect the AC plug only to a properly grounded receptacle. Serious injury or death can occur if not properly grounded.

The SignalHawk can be operated using the supplied AC adapter or a 12V automobile cigarette lighter adapter. Using these adapters will also charge the internal battery.

**Note:** *When using the supplied car charging adapter, a minimum voltage of 11.5V is required. To ensure complete charging, at least 13V must be present at the DC input.*

# Getting Started with the SignalHawk

---

## CAUTION

Airflow is essential for proper unit operation. Do not obstruct the unit or soft case exhaust ports!

## CAUTION

+20 dBm (100 mW) max. RF input for the Spectrum Analyzer and +22 dBm (160 mW) max. RF input for the Vector Network Analyzer.  
Exceeding the maximum input will damage the SignalHawk. If unsure of power levels, measure the test connection with a power sensor before using the SignalHawk.

Press the Power button to turn on the unit. The screen will show the Bird Technologies Group logo and then boot the SignalHawk software. During boot up, the unit will perform an automatic self-test. After about 30 seconds, the unit will display the Start Menu (see Figure 7 or Figure 8) and be ready for use.

## Start Menu, Menu Keys

---

Menu keys are the six rectangular yellow keys located below the display screen. Each menu key corresponds to an item on the menu bar displayed on the screen. When using a menu list, use the thumbwheel or the up- and down-arrow keys to move the highlight bar through the list. Use the left- and right-arrow keys to move to a different list box.

### VN Analysis

Allows a user to select any of the Vector Network Analyzer measurement modes.

### Spec Analysis Menu Key

Allows a user to select any of the Spectrum Analyzer measurement modes.

### Power Meter Menu Key

Allows a user to select any of the Power Meter measurement modes.

### Utilities Menu Key

Display the Utility Menu main screen. The Utility Menu provides information about the instrument software, amount of available memory, battery charge status, system date and time, and how to contact Bird Technologies Group.

## **Help Menu Key**

Displays the Help soft keys but does not exit the current screen. Press the Back... soft key to exit the Help Menu.

**VNA Help** - Procedures and specifications for the Vector Network Analyzer feature of the SignalHawk.

**Spectrum Analyzer Help** - Procedures and specifications for the Spectrum Analyzer feature of the SignalHawk.

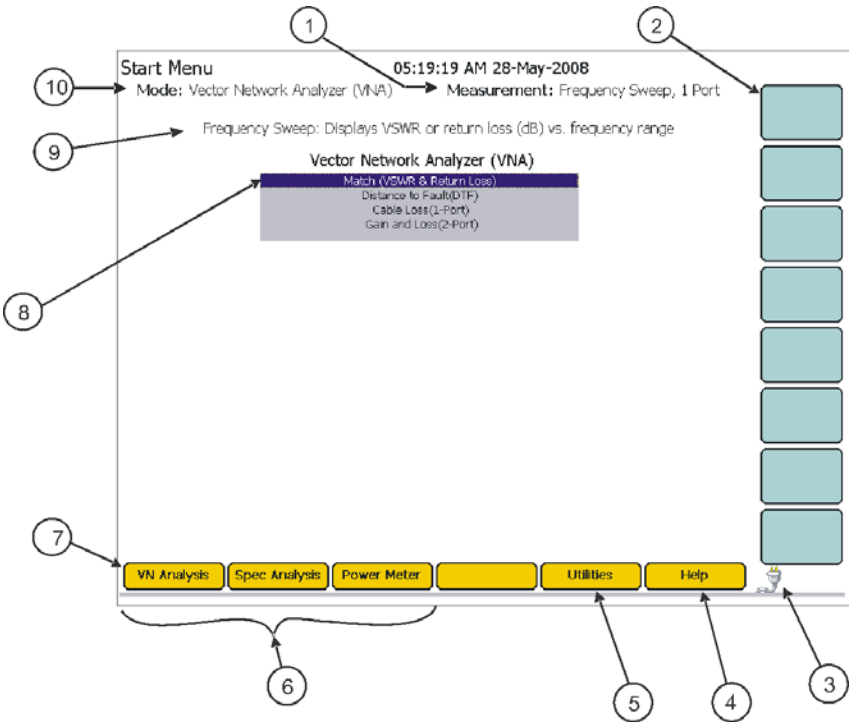
**Power Meter Help** - Procedures and specifications for the Power Meter feature of the SignalHawk.

**Custom Help** - See "Custom Help" on page 126.

**Back...** - Returns to the features of the previous menu.

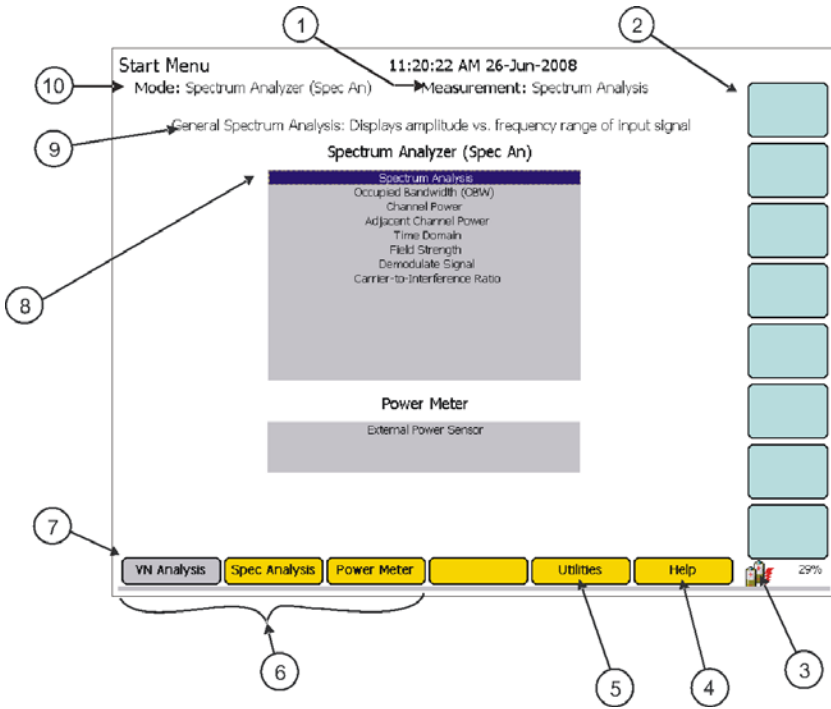


**Figure 7 SignalHawk Start Menu - Vector Network Analyzer**



Item	Description
1	Name of measurement being used
2	Soft keys
3	Power source icon (AC, battery, or battery charging)
4	Go to the Help menu. See "Help Menu Key" on page 10.
5	Go to the Utilities menu. See "Utilities" on page 125.
6	Measurement mode lists
7	Menu keys
8	Selected measurement (highlighted)
9	Name and brief description of highlighted measurement
10	Current active operating mode

**Figure 8 SignalHawk Start Menu - Spectrum Analyzer**



Item	Description
1	Name of measurement being used
2	Soft key labels
3	Power source icon (AC, battery, or battery charging)
4	Go to the Help menu. See "Help Menu Key" on page 10.
5	Go to the Utilities menu. See Chapter 8, page 125.
6	Measurement mode lists.
7	Menu key labels
8	Selected measurement (highlighted)
9	Name and brief description of highlighted measurement
10	Current active operating mode

## Setup Menu

The Setup Menu allows access to saved setups and settings used previously on the SignalHawk. Press the Setup button to access the menu.

**Figure 9 Setup Menu**

Setup Menu 04:59:18 AM 26-Aug-2009

Mode: Vector Network Analyzer (VNA) Measurement: Frequency Sweep, 1 Port  
Setup: 334.290760-3.599999999 GHz  
Frequency Sweep: Displays VSWR or return loss (dB) vs. frequency range

Setup	Freq	Mode	Time/Date	Type
Backup SA	45.000080-5...	Spec Analysis	12:49PM/25...	C
Backup VNA	334.290760-...	VN Analysis	12:49PM/25...	C
Factory SA	100.000000-...	Spec Analysis	10:15AM/24...	C
Factory VNA	325.000000-...	VN Analysis	11:46AM/15...	C
Loss (Less than ...	325.000000-...	VN Analysis	2:25PM/27-J...	C

Quick Save Setup  
Label & Save Setup  
Recall Setup  
Recall Default Setup  
Manage Setup Files  
View Setup  
Back...

Help

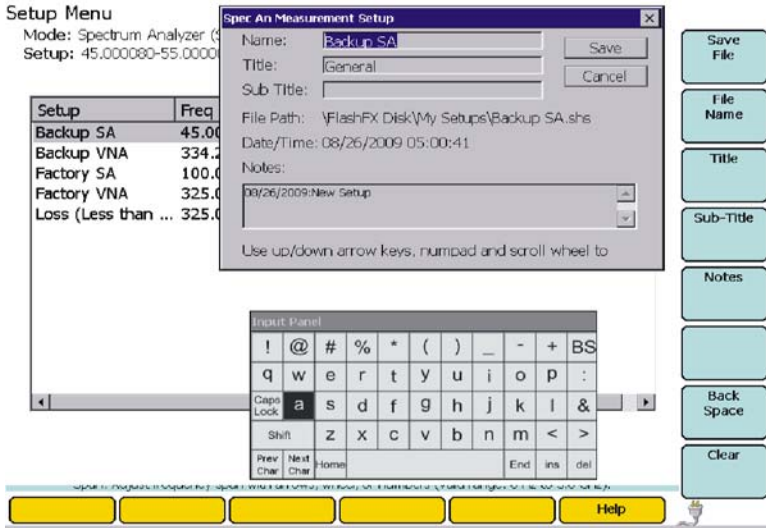
## Quick Save Setup

The saved settings are stored as a file in the internal flash drive of the instrument. Each quick save is stored in a separate file that is named using the date-time file naming format *GeneralSA(MM-DD-hh-mm-ss).shs* where YYYY is the year, the first MM is the month, DD is the day, hh is the hour, the second mm is the minute, and ss is the second of the time when the file was saved.

## Label & Save Setup

---

Figure 10 Setup Menu - Save



Labels and saves the settings for a setup for future use.

1. Press the Save File soft key.
2. Enter a file name using the thumbwheel and arrow keys.

**Note:** Use up-and-down arrow keys to move vertically and the wheel to move horizontally along the Input Panel. Use the right-and-left keys to toggle between the text fields (Name, Title, etc.)

## Recall Setup

---

Recalls a saved setup and sets the instrument parameters to run the recalled setup.

## Recall Default Setup

---

Recalls the factory default setup and sets the instrument parameters to run this setup.

## Manage Setup Files

---

Allows access to the file management of the saved Setups.

**Figure 11 Setup - Manage Setup Files**

Setup Menu 07:36:34 AM 18-Aug-2008

Mode: Spectrum Analyzer (Spec An) Measurement: Adjacent Channel Power

Setup: 870.292500-873.982500 MHz, RBW: 10 kHz, VBW: 3 kHz

Adjacent Channel Power: Measure the ratio of leakage power in the adjacent power channel

Setup	Freq	Mode	Time/Date	Type
Backup SA	870.292500-873.9...	Spec Analysis	2:37PM/14-Aug-2008	C
Backup VNA	825.000000-895.0...	VN Analysis	1:10PM/05-Aug-2008	C
Factory SA	100.000000-3.600...	Spec Analysis	10:15AM/24-Apr-2...	C
Factory VNA	325.000000-3.600...	VN Analysis	11:46AM/15-Apr-2...	C
General SA(08-04 11:5...	100.000000-3.600...	Spec Analysis	11:54AM/04-Aug-2...	C
General VNA(08-05 13:...	325.000000-3.600...	VN Analysis	1:10PM/05-Aug-2008	C
General VNA(08-05 13:...	825.000000-895.0...	VN Analysis	1:17PM/05-Aug-2008	C
General VNA(08-05 13:...	825.000000-895.0...	VN Analysis	1:17PM/05-Aug-2008	C

Copy Setup to USB Drive

Copy All Setups to USB Drive

Copy Setup from USB Drive

Delete

Delete All Setups

View Setup

Back...

... Setup | Address | Input | Freq | Range | Span | Mode | Resolution | Bandwidth | Video Bandwidth | ...

Help

### Copy Setup to USB Drive

Copies the selected Setup on the list to a connected USB drive.

### Copy All Setups to USB Drive

Copies all the Setups on the list to a connected USB drive.

### Copy Setup from USB Drive

Copies a saved Setup from a connected USB drive.

### Delete

Deletes the selected Setup on the list.

### Delete All Setups

Deletes all of the Setups on the list, with the exception of the factory setup.

## View Setup

Displays the properties of a selected saved Setup on the list.

**Figure 12 Setup - View Setup**

Setup Menu 05:01:47 AM 26-Aug-2009

Mode: Spectrum Analyzer (Spec An) Measurement: General SA Measure  
Setup: 45.000080-55.000000 MHz, RBW: 300 kHz, VBW: 100 kHz  
General Spec An Measurement

Previous Setup:	Setup Label:	Next Setup:
Loss (Less than -60)	Backup SA	Backup VNA
	File Path: \\FlashFX Disk\My Setups\backu	
	File Size: 0 bytes	
	Setup: Spectrum Analysis: General Set	
	Setup Type: Custom	
	Creation Date: 12/49:41 PM 25/08/2009	
	Change Date: 12/49:41 PM 25/08/2009	
	Date Last Used: 10/14:49 AM 24/04/2007	
	History:	
	Favorite: No	
	Auto Start: No	
	Start Freq: -45.000080 MHz	
	Stop Freq: 55.000000 MHz	
	Center Freq: 50.000040 MHz	
	Freq Span: 9.999920 MHz	
	Amplitude Offset: 0.000 dBm	
	Resolution Bandwidth: 300 kHz Auto Mode	
	Video Bandwidth: 100 kHz Auto Mode	
	RBW to VBW Ratio: 3	
	Frequency Span to RBW Ratio: 10	
	Reference: -101.800 dBV	
	Scale: 1.0 dB /Div	

Setup has changed

Recall Setup

Delete

Top of List

Bottom of List

View Next Setup

View Previous Setup

Help

### Recall Setup

Recalls a saved setup and sets the parameters of the SignalHawk to run the recalled setup.

### Delete

Deletes the displayed Setup.

### Top of the List

Displays the Setup from the top of the list of saved Setups.

### Bottom of the List

Displays the Setup from the bottom of the list of saved Setups.

### View Next Setup

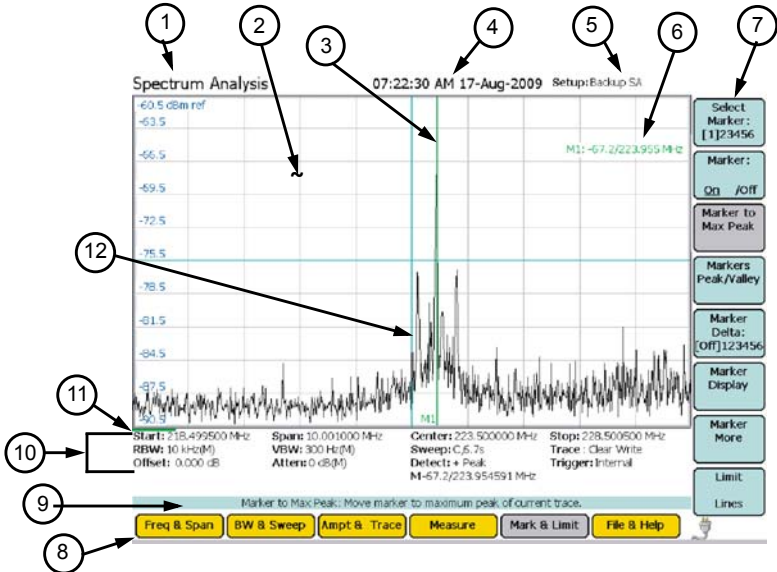
Displays the next Setup on the list of saved Setups.

### View Previous Setup

Displays the previous Setup on the list of saved Setups.

# Looking at the Screen

Figure 13 General Screen Features



Item	Description
1	Name of selected measurement
2	Sweep display area
3	Marker (Line Marker shown)
4	Date and time
5	Name of setup file being used
6	Marker Info
7	Soft key labels
8	Menu key labels
9	Help tips for the current screen
10	Measurement settings
11	Sweep progress bar
12	Data trace

## Vector Network Analyzer Quick Start

---

### CAUTION

Vector Network Analyzer has a +22 dBm (160 mW) max. RF input. Exceeding the maximum input will damage the SignalHawk. If unsure of power levels, measure the test connection with a power sensor before using the SignalHawk.

### CAUTION

Do not turn on a DC bias if the thru cable is attached from the VNA In to the VNA Out. This will damage the VNA input and destroy the unit.

### CAUTION

Center conductor cabling should be discharged prior to connecting. See “Discharging Static Electricity” on page 131. Any large electrostatic discharge or high power RF applied directly to the RF input or output will cause internal damage and void the warranty.

Power to any adjacent broadcast antennas should be shut down as well. If adjacent antenna broadcasts cannot be terminated, then adding sufficient external attenuation to the input of the instrument prior to connecting is recommended. Failure to do so could result in irreparable damage to the SignalHawk.

1. Measure the output power of the system being tested, or signal power, at the system’s test port using a power meter, service monitor, or equivalent.

**Note:** *Ensure the output power is less than +22 dBm (160 mW).*

2. Power up the SignalHawk.
3. In the Start Menu, use the arrow keys to highlight the desired measurement and press Enter.
4. In the Freq & Span Menu, set the frequency range (See “Freq & Span Menu” on page 58).
5. Do one of the following:
  - For Match or Cable Loss Measurement:
    - a. Select either the Match or Cable Loss measurement.
    - b. Press Calibrate
    - c. Select Open, Short, or Load (soft keys) on RF Out corresponding with a calibrated open, short, or load connected to the RF Out port.
    - d. Connect the cable and antenna to the RF Out test port.

**Note:** *Maximum input is +22 dBm (160 mW).*



- For Distance-to-Fault (DTF) Measurement:
  - a. Press Measure then Measure: Match and then DTF (soft keys).
  - b. Press Ampt & Trace then Units (soft key) then select VSWR or Rtn Loss dB.
  - c. Press Measure then select either Meter or Feet in Distance Units (soft key).
  - d. Press DTF Wizard (soft key), follow instructions displayed, and then skip to step h.
 

**Note:** *For Manual setup of DTF, follow steps e to m.*
  - e. Connect the cable and antenna to the RF Out test port.
 

**Note:** *Maximum input is +22 dBm (160 mW).*
  - f. Press Cable then Cable List (soft keys).
  - g. Scroll to desired cable and press Select or Enter.
 

**Note:** *May also manually enter cable Vp and Loss.*
  - h. Press Ampt & Trace then Autoscale (soft key) to view trace on display OR manually adjust scale with Max and Min Level settings.
  - i. Press Sweep then Data Points (soft keys).
  - j. Adjust data points until stop distance is just greater than the length of cable.
 

**Note:** *If needed, repeat steps i and j.*
  - k. Press Calibrate
  - l. Select Open, Short, or Load (soft keys) on RF Out corresponding with a calibrated open, short, or load connected to the RF Out port.
  - m. Connect the cable and antenna to the RF Out test port.
 

**Note:** *Maximum input is +22 dBm (160 mW).*
- For Gain & Loss Measurement:
  - a. Press Measure then Measure: Gain & Loss (soft keys).
  - b. Press Ampt & Trace and Pwr Out.
 

**Note:** *Default is 0 dBm, may set as low as -40 dBm for amplifier gain or as high as +10 dBm for antenna isolation measurements.*
  - c. Press Calibrate, connect cable from the VNA RF Out to In port, and press Cable from RF Out-In.
 

**Note:** *Connect loads to VNA RF Out and In ports, press Loads on RF Out & In and wait until done. This is recommended to measure antenna isolation in the -80 to -90 dB range.*
  - d. Press Skip Other Cals.
  - e. Connect the device under test (e.g. cable, amplifier, filter, antennas) to the VNA RF Out and In ports.
 

**Note:** *Maximum input on each port is +22 dBm (160 mW).*

### CAUTION

Do not turn on a DC bias if the thru cable is attached from the VNA In to the VNA Out. This will damage the VNA input and destroy the unit.

- f. Press Ampt & Trace and Sweep.

**Note:** Press IFBW and set to 100 Hz with down arrow key. This is recommended to measure antenna isolation in the -80 to -90 dB range.

**Note:** Steps g through j are needed to bias a tower top amplifier (TTA), otherwise go to step k.

**Note:** It is recommended that the Signal Hawk be plugged into a power outlet.

- g. Press Measure and Bias Tee Voltage, toggle to +12V or +24V per the TTA requirements.
- h. Ensure that Pwr Out (in the Ampt & Trace menu) is set as low as -40 dBm to avoid overdriving the TTA.
- i. Connect output of TTA to VNA RF In port and input of TTA to VNA RF Out port.
- j. Press Bias Tee (in the Measure menu) and toggle on.  
**Note:** Bias Tee should be toggled off when not in use.
- k. Press Ampt & Trace and Autoscale (soft key) to view trace on display OR manually adjust scale with Max and Min Level.

6. Press Ampt & Trace then Units (soft key) select VSWR or Rtn Loss dB.

**Note:** Units cannot be set when the SignalHawk is in Cable Loss or Gain & Loss measurement mode.

7. Wait for one sweep, then go into the Ampt & Trace Menu and press Autoscale to view trace on display OR manually adjust scale with Max and Min Level (see "Ampt & Trace Menu" on page 70).
8. In the File & Help Menu, press Quick Save Trace to save the data (see "File & Help Menu" on page 77).

# Spectrum Analyzer Quick Start

## CAUTION

Spectrum Analyzer has a +20 dBm (100 mW) max. RF input. Exceeding the maximum input will damage the SignalHawk. If unsure of power levels, measure the test connection with a power sensor before using the SignalHawk.

## CAUTION

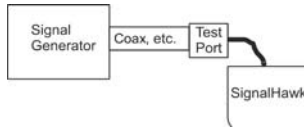
Center conductor cabling should be discharged prior to connecting. See “Discharging Static Electricity” on page 131. Any large electrostatic discharge or high power RF applied directly to the RF input or output will cause internal damage and void the warranty. Power to any adjacent broadcast antennas should be shut down as well. If adjacent antenna broadcasts cannot be terminated, then adding sufficient external attenuation to the input of the instrument prior to connecting is recommended. Failure to do so could result in irreparable damage to the SignalHawk.

1. Measure the output power of the system being tested, or signal power, at the system’s test port using a power meter, service monitor, or equivalent.

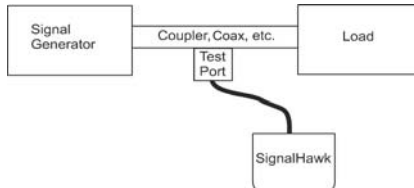
**Note:** *Ensure the output power is less than +20 dBm (100 mW).*

2. Connect the SignalHawk’s “RF Input” connector:

- **For low-power applications**, connect directly to the output of the signal source. See the below graph:



- **For high-power applications**, use a directional coupler or attenuator to reduce the output level of the signal source. See the below graph:



3. Power up the SignalHawk.
4. In the Start Menu, use the arrow keys to highlight the desired measurement, and press Enter.
5. In the Freq & Span Menu, set the frequency range (See “Freq & Span Menu” on page 58).
6. Wait for one sweep, then go into the Ampt & Trace Menu and press Auto-scale (see “Ampt & Trace Menu” on page 70).

7. In the Measurement menu, select the desired measurement.
  - "Spectrum Analysis Measurement" on page 84.
  - "Occupied Bandwidth Measurement" on page 85.
  - "Channel Power Measurement" on page 87.
  - "Adjacent Channel Power Measurement" on page 89.
  - "Time Domain (Zero Span)" on page 91.
  - "Field Strength Measurement" on page 92.
  - "Demodulate Signal" on page 93.
  - "Carrier-to-Interference Ratio" on page 94.
  - "Out-of-Band and In-Band, Out-of-Channel Spurious" on page 96.
  - "Water Fall" on page 72.
8. Turn on markers or limit lines if needed (see "Marker On / Off" on page 73 and "Limit Lines" on page 75).
9. Make a sweep.
10. In the File & Help Menu, press Quick Save Trace to save the data (see "File & Help Menu" on page 77).



## Global Positioning System (GPS)

---

**Note:** Only firmware version 1.2.01302009 or higher will support the GPS sensor. To get the latest firmware, refer to "Upgrading the Software/Firmware" on page 131.

A Bird Electronic Compact GPS Sensor can be connected to the COM1 serial port located on the back panel. It is used to record geographic position information associated with a trace.

GPS status is indicated by an icon in the upper right corner of the display as follows:

Icon	Status	Recording Action
None	No GPS data is being received.	No geographic position is saved with the trace.
	GPS data is being received; however, there is no positional fix.	No geographic position is saved with the trace.
	A positional fix is available from the GPS.	The entire GGA message (essential fix data which provides 3D location and accuracy data) is recorded in the saved trace file.

### Adding Custom Locations

---

See "Customizing SignalHawk Content" on page 129.

The proper settings are very important for the most accurate information possible. The SignalHawk can be configured in various ways, allowing for a wide range of measurement capabilities.

## **Core Soft Key Functions**

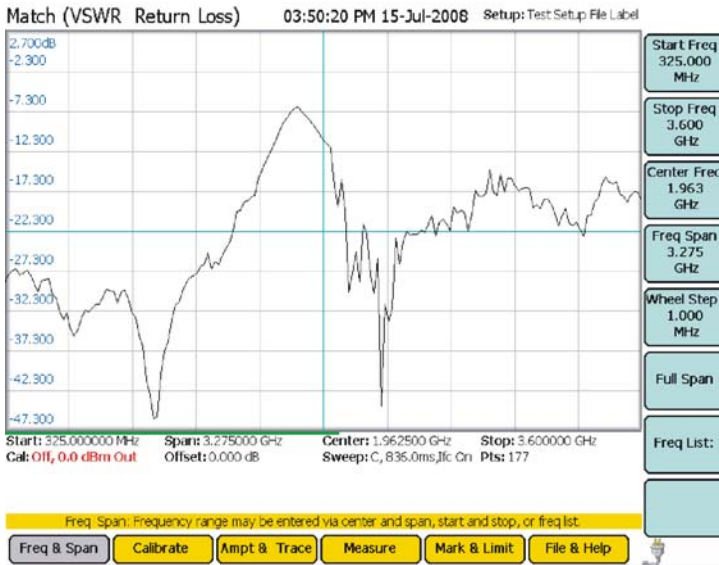
---

“Soft Keys” serve multiple functions on the SignalHawk. There are four core functions:

1. **On/Off Button** - Push to toggle the corresponding function on or off.
2. **Pop-Up Menu Button** - Push to pop-up lists and drop menus. Use the arrow key, wheel, etc. to select from the pop-up (e.g. Freq list).
3. **Highlight Button** - Push to highlight selectable variants (e.g. Freq).
4. **Trigger Event Button** - Push to start a function (Full Span).

# Freq & Span Menu

Figure 14 Freq & Span Menu



In the Freq & Span Menu, the range of frequencies to sweep are specified. Frequencies can be selected at spans from 1 kHz up to the entire range of the instrument.

**Note:** Information obtained from readings set below the minimum rating may not be accurate.

These frequencies can be set to sweep by one of the following methods:

- Set the Center Freq and Freq Span.
- Set the Start Freq and Stop Freq.
- Select the Full Span of the instrument.
- Select a band from the Freq List.

The most common of these methods is to set the center frequency and a frequency span (a range) and let the SignalHawk calculate the start and stop frequencies for the sweep. Reducing the span will usually provide more detail and lower the noise floor. For many measurements, set the center frequency to the center of the signal being tested.

## Start / Stop Freq and Center / Span

---

These settings control the frequency range being swept.

**Note:** *“Center / Span” are used in this manual, but using “Start / Stop Freq” achieves the same results.*

After pressing the soft key, it will highlight the active function. Then the following can be performed:

- **Up/Down Arrow Keys:** Increase and decrease the frequency or span in small steps.
- **Left/Right Arrow Keys:** Increase and decrease the frequency or span in large steps.
- **Thumbwheel:** Each click of the thumbwheel changes the frequency or span by the value of the “Wheel Step” soft key.
- **Number Keys:** Press any key except +/- to open a box to type in a new frequency. If a mistake happens, press Esc/Back. When done, press enter (to keep the same frequency units) or press the soft key corresponding to the desired units.

## Wheel Step

---

When another frequency function is active and the thumbwheel is turned, the value will change in steps of the “Wheel Step”. After pressing the “Wheel Step” soft key to highlight it, the following is enabled:

- **Up/Down Arrow Keys and Thumbwheel:** Change the step value by a small amount.
- **Left/Right Arrow Keys:** Change the step value by a large amount.
- **Number Keys:** Press any key except +/- to open a box to type in a new frequency. If a mistake is made, press Esc/Back. When done, press enter, or press the soft key corresponding to the desired units.

## Full Span

---

Press this to set the Start Freq to 1.6 MHz, and the Stop Freq to the max freq of the unit, currently 3.6 GHz.

## Freq List

---

Pressing this opens up a list of predefined frequency bands. Use the up/down arrows and thumbwheel to scroll to the desired band and press the “Select” soft key to use it. Recently used bands are displayed at the top of the list.





## Calibrate Menu

---

Ensure that the calibration is done properly. For the best results, use a Bird calibration kit. If calibration is not done properly, the readings from the VNA will be wrong.

**Note:** *Set any parameters that the calibration may depend on BEFORE starting the calibration of the unit. Power output should be set depending on isolation or gain measurement.*

**Note:** *If the SignalHawk is not calibrated before taking measurements, readings will be wrong. Calibrating should be done after setting everything else, and before making measurements.*

**Note:** *Many factors play a key role in proper calibration. Be sure to mind the internal temperature of the unit as well as length of time between calibrations. In addition, many setting changes, especially changing the frequency setting, can turn calibration off.*

1. Connect one of the following to the RF connector:

- Open
- Short
- Load (the “calibration standard”)
- Cable from RF Out-In (2-Port Only)
- Loads on RF Out & In (2-Port Only)

**Note:** *For faster calibration sweep times when measuring antenna isolation in the -80 to -90 dB range, it is recommended to use less data points.*

2. Press the corresponding button in the calibrate menu.

**Note:** *For measuring antenna isolation in the -80 to -90 dB range: Connect loads to VNA RF Out and In ports, press Loads on RF Out & In and wait until done. Bird recommends using a calibrated load (e.g. CAL-MN-C) for the RF Out and a standard load (e.g. 2-T-MN) for the RF In.*

3. Wait for the sweep to finish: the button will un-highlight and “Done” will appear in the label.

**Note:** *If the key is pressed again, it will re-take that sweep.*

4. Remove calibration standard.

5. Put on a different calibration standard.

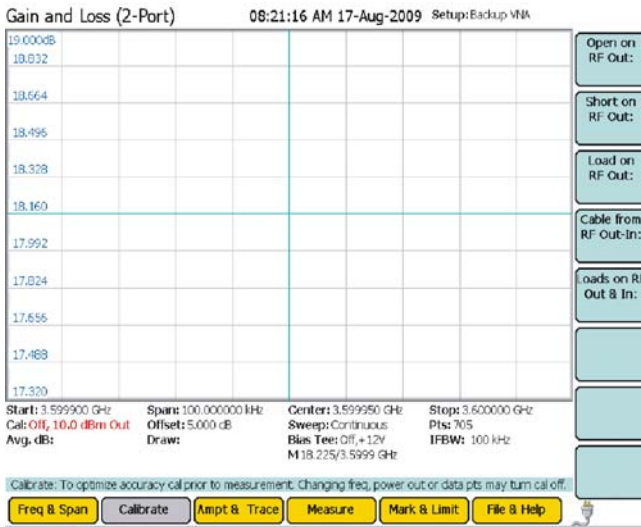
6. Repeat steps 1 to 4 until all calibration types are done.

7. Wait while the unit processes the information. When ready, the unit will exit the Calibrate menu and the Cal: area of the status bar will display the calibration method that was performed.

**Note:** If the unit is operating without valid calibration, the text in the cal area of the status bar will be red and say "Off". If it has a calibration, the calibration method will be listed in black text.

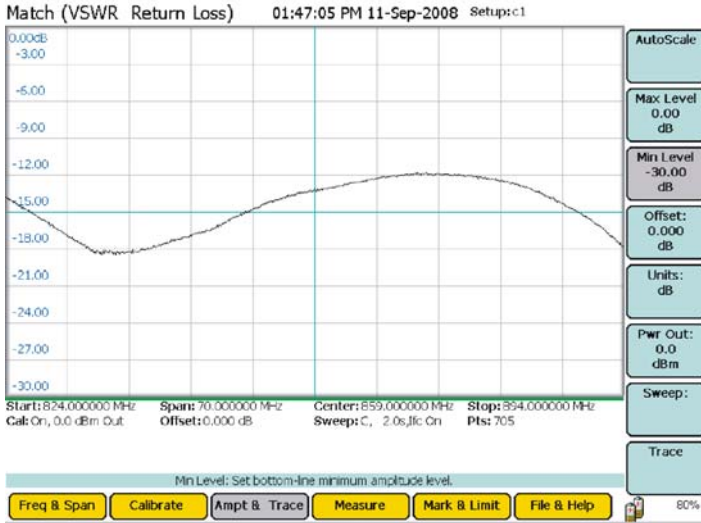
**Note:** For most isolation and gain measurements, only a thru cal (Cable from RF Out-In) is needed.

**Figure 16 Example, Calibrate Menu**



# Ampt & Trace Menu

Figure 17 Example, Ampt & Trace Menu



## Autoscale

Resizes the graph to fit the whole trace on the screen. This function will change the reference and scale of a trace.

## Max Level

Sets the upper limit of the vertical axis.

## Min Level

Sets the lower limit of the vertical axis.

## Offset

Shifts the signal to compensate for external factors (attenuation, couplers, amplifiers, etc.) This allows for a true signal level reading.

1. Measure the total amount of loss for all attached signal devices.
2. Enter the measured amount as the Offset value or gain.

**Example** - The system has 10 dB of loss due the use of a coupler; enter the value of 10 in the Offset). Offset range is -100 to +100.

## Units

---

### VSWR

$$[1 + \text{Sqrt}(Pr/Pf)]/[1 - \text{Sqrt}(Pr/Pf)]$$

### Return Loss

$$(dB) = 10 \times \text{Log}(Pr/Pf)$$

### rho

$$\text{Sqrt}(Pr/Pf)$$

### Match %

$$100 \times (1 - Pr/Pf)$$

### Reflection %

$$100 \times (1 - Pr/Pf)$$

### Pwr Out

---

Controls the power level of the signal that is sent out to the RF port. The SignalHawk then measures the power that comes back. The default setting is 0 dBm. Can be set from -20 to +10 in 1 dB steps. This should be set as high as possible without overpowering the system.

**Note:** For most measurements, the output should be set to 0dBm or lower.

**Note:** For systems with good match (low reflected power) set the output higher to improve the signal to noise ratio.

### Sweep

---

Sets the parameters of the sweep for the SignalHawk.

#### Cont/Single

Toggles the sweep setting from a single sweep to a continuous cycle of sweeping and recording.

**Note:** Selecting this will enable a manual trigger soft key that starts the sweep when pressed.

#### Data Points

Controls the sweep speed and level of detail. The range can go from 12 to 11265 points per sweep.

**Note:** Increasing the number of data points increases the measurable distance in Distance-to-Fault measurements and increases the detail in Measure Match mode measurements. Use a smaller number of points when frequency resolution is not critical & a faster sweep time is desired. Use more points for a more accurate display of finer frequency divisions.

- If there are fewer points than screen pixels, the unit will interpolate between them.  
**Note:** *Once the unit is calibrated, reducing the number of points below 1409 does not require recalibration.*
- If there are more points, the unit will draw multiple data points in each column.

## Interference Immunity

Controls the discrimination between interfering signals from the system being tested. If there are other signals in the system being tested, this function will enable the unit to ignore the extraneous signals better, and record a more accurate measurement.

**Note:** *This feature should be enabled at all times, except when testing long lengths of cable.*

## IFBW

Increases and decreases the internal filtering of the measurement. It can also function as a smoothing effect when measuring very low return losses. It achieves this by reducing the IFBW (towards 100 Hz) which reduces the noise amplitude of the display. Also, lower IFBW settings result in longer sweep times, and increase the effectiveness of the interference immunity. The range is from 100 Hz to 1 MHz.

**Note:** *For Gain-and-Loss 2-Port Measurement Only - When measuring antenna isolation in the -80 to -90 dB range, the IFBW setting needs to be 100 Hz.*

## Trace

---

Opens a trace submenu with the following options:

### Clear Write

Switches off the Average and Max Hold functions.

### Max Hold

Holds and displays the highest trace data points.

### Average

Displays the running average of multiple readings.

**Note:** *This may be used to smooth a trace.*

### Average Readings

Sets the number of readings to be averaged. The valid range is from 2 to 1024.

### Reset Average

Resets the current running average of multiple readings.

## Water Fall

The Water Fall is a spectrogram that shows how the spectral density of a signal varies with time and presents it in a visual image.

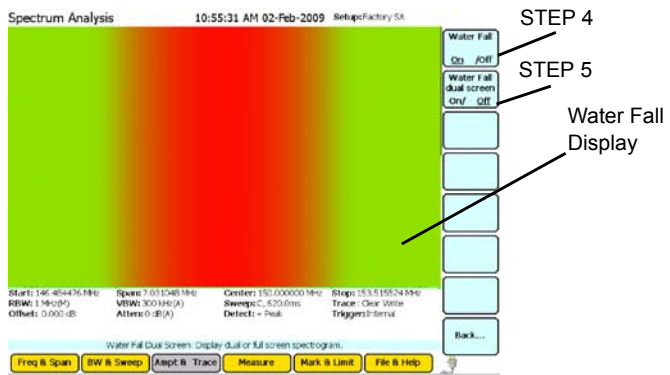
The Water Fall display is used to identify intermittent interference. Power is linearly mapped to graph display color. When mapped out, the horizontal axis is the Frequency rating while the vertical axis is Time.

The color ranges from dark blue, at minimum power, to red, at maximum power.

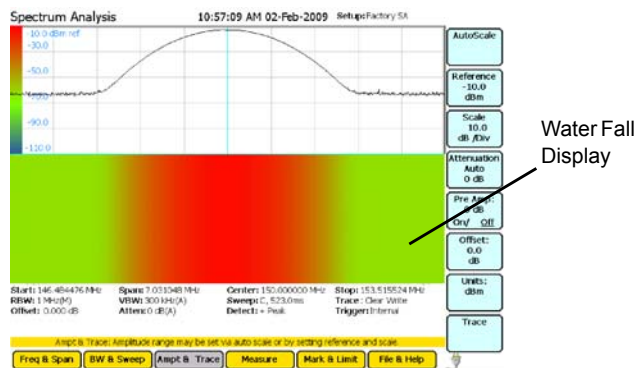
To activate the Water Fall display:

1. Go to the Ampt & Trace menu.
2. Press the Trace soft key.
3. Press the Water Fall soft key.
4. Turn the Water Fall spectrogram on.
5. Select the dual screen display, if desired

**Figure 18 Example, Water Fall Spectrogram - Full Screen**



**Figure 19 Example, Water Fall Spectrogram - Half Screen**





## **Threshold Offset**

Raises a signal above the noise floor. This filters out low level peaks allowing for a clear reading.

## **Marker to Max Peak or Marker to Min Valley**

Sets the marker to either the maximum peak or minimum valley depending on the functionality chosen in Markers Detect. See “Markers Detect” on page 33.

## **Marker to Next Peak Left or Marker to Next Valley Left**

Cycles the active marker to the left through the points on the trace either from highest peaks or lowest valleys (see “Markers Detect” on page 33) progressing to the left.

## **Marker to Next Peak Right or Marker to Next Valley Right**

Cycles the active marker to the right through the points on the trace either from highest peaks or lowest valleys (see “Markers Detect” on page 33) progressing to the right.

## **All Markers to Max Peaks or All Markers to Min Valleys**

Sets all the markers to either the maximum peaks or minimum valleys depending on the functionality chosen in Markers Detect. See “Markers Detect” on page 33.

## **All Markers Off**

Turns off all markers on the trace.

## **Marker Delta**

---

Turns On/Off and displays the delta of the one to five markers.

## **Marker Display**

---

### **Marker Type**

Sets the current marker to either be displayed as a line or floating numbered icon.

### **All Markers Type to Icon**

Sets all markers to be displayed as floating numbered icons.

### **All Markers Type to Line**

Sets all markers to be displayed as numbered lines.

### **Marker Display**

Turns On/Off and sets the location of the delta display into one of the four corners of the screen.



## Marker More

---

Sets the properties of active markers through the following attributes:

### **RSSI (Received Signal Strength Indicator)**

Turns the audio indicator On or Off (an electronic ping). See “Received Signal Strength Indicator (RSSI)” on page 92.

### **Volume**

Sets the volume of the electronic ping generated from the RSSI.

### **Marker Freq to Center**

Moves the current marker to the center frequency.

## Limit Lines

---

Limit lines give notification of when a signal has reached or gone over a set measurement amount. Limit lines can be moved with arrow keys.

**Note:** *All valid traces are black, and any part of any trace that is outside of a limit is red. Red indicates a failed limit.*

### **Limit Upper/Lower**

Pick between upper & lower limit line.

### **Limit On/Off**

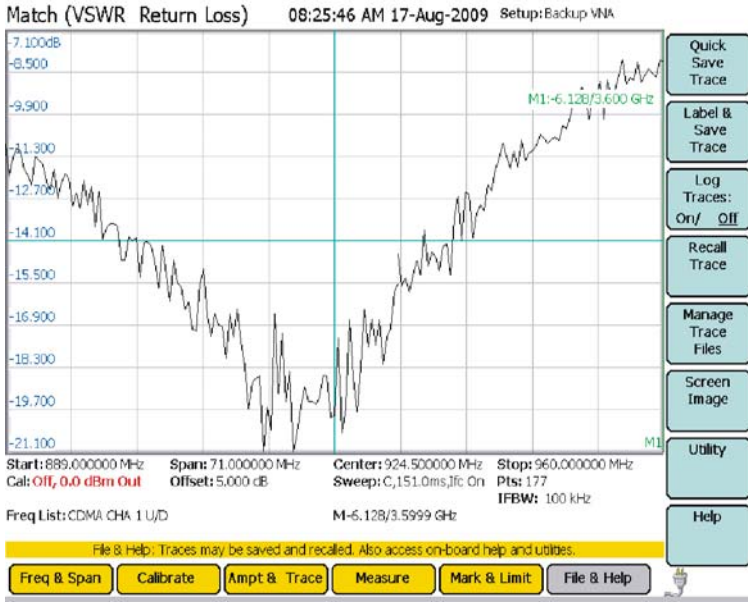
Pick between limit line on or off.

### **Limit Alarm On/Off**

Pick whether a limit line fail makes the unit beep.

# File & Help Menu

Figure 21 Example, File & Help Menu



## Quick Save

Saves the trace that is displayed on the screen.

### To save the trace:

1. Press the File & Help menu key
2. Press the Quick Save Trace soft key.

The trace is stored as a file in the internal memory of the instrument. Each quick save is stored in a separate file that is named using the measurement and date-time file naming format: *Measurement name(MM-DD HH-MM-SS).shf*. Where the first MM is the month, DD is the day, HH is the hour, the second MM is the minute, and SS is the second of the time when the file was saved.

The PCTool utility (supplied on the CD that ships with the instrument), enables copying and/or moving stored files from the internal memory to an external storage device.

## Label & Save Trace

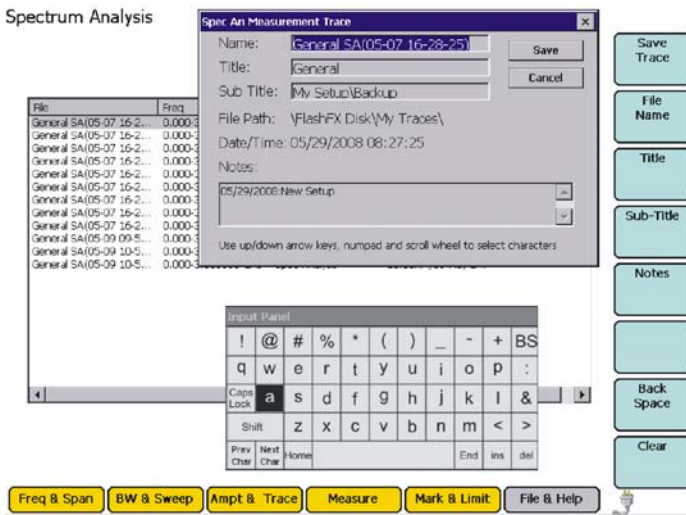
---

Labels and saves the trace for future use.

1. Press the Save Trace soft key.
2. Enter a file name using the thumbwheel and arrow keys.

**Note:** Use the up-and-down arrow keys to move vertically and the wheel to move horizontally along the Input Panel. Use the right-and-left keys to toggle between the text fields (Name, Title, etc.)

**Figure 22 Example, Save Trace**



## Log Traces

---

Press the soft key to turn this function on. Once on, it saves a sweep at a preset sample rate.

**Note:** The sample rate can be set from 60 to 3600 seconds.

## Recall Trace

---

Opens up a submenu with three options:

### Recall Trace

Displays a saved trace on the screen.

### Recall & Compare

Displays a saved trace overlapping over the current trace on the screen.

**Note:** The Saved trace is orange. The current trace is black.

### Clear Recalled Trace

Removes the saved trace from the screen.

## Manage Trace Files

Copy trace files to and from an external storage device (thumbdrive, PC, etc), and delete traces.

## Screen Image

Figure 23 Example, Screen Image



### Quick Save Screen

Saves the current trace with a standard naming convention.

**Note:** Files are saved in .bmp format with the naming convention of "ScreenDDHHMMSS.bmp".

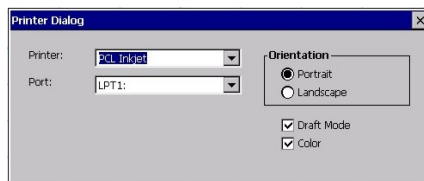
### Full Screen

Enlarges the graph area to the size of the whole screen. Press escape to go back to regular screen.

### Print Screen Image

Prints the current screen image and presents print setting options for print adjustment.

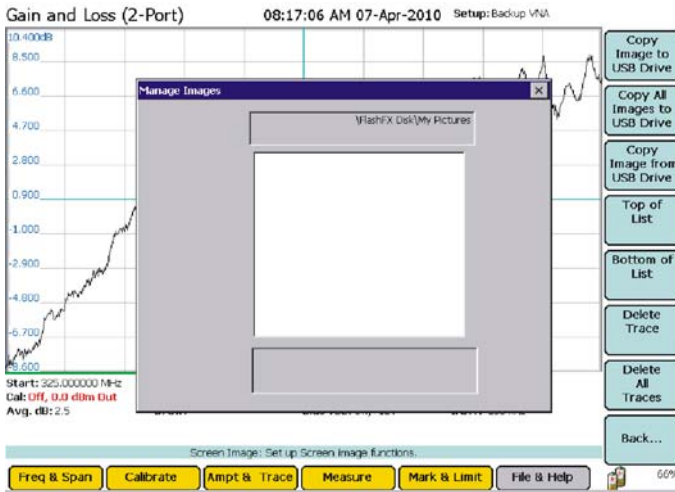
Figure 24 Print Screen Menu



## Manage Image Files

Launches the image file manager.

**Figure 25** Manage Image Files



**Copy Image to USB Drive** - Saves selected image to the USB drive.

**Copy All Images to USB Drive** - Saves all images in the directory to the USB drive.

**Copy Image from USB Drive** - Saves image to the internal memory of the SignalHawk.

**Top of List** - Selects the image listed at the top of the directory.

**Bottom of List** - Selects the image listed at the bottom of the directory.

**Delete Trace** - Deletes the selected image.

**Delete All Traces** - Deletes all the images listed in the directory.

## Utility

---

See "Utility Main Menu" on page 126.

## Help

---

Enables various Help sections that can be accessed via the soft keys. The Help sections are listed below:

- VNA Help (with Match, DTF, Cable Loss, and Gain & Loss sections)
- Spectrum Analyzer Help
- Power Meter Help
- Custom Help

**Note:** *The DTF section of the VNA Help is also accessible in the DTF measurement screen.*



In the Vector Network Analyzer mode, the following measurements can be made:

- "Match Measurement" on page 42.
- "Distance to Fault (DTF) Measurement" on page 46.
- "Cable Loss (1 Port) Measurement" on page 54.
- "Gain & Loss (2 Port) Measurement" on page 55.

## Match Measurement

---

This measurement displays how well matched a system is to a 50 ohm characteristic impedance. Return loss is a measure of impedance mismatch between two or more circuits.

The SignalHawk can calculate the system match as VSWR, Return Loss, Reflection Coefficient, Match Efficiency % and Reflection %.

### Equations

---

#### VSWR

$$VSWR = [1 + Sqrt(Pr/Pf)]/[1 - Sqrt(Pr/Pf)]$$

#### Return Loss

$$RL = -20\log|\Gamma|$$

#### Reflection Coefficient

$$\Gamma = \left| \frac{1 - VSWR}{1 + VSWR} \right|$$

#### Match efficiency %

$$MatchEfficiency(Percent) = 100 \times (1 - (Pr/Pf))$$

#### Reflection %

$$100 \times (1 - Pr/Pf)$$

1. Measure the output power of the system being tested, or signal power, at the system's test port using a power meter, service monitor, or equivalent.

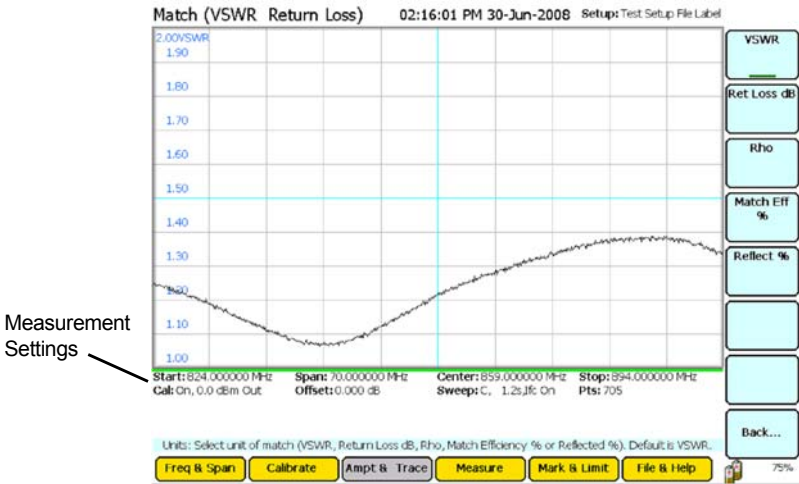
**Note:** *Ensure the output power is less than +22 dBm (160 mW).*

2. Power up the SignalHawk.
3. In the Start Menu, use the arrow keys to highlight the desired measurement and press Enter.
4. In the Freq & Span Menu, set the frequency range. See "Freq & Span Menu" on page 58.
5. Select either Match or Cable Loss measurement.
6. Press Calibrate and press Open, Short, and Load (soft keys) on RF Out with calibrated open, short, and load on RF Out port.
7. Connect the cable and antenna to the RF Out test port.

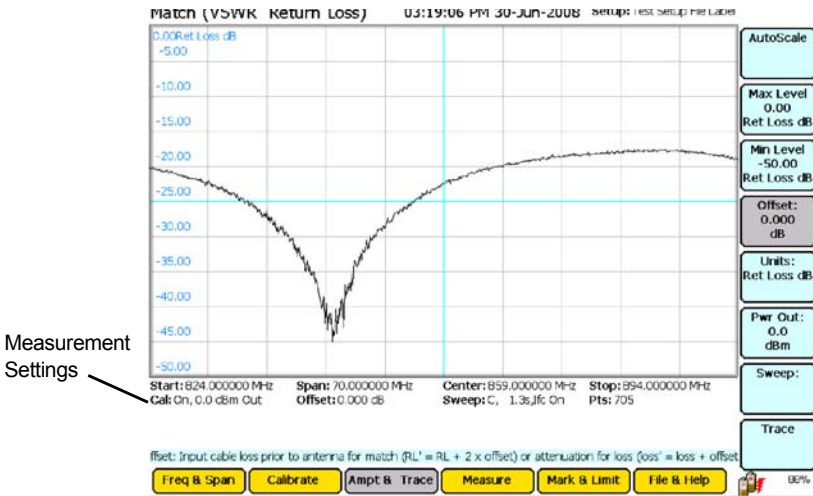
**Note:** *Maximum input is +22 dBm (160 mW).*



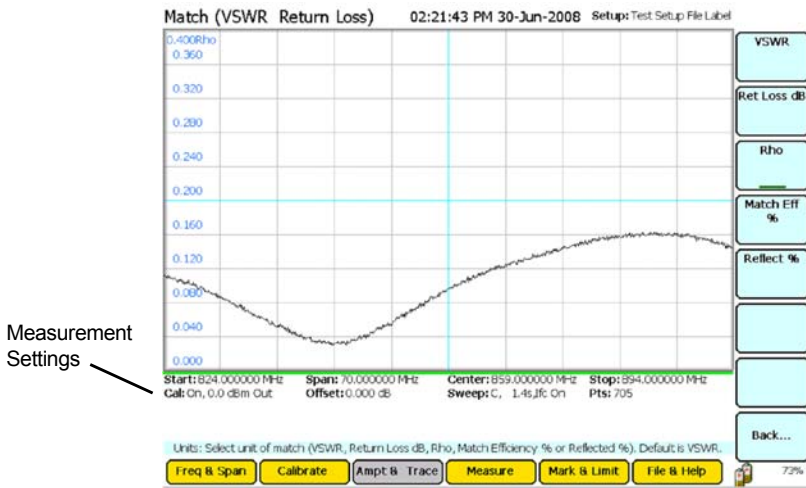
**Figure 26 Example Match Measurement - VSWR**



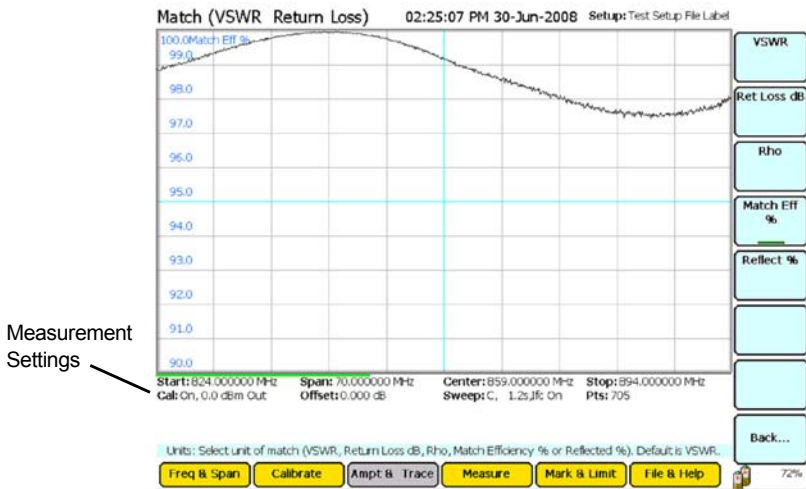
**Figure 27 Example Match Measurement - Return Loss**



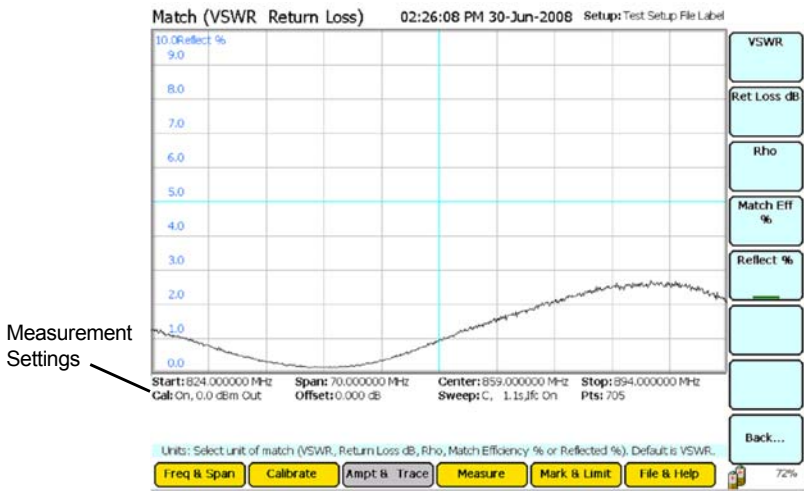
**Figure 28 Example Match Measurement - Rho**



**Figure 29 Example Match Measurement - Percent Efficiency**



**Figure 30 Example Match Measurement - Percent Reflected**



## Distance to Fault (DTF) Measurement

---

This measurement will display the distance to a fault in a given length of cable. The standard settings for this measurement are Start & Stop Distances, Distance Units, Cable Velocity Propagation & Loss, and Smoothing. These settings can be adjusted using either the thumbwheel or keypad.

**Note:** *Changing the frequency span or the max distance will automatically turn calibration off. Always set the frequency span or max distance before calibrating the unit. The maximum distance measured is determined by the frequency span, the velocity of propagation of the cable ( $V_p$ ), and the number of data points to measure these factors. This is discussed in the following paragraphs:*

**Distance** - Normally when a frequency span is specified, the SignalHawk calculates the maximum measurable distance. For this measurement, the distance to be measured is entered, see “Start Distance” on page 47 and see “Stop Distance” on page 48, and the SignalHawk calculates the frequency span. Use the DTF Wizard to manually enter the cable length. See “Estimated Cable” on page 52.

**Note:** *When the distance is entered manually, be sure to select the data points before entering the max distance. See “Data Points” on page 48.*

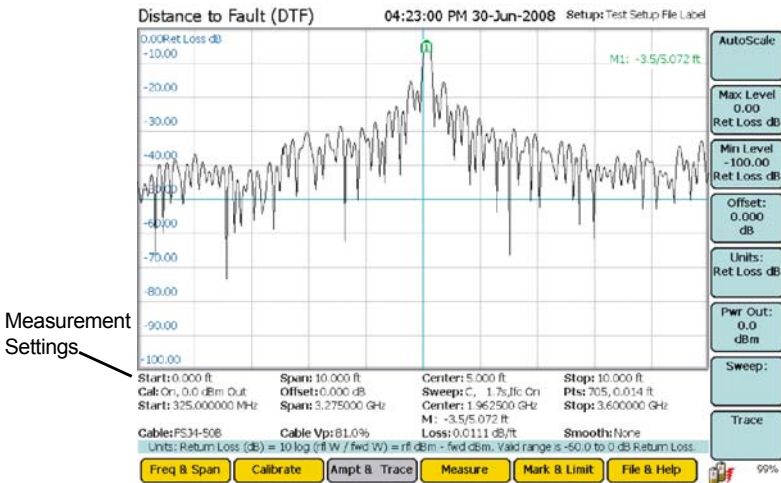
**Note:** *If a maximum distance is less than the total length of the cable system, the trace may show a spike that is not a fault, but rather an echo from the portion of the cable that is beyond the length chosen. Such a spike is known as an alias. To avoid aliasing, always set the Stop Distance to a value that is a few feet or meters greater than the entire length of the cable system.*

**Data Points** - If the number of data points increases, the measurable distance increases. See “Data Points” on page 48.

**Frequency Span** - If the frequency span narrows, the measurable distance increases.

**Velocity of Propagation** - The velocity of propagation is a characteristic of the cable and is expressed as a percentage. Contact the cable manufacturer to get the velocity of propagation value for the cable being used.

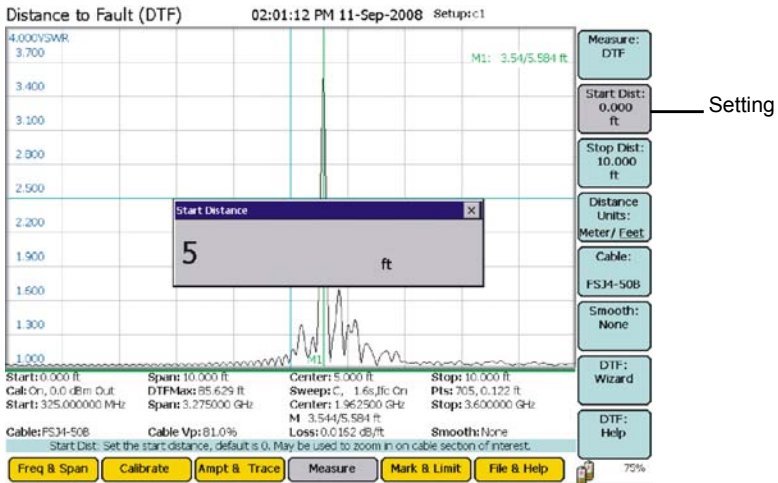
**Figure 31 Example, Distance-to-Fault**



## Start Distance

Sets the starting distance for a measurement within the cable system.

**Figure 32 Example, Distance-to-Fault - Start Distance Setting**

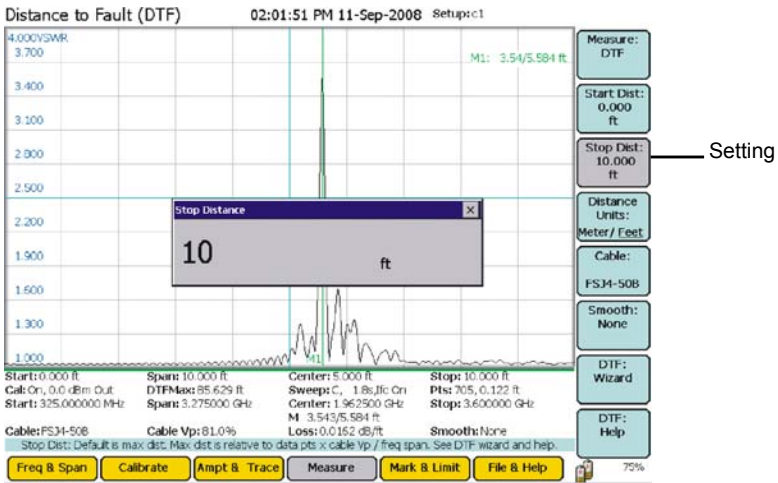


## Stop Distance

Sets the stop distance for a measurement within the cable system.

**Note:** Set the Stop Distance to a value that is a few feet or meters greater than the entire length of the cable system to avoid aliasing.

**Figure 33 Example, Distance-to-Fault - Stop Distance Setting**



## Data Points

**Note:** This is not an option in the measurement, but affects it.

If the number of data points increases, the measurable distance increases (1409 points results in twice the distance of 705 points, and 11265 points results in sixteen times the distance of 705 points) (see "Amplitude" on page 137). When the number of data points being measured changes, the software automatically computes the new maximum measurable distance. If a maximum distance is entered manually using the DTF Wizard, be sure to select the data points before entering the max distance. Changing data points does not turn calibration off.

## Distance Units

Sets the measurement units. Toggles between Meters and Feet.

## Cable

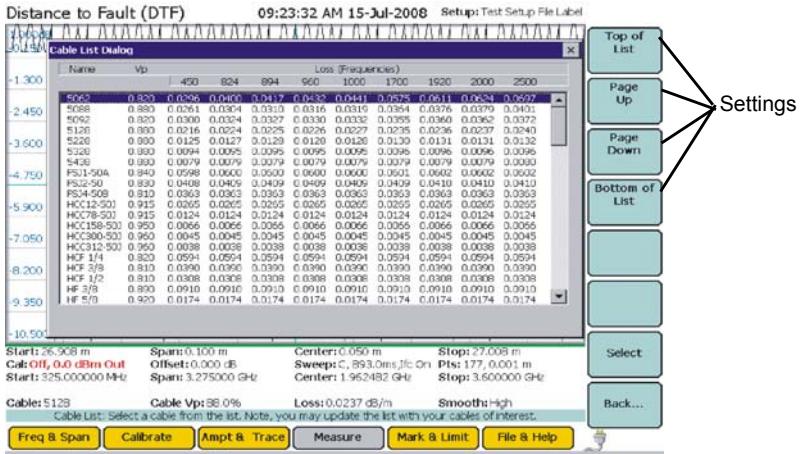
Sets the parameters of the cable being tested.

## Cable List

Select a specific cable from a list.

**Note:** Custom cables can be added to the list. See “Customizing SignalHawk Content” on page 129.

Figure 34 Example, Distance-to-Fault - Cable Setting - Cable List

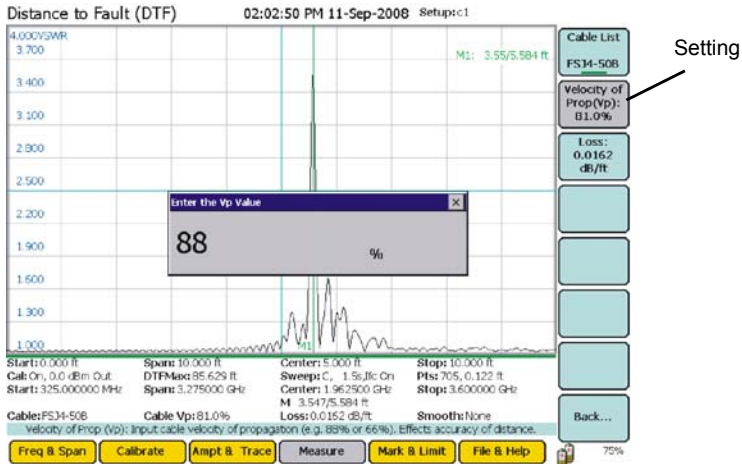


## Velocity

Sets the speed of the signal going through the cable being measured.

**Note:** Changing this setting cancels any selection on the Cable List and changes that setting to “None.”

Figure 35 Example, Distance-to-Fault - Cable Setting - Velocity

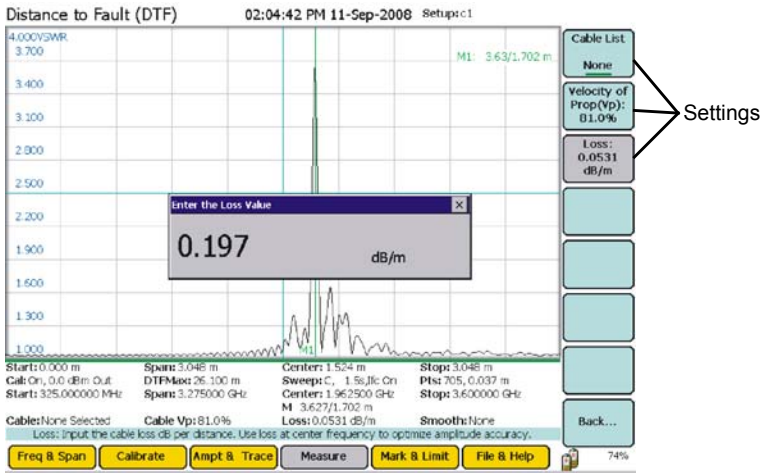


## Loss

Applies an offset to compensate for cable loss.

**Note:** Changing this setting cancels any selection on the Cable List and changes that setting to “None.”

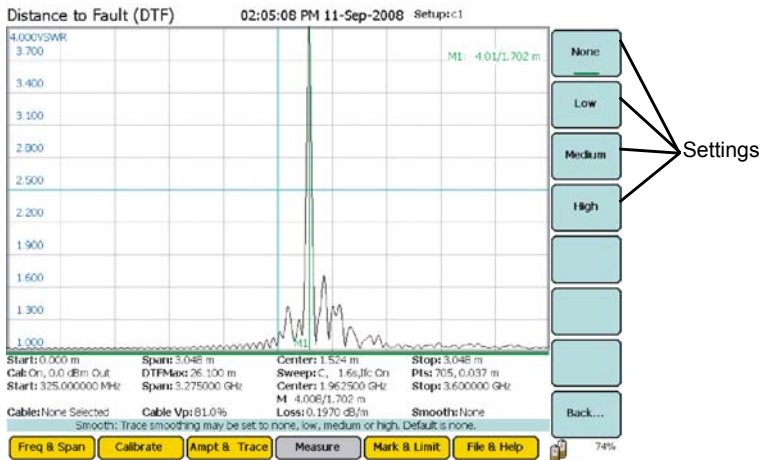
**Figure 36** Example, Distance-to-Fault - Cable Setting - Cable Loss



## Smooth

Smooths the trace line on the display. It can be set to one of four tolerances: None, Low, Medium, and High.

**Figure 37** Example, Distance-to-Fault - Smooth





## DTF Wizard

**Note:** Maximum allowed distance and resolution per point is a complex function of the cable and frequency settings. Use the DTF wizard if the SignalHawk is having issues resolving these functions.

When the DTF Wizard soft key is pressed, a window with a set of adjustable variables will open in the display. Left/right arrow keys change the fields, while up/down arrow keys, the thumbwheel, and the number pad change each field's value.

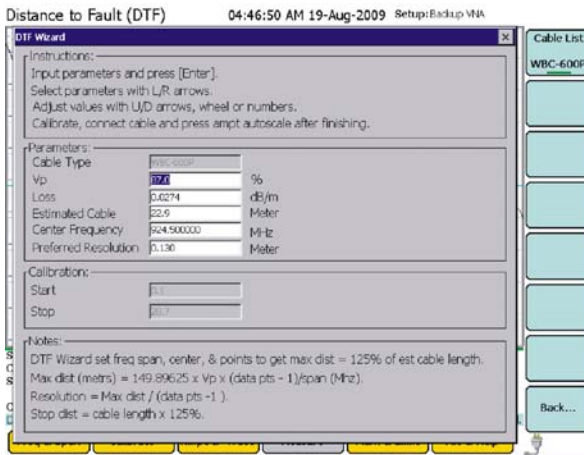
The DTF Wizard takes the guesswork out of setting up a fault-location measurement by requiring knowledge of the type of cable used in the system, total length to the antenna and the desired accuracy of the location of the fault. The DTF Wizard automatically calculates and sets the best parameters of stop distance points and frequency settings.

A Cable List soft key is available. Pressing this will display a series of cables to choose from. The settings for the selected cable will then be displayed in the variable fields. The variables are:

### Vp (Velocity)

Sets the speed of the signal going through the cable being measured.

**Figure 38** Example, Distance-to-Fault - DTF Wizard - Vp



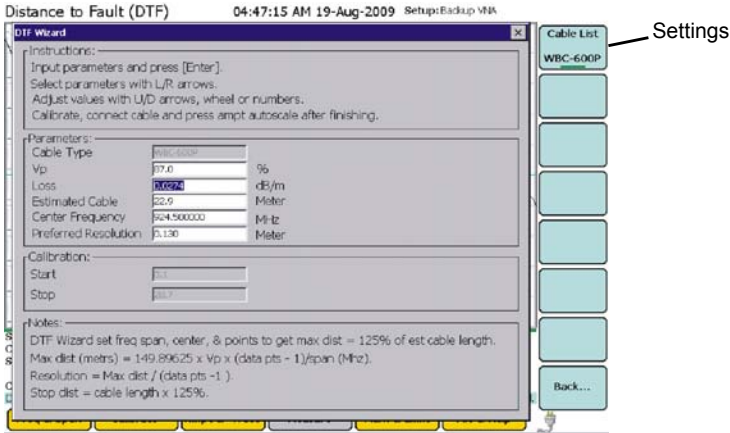
**Note:** The wizard will automatically apply velocity and loss to their fields.

## Loss

Offsets the signal to compensate for cable loss. Using the soft keys, this can be set in either dB/m or dB/ft.

**Note:** *The wizard will automatically apply velocity and loss to their fields.*

**Figure 39** Example, Distance-to-Fault - DTF Wizard - Loss

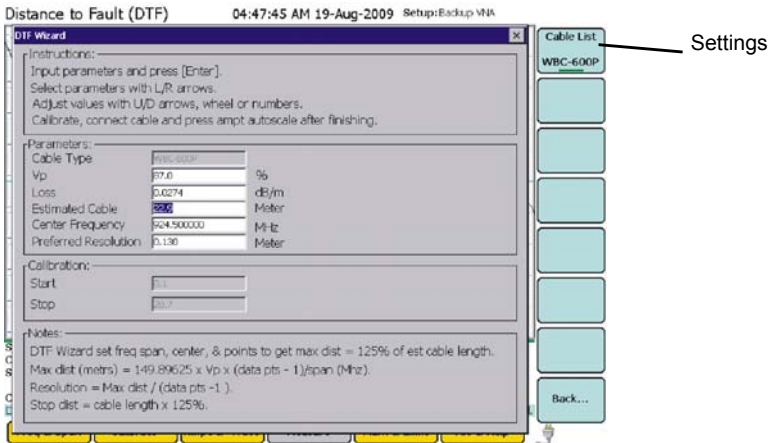


## Estimated Cable

Sets the length or, if length is unknown, the estimated length of the cable being tested. Using the soft keys, this can be set in both Meter and Feet units.

**Note:** *The stop distance automatically sets at 125% of the entered value to help prevent potential false spikes on the trace.*

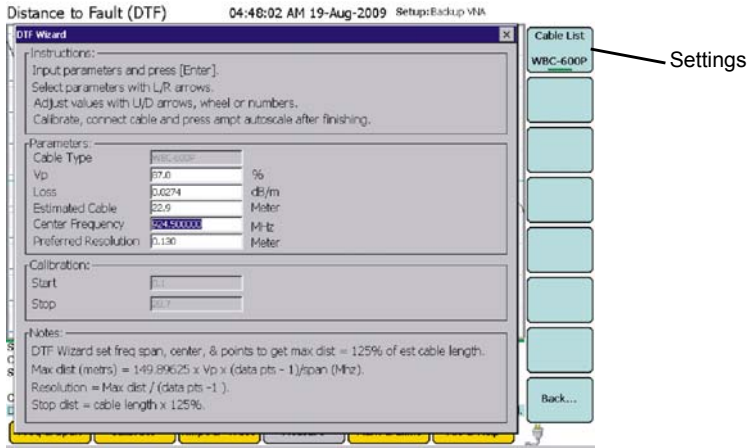
**Figure 40** Example, Distance-to-Fault - DTF Wizard - Estimated Cable



## Center Frequency

Sets the center frequency of the trace to allow for the most accurate reading as possible, whether testing antennas, filters and the like. Using the soft keys, this can be set in Hz, kHz, MHz, and GHz.

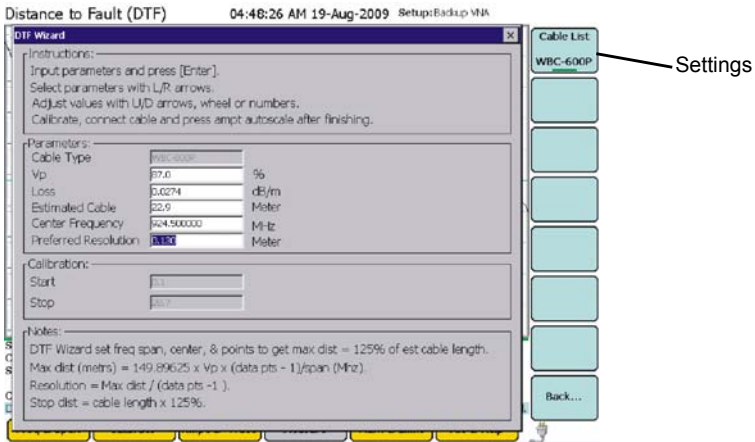
**Figure 41** Example, Distance-to-Fault - DTF Wizard - Center Frequency



## Preferred Resolution

Sets the desired resolution, or distance each pixel of the display covers, of the signal being tested. Using the soft keys, this can be set in Meters and Feet.

**Figure 42** Example, Distance-to-Fault - DTF Wizard - Preferred Resolution



Once all variables are set, press the enter key to begin Calibration. See "Calibrate Menu" on page 27.

# Cable Loss (1 Port) Measurement

This one-port reflection measurement measures the insertion loss of a cable. To measure cable loss, make sure that the cable being tested is not terminated (not connected to anything at the far end).

1. Ensure that the correct adapters, connectors, and a Bird Calibration Combination (cal combo) are used. The frequency band of the system will also be needed.
2. If necessary, connect a phase-stable cable to the test port and connect a Cal Combo to the other end of the cable.
3. Calibrate the SignalHawk. See “Calibrate Menu” on page 27.

**Note:** After calibration, with the load still connected, the output must be below -25 dB. If it is not, there is a problem.

4. Remove the Cal Combo unit from the cable.

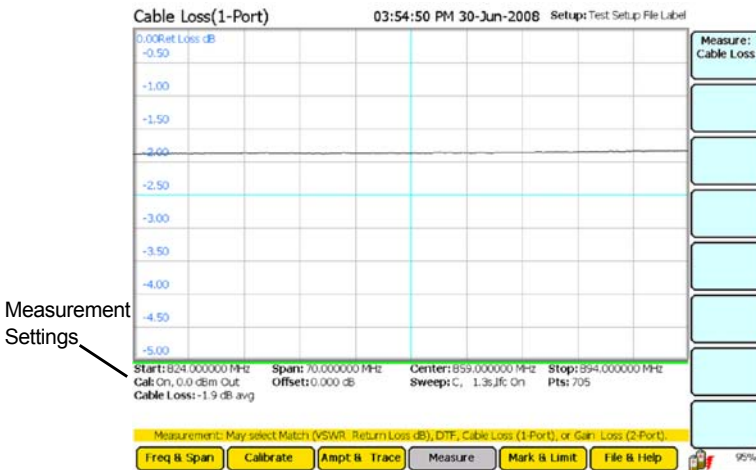
**Note:** Do not disconnect the phase stable cable if used.

5. Connect the cable to be tested to the phase stable cable or test port.

6. Connect Short calibration standard or Short connection on the Cal Combo unit to the other end of the cable being tested.

**Note:** The cable loss as a function of frequency is displayed as the average cable loss displayed in the footer.

**Figure 43 Example Cable Loss**



## Gain & Loss (2 Port) Measurement

This two-port thru measurement is used to test the insertion gain and loss of a cable. To run this measurement, connect the transmitter of the device being tested to Port 1 and the receiver of the device to Port 2. Transmission loss or gain will be negative if the device has a loss and positive if the device has a gain.

$$y = \frac{V_{Transmitted}}{V_{Incident}}$$

**Note:** When measuring antenna isolation in the -80 to -90 dB range, the IFBW setting needs to be 100 Hz.

## Bias Tee Voltage

Adjusts the reading to compensate for any DC voltage added from a bias tee attached to the RF line being tested. The SignalHawk puts a 12V or 24V power supply voltage onto the RF line, so the same line is carrying RF data & power. Then it measures how much current is being drawn from the line.

## Bias Tee

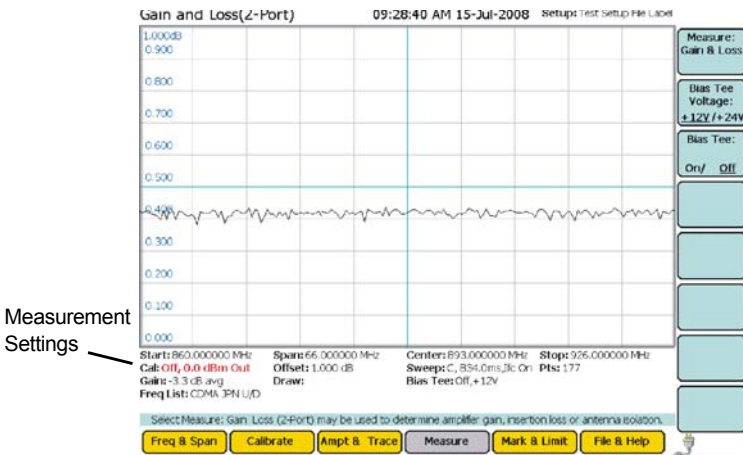
### CAUTION

Do not turn on a DC bias if the thru cable is attached from the VNA In to the VNA Out. This will damage the VNA input and destroy the unit.

Turns the Bias Tee compensator on and off. When this is on, it will display the current draw from the bias tee on the bottom of the display.

**Note:** Overdrawing from the bias tee will cause an automatic shut down of the bias tee. The current overdraw limit is 1,000 mA.

**Figure 44 Example Gain & Loss**





---

## CHAPTER 4 SPECTRUM ANALYZER SETTINGS

The use of proper settings is very important for obtaining the most accurate information possible. The SignalHawk can be configured in various ways, allowing for a wide range of measurement capabilities.

### Core Soft Key Functions

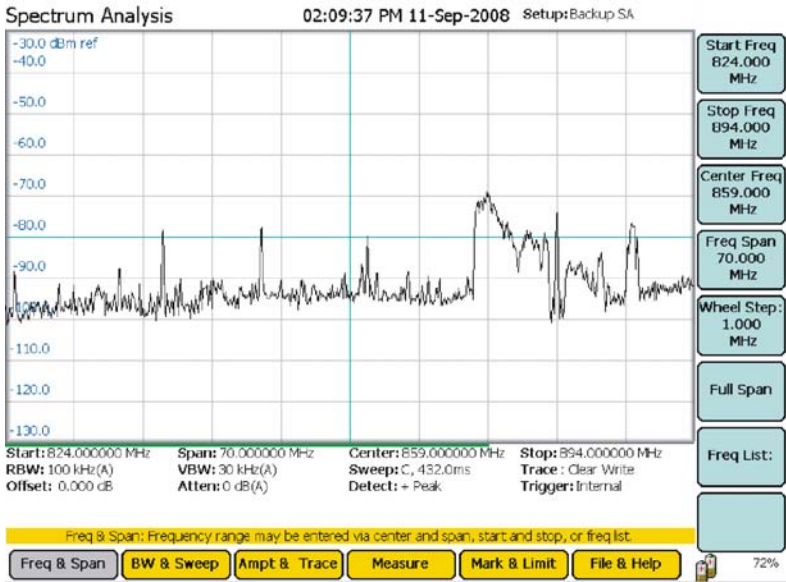
---

“Soft Keys” serve multiple functions on the SignalHawk. There are four core functions:

1. **On/Off Button** - Push to toggle between activating or deactivating a function.
2. **Pop-Up Menu Button** - Push to open pop-up lists and drop menus. Use the arrow key, wheel, etc. to select from the menu (e.g. Freq list).
3. **Highlight Button** - Push to highlight editable items (e.g. Freq).
4. **Trigger Event Button** - Push to start a function (Full Span).

## Freq & Span Menu

Figure 45 Freq & Span Menu



In the Freq & Span Menu, the range of frequencies to be tested is specified. The Spectrum Analyzer can sweep frequencies between 100 kHz and 3.6 GHz.

Frequencies can be selected at spans from 1 kHz up to the entire range of the instrument.

**Note:** Information obtained from readings set below the minimum rating may not be accurate.

These frequencies can be set to sweep by one of the following methods:

- Set the Center Freq and Freq Span.
- Set the Start Freq and Stop Freq.
- Select the Full Span of the instrument.
- Select a band from the Freq List.

The most common of these methods is to set the center frequency and a frequency span (a range) and let SignalHawk calculate the start and stop frequencies. Reducing the span (with RBW and VBW both on auto modes) will usually speed up the sweep, provide more detail, and lower the noise floor. Unless specified otherwise, set the center frequency to the center of the signal being measured.



## Start / Stop Freq and Center / Span

---

These settings control the frequency range being swept.

**Note:** *“Center / Span” are used in this manual, but using “Start / Stop Freq” achieves the same results.*

When the soft key is pressed, the corresponding selection is highlighted. The following can then be performed:

- **Up/Down Arrow Keys:** Increase and decrease the frequency or span in small steps.
- **Left/Right Arrow Keys:** Increase and decrease the frequency or span in large steps.
- **Thumbwheel:** Each click of the thumbwheel changes the frequency or span by the value of the “Wheel Step” soft key.
- **Number Keys:** Press any key to open a box to type the new frequency into. If a mistake is made, press “Esc/Back.” When done, press enter (to keep the same frequency units) or press the soft key corresponding to the desired units.

## Wheel Step

---

When a frequency function is active and the thumbwheel is turned, the value will change in steps of the “Wheel Step”. After pressing the “Wheel Step” soft key to highlight it, the following is enabled:

- **Up/Down Arrow Keys and Thumbwheel:** Change the step value by 10 kHz per press of the arrow key or click of the thumbwheel.
- **Left/Right Arrow Keys:** Change the step value by 1 MHz per press of the arrow key.
- **Number Keys:** Press any key to open a box to type the new frequency into. When done, press enter (to keep the same frequency units) or press the soft key corresponding to the desired units.

## Full Span

---

Sets the Start Freq to 0 and the Stop Freq to the maximum frequency of the unit.

**Note:** *The accuracy spec does not apply below the minimum freq of the unit (100 kHz). The start frequency can be set to 0 as a convenience.*

## Freq List

---

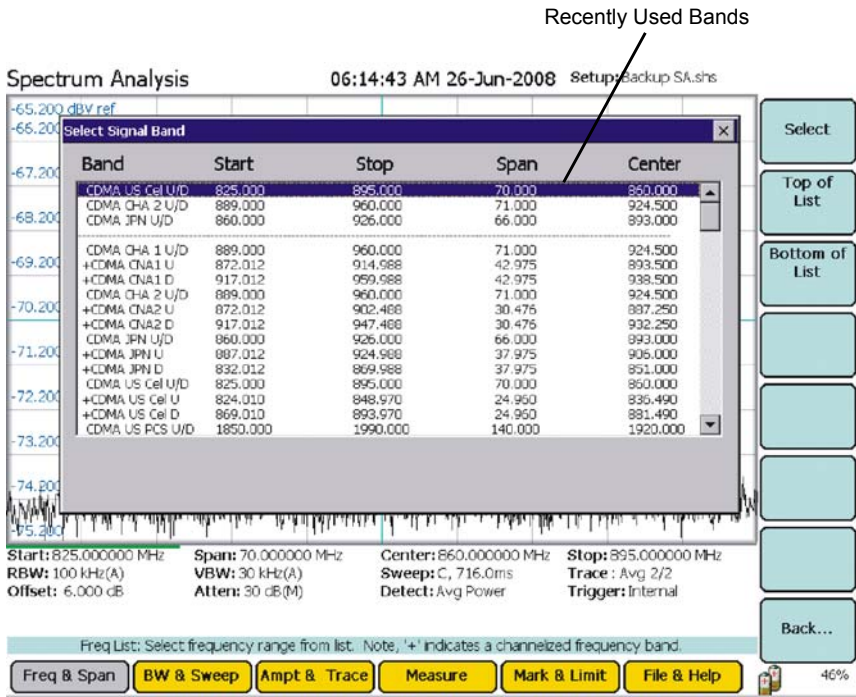
Opens a list of predefined frequency bands. Use the up/down arrows and thumbwheel to scroll to the desired band then press the “Select” soft key to use it. Recently used bands are displayed at the top of the list.

**Note:** Channelized bands are denoted on the Frequency List by a plus sign (+).

## Adding Custom Frequencies

See “Customizing SignalHawk Content” on page 129.

**Figure 46 Example, Freq List**





RBW goes from 100 Hz - 1 MHz in steps of 1 / 3 / 10 (e.g., 1 kHz to 3 kHz to 10 kHz to 30 kHz, etc.)

Video Bandwidth (VBW) determines how much smoothing is performed on a video converted signal before the trace is displayed.

**Note:** VBW goes from 10 Hz to 300 kHz.

- **Wide (high) VBW setting:** Faster sweep times, but can obscure signal details.
- **Narrow (lower) VBW setting:** Better trace smoothing for signals present in high noise levels.

As the VBW is reduced, longer sweep times will be necessary to obtain a measurement. To be useful, VBW must be narrower than RBW. No smoothing takes place when VBW is greater than or equal to RBW.

## Resolution BW Mode

---

Selects RBW mode and also toggles between automatic and manual control. In automatic, RBW is controlled by the current span and the values of Span/RBW and RBW/VBW. If the RBW is changed, the mode will switch to manual.

Auto RBW sets the RBW based upon the frequency span. When in Auto mode, the RBW is set according to the nearest ratio of the Span/RBW selection. The default ratio is 300. When the frequency span is reduced, the RBW will also be reduced accordingly.

***Example** - When the span is changed to 3600 MHz, the RBW will automatically be set to 1 MHz. When the span is reduced to 100 MHz, the RBW will automatically reduce to 300 kHz.*

## Resolution BW

---

Click on the selection to highlight it. Then:

- **Up/Down Keys** - Change the bandwidth incrementally.
- **Left/Right Keys** - Change the bandwidth from min to max.
- **Thumbwheel** - Change the bandwidth incrementally.

## Video BW Mode

---

Selects VBW mode and also toggles between automatic and manual control. In automatic, VBW is controlled by the current span and the values of Span/RBW and RBW/VBW. If the VBW is changed, the mode will switch to manual.

Auto VBW sets the VBW based upon the RBW value. When in Auto mode, the VBW is set according to the nearest ratio as set using the VBW/RBW selection. The default ratio is 3. As the RBW span is reduced the VBW will be reduced accordingly.

***Example** - When the RBW is changed to 1MHz, the VBW will automatically be set to 300kHz. When the RBW is reduced to 30kHz, the VBW will automatically be set to 10kHz.*

## Video BW

---

Click on the selection to highlight it. Then:

- **Up/Down Keys** - Change the bandwidth incrementally.
- **Left/Right Keys** - Change the bandwidth from min to max.
- **Thumbwheel** - Change the bandwidth incrementally.

## Span/RBW

---

Press the Span/RBW soft key then use the arrow keys or the thumbwheel to enter the desired ratio. Values range from 10 to 3600 in steps of one.

When RBW Mode is set to Auto, the ratio of frequency span to RBW determines how the RBW tracks the frequency span. This value is ignored when RBW is set to Manual, in which the soft key legend displays the current value.

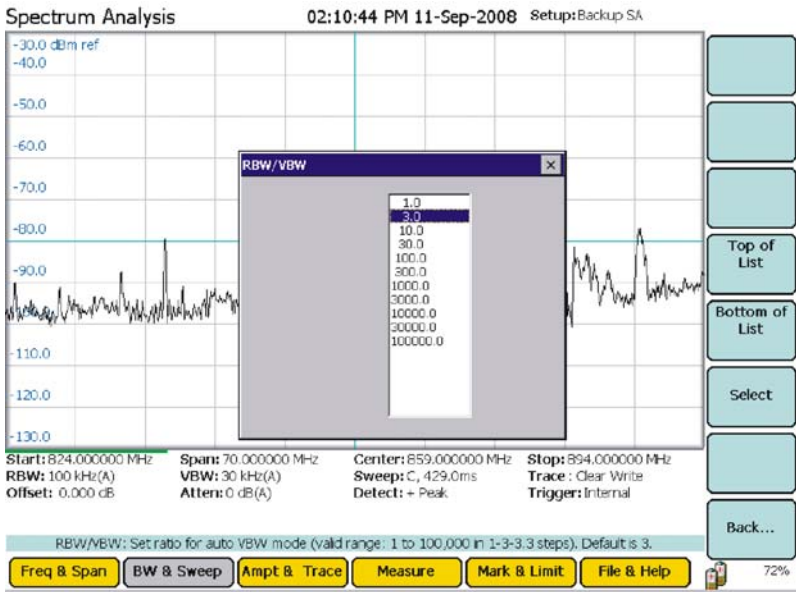
- **Up and Down Arrow Keys** - Press these keys to increase or decrease the ratio in steps of one.
- **Left and Right Arrow Keys** - Press these keys to enter the minimum ratio (left-arrow) or the maximum ratio (right-arrow).
- **Thumbwheel** - Rotate the thumbwheel to increase or decrease the ratio in steps of one.

## RBW / VBW

---

Pressing this key brings up a list of allowed values for RBW / VBW. When VBW is set to auto, the RBW is divided by this value and set as the VBW.

Figure 49 Example, RBW/VBW



## Detection Mode

Depending on measurement settings, more data points are collected than there are pixels on the screen. Detection modes allow the user to choose how the collected data in each pixel is represented.

### + Peak Detection

Returns the maximum value of the data collected for each display pixel. Recommended for pure sine waves or narrow bandwidth signals. In zero-span mode, it acts like a peak detector and can be used to show AM band frequencies.

### - Peak Detection

Returns the minimum value of the data collected for each display pixel. Recommended for displaying the difference between CW and pulsed signals.

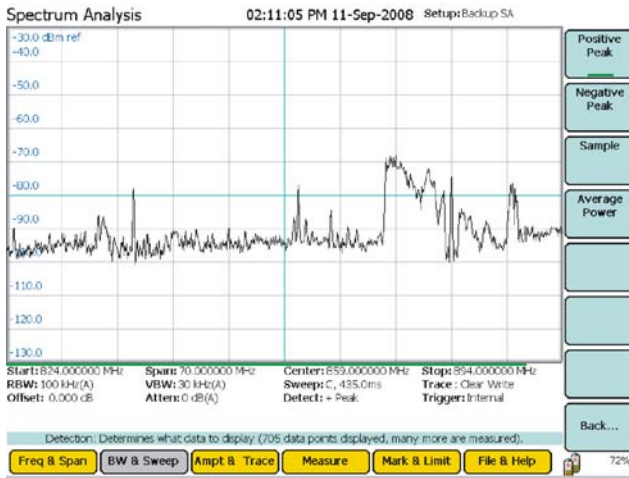
### Sample Detection

Returns a sample of the data collected for each display pixel. Use this method for detecting noise-like signals.

### Average Power

Returns the average of the data collected for each display pixel. Recommended for noise-reduction.

**Figure 50 Example, Detection Mode**



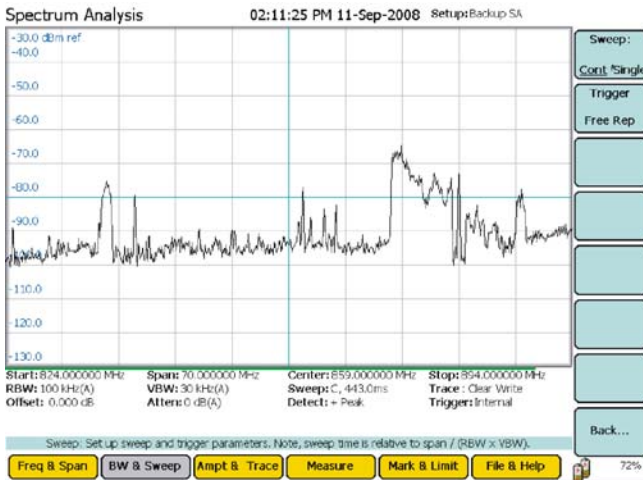
## Sweep More

Sweep sets up the properties of individual sweeps that the SignalHawk performs. It can set whether the sweeping is continuous or single, and the properties of video triggers (if enabled).

### Continuous

**Free Rep** - Sweeps the measurement span continuously.

**Figure 51 Example, Sweep More - Continuous Sweep**



## Single

Performs a single sweep. Before a single sweep is triggered, the SignalHawk will display the previous sweep. To begin a sweep, press the Manual Trigger soft key. After the sweep finishes, it will display the results and stop sweeping.

**Trigger** - Sets the type of trigger that initiates a sweep. There are four types of trigger to choose from:

- **Internal Continuous** - Sweeps continuously and is controlled by the SignalHawk.
- **Internal Single** - Sweeps once when triggered. Controlled by the SignalHawk through the Arm Trigger soft key.
- **External Continuous** - See “External Trigger” below.
- **External Single** - See “External Trigger” below.

**Note:** *Useful for signals that are time varying, such as ones that change slow enough to trigger manually as well as carrier/interference ratios. See “Carrier-to-Interference Ratio” on page 94.*

**Arm Trigger** - Manually initiates a sweep.

## External Trigger

---

### External - Low Level / High Level / Rise Edge / Fall Edge / Either Edge

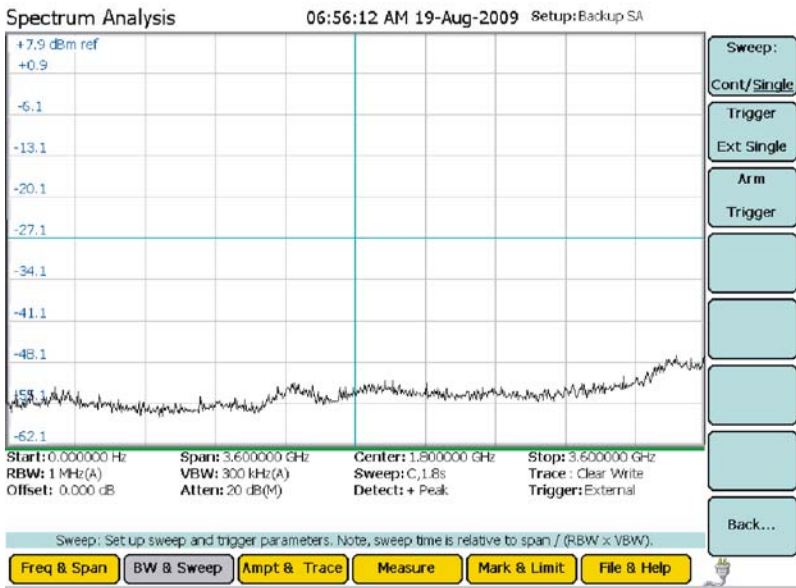
- **Low Level** - Triggers if input =  $0 \pm 0.5$  V (TTL “Low”).
- **High Level** - Triggers if input =  $4.2 \pm 0.8$  V (TTL “High”).
- **Rise Edge** - Triggers if the input goes from “Low” to “High”.
- **Fall Edge** - Triggers if the input goes from “High” to “Low”.
- **Either Edge** - Triggers if the input goes from either “High” to “Low” OR “Low” to “High”.

### Gate Delay

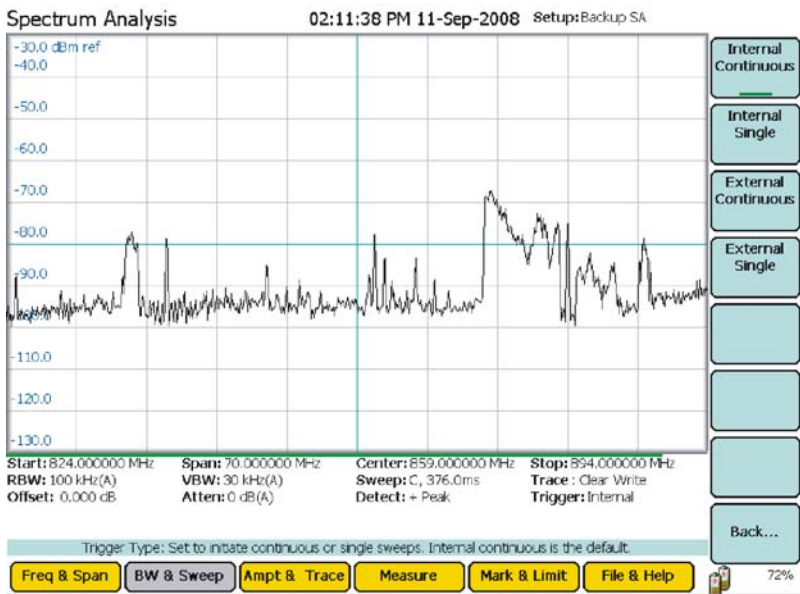
Length of wait after the trigger signal and before beginning a sweep. The range is 100  $\mu$ s to 1 s.



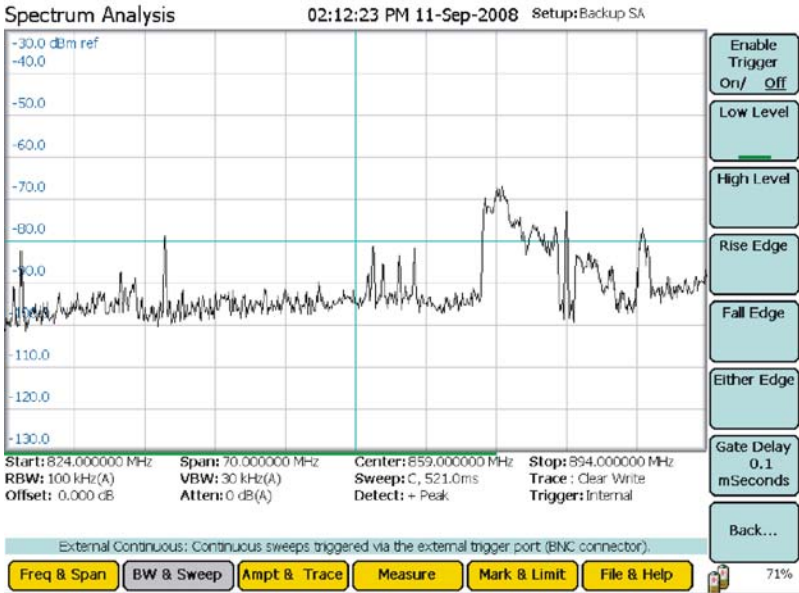
**Figure 52 Example, Sweep More - Single**



**Figure 53 Example, Sweep More - Trigger**



**Figure 54 Example, Low Level / High Level / Rise Edge / Fall Edge / Either Edge**



## Video

**Note:** This can only be used if the Time Domain measurement is enabled. See "Time Domain (Zero Span)" on page 91.

Trigger control and sweeping both happen on the radio frequency connector. Once a sweep is done, it will be displayed until a trigger condition occurs again and it performs another sweep. This is used in zero-span mode.

In order to use this function, the trigger condition needs to be set up:

1. Monitor the RF data to determine the trigger condition.
2. Set the power level at center freq.
3. Set the trigger level:
  - **High Level** - Trigger if dBm rises ABOVE the power level.
  - **Low Level** - Trigger if dBm falls BELOW the power level.
4. Enable the trigger.

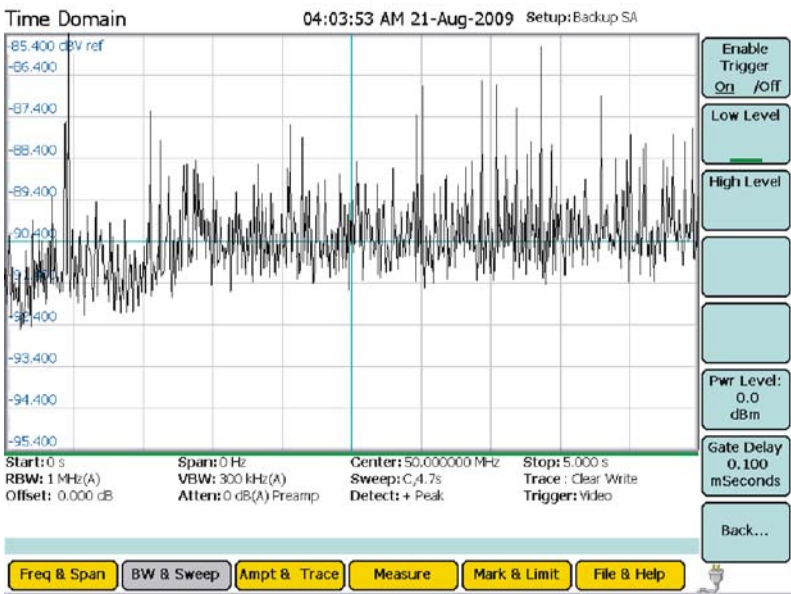
## External - Low Level / High Level / Rise Edge / Fall Edge / Either Edge

- **Low Level** - Triggers if input =  $0 \pm 0.5$  V (TTL “Low”).
- **High Level** - Triggers if input =  $4.2 \pm 0.8$  V (TTL “High”).
- **Rise Edge** - Triggers if the input goes from “Low” to “High”.
- **Fall Edge** - Triggers if the input goes from “High” to “Low”.
- **Either Edge** - Triggers if the input goes from either “High” to “Low” OR “Low” to “High”.

## Gate Delay

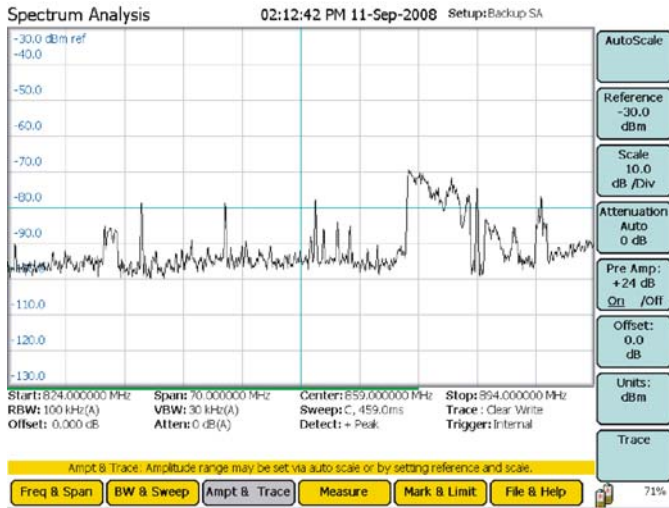
Length of wait after the trigger signal and before beginning a sweep. The range is  $100 \mu\text{s}$  to 1 s.

**Figure 55** Example, Video



## Ampt & Trace Menu

Figure 56 Example, Ampt & Trace Menu



### Autoscale

Resizes the graph to fit the whole trace on the screen. This function changes the reference and scale of a trace.

### Reference

Sets the y-axis value at the top of the graph.

### Scale

Sets the dB value of each partition of the graph on a scale from 1 to 15. The graph is partitioned into 10 divisions, giving a set number of dB per division.

**Note:** This soft key is not displayed if the Units of measure is in Volt or Watt. See "Units" on page 71.

### Attenuation

Controls the built-in attenuator on the signal input. This reduces the amplitude of a high-powered signal. The attenuation can be set to Auto, or at levels of 0, 10, 20, and 30 dB. The reported value of the signal is automatically corrected for the selected attenuation.

**Note:** When the Reference (see "Reference") is set to a higher setting, Attenuation will automatically set itself above this setting.

**Example -** When the Reference is set to 25 dBm, Attenuation automatically sets itself to 30 dB and cannot be lowered.

## Preamp

---

Controls the built-in amplifier on the signal input. This lowers the noise floor, allowing very low power signals be detected, by giving a 24 dB nominal gain boost.

**Note:** *Attenuation is automatically disabled to 0 when Preamp is activated.*

**Note:** *The preamp should not be used with input signals greater than -30 dBm.*

## Offset

---

Shifts the signal to compensate for external factors (attenuation, couplers, amplifiers, etc.). This allows for a true signal level reading.

1. Measure the total amount of loss for all attached signal devices.
2. Enter the measured amount as the Offset value or gain.

**Example -** *The system has 10 dB of loss due the use of a coupler; enter the value of 10 in the Offset. Offset range is -100 to +100.*

## Units

---

Sets the units to be displayed on the graph.

### dBm

$$dBm = 10 \times \text{Log}[\text{Power}(\text{Watts})] + 30dB$$

### dBuV

$$dBm = dBuV - 10 * (\log 50) - 90$$

### dBmV

$$dBm = dBmV - 10 * (\log 50 - 30)$$

### dBV

$$dBm = dBV - 10 * (\log 50 + 30)$$

### Volts

**Note:** *Selecting this unit will disable the Scale option. See "Scale" on page 70.*

$$dBm = 20 \times \text{Log}[\text{Power}(\text{Volts})] + 30dB$$

### Watts

**Note:** *Selecting this unit will disable the Scale option. See "Scale" on page 70.*

$$\text{Watts} = 10^{\wedge}((dBm - 30) / 10)$$

## Trace

---

Opens a trace submenu with the following options:

### **Clear Write**

Switches off the Average and Max Hold functions.

### **Max Hold**

Holds and displays the highest point of any given sweep until Max Hold is turned off.

### **Min Hold**

Holds and displays the lowest point of any given sweep until Min Hold is turned off.

### **Average**

Displays the running average of multiple readings.

**Note:** *This is used to smooth a signal and decrease noise amplitude.*

### **Average Readings**

Sets the number of average readings.

**Note:** *The valid range is from 2 to 1024.*

### **Reset Average**

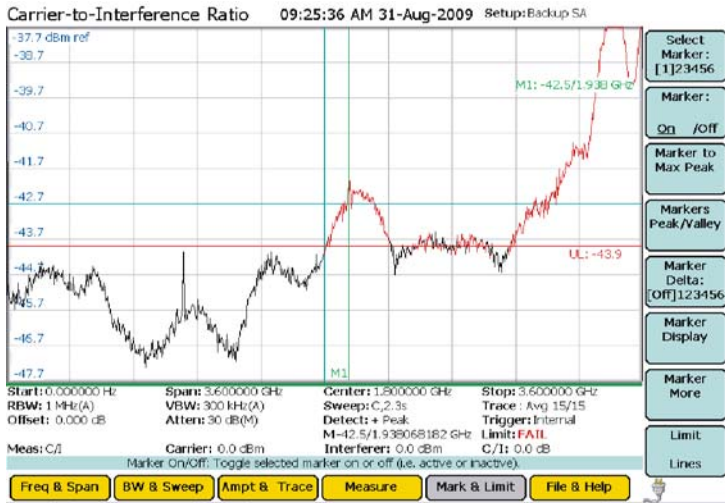
Resets the current running average of multiple readings.

### **Water Fall**

See “Water Fall” on page 32.

## Mark & Limit Menu

Figure 57 Example, Mark & Limit Menu



### Select Marker

Changes the active marker. There are six markers to choose from (measurements that use some of the markers for data display have less selectable markers). Pressing the soft key will cycle through each of the six markers.

### Marker On / Off

Turns a Marker on and off.

### Marker to Max Peak

Moves the active marker to the highest point on the trace.

### Markers to Peak/Valley

### Markers Detect

Toggles the functionality of the submenu between finding peaks or finding valleys.

### Threshold Offset

Raises a signal above the noise floor. This filters out low level peaks allowing for a clear reading.

## **Marker to Max Peak or Marker to Min Valley**

Sets the marker to the either the maximum peak or minimum valley depending on the functionality chosen in Markers Detect. See “Markers Detect” on page 73.

## **Marker to Next Peak Left or Marker to Next Valley Left**

Cycles the active marker to the left through the points on the trace either from highest peaks or lowest valleys (see “Markers Detect” on page 73) progressing to the left.

## **Marker to Next Peak Right or Marker to Next Valley Right**

Cycles the active marker to the right through the points on the trace either from highest peaks or lowest valleys (see “Markers Detect” on page 73) progressing to the right.

## **All Markers to Max Peaks or All Markers to Min Valleys**

Sets all the markers to either the maximum peaks or minimum valleys depending on the functionality chosen in Markers Detect. See “Markers Detect” on page 73.

## **All Markers Off**

Turns off all markers on the trace.

## **Marker Delta**

---

Turns On/Off and displays the delta of the one to five markers.

## **Marker Display**

---

### **Marker Type**

Sets the current marker to either be displayed as a line or floating numbered icon.

### **All Markers Type to Icon**

Sets all markers to be displayed as floating numbered icons.

### **All Markers Type to Line**

Sets all markers to be displayed as numbered lines.

### **Marker Display**

Turns On/Off and sets the location of the delta display into one of the four corners of the screen.

## **Marker More**

---

Sets the properties of active markers through the following attributes:



## **RSSI (Received Signal Strength Indicator)**

Turns the audio indicator On or Off (an electronic ping). See “Received Signal Strength Indicator (RSSI)” on page 92.

### **Volume**

Sets the volume of the electronic ping generated from the RSSI.

### **Marker Freq to Center**

Moves the current marker to the center frequency.

### **Center Freq to Marker**

Sets the center frequency to the frequency of the active marker.

### **Ref Level Ampt to Marker**

Sets the top-line amplitude reference level to the amplitude of the active marker.

### **Frequency Counter**

Turns the Frequency Counter on or off. This enables the frequency read out of all displayed markers to read the exact frequency of the peak within the pixel to a resolution of 1 Hz.

**Note:** *Signals that vary in frequency must be within the RBW to obtain accurate results.*

## **Limit Lines**

---

Limit lines give notification of when a signal has reached or gone over a set measurement amount. Limit lines can be moved with arrow keys.

**Note:** *All valid traces are black, and any part of any trace that is outside of a limit is red. Red indicates a failed limit.*

### **Limit Upper/Lower**

Pick between upper & lower limit line.

### **Limit On/Off**

Pick between limit line on or off.

### **Limit Alarm On/Off**

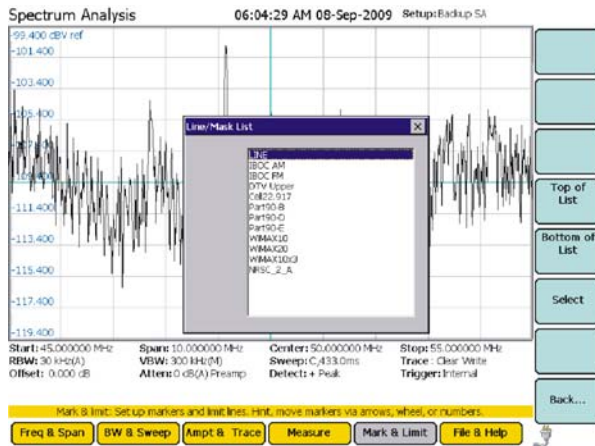
Pick whether a limit line fail makes the unit beep.

### **Select Line/Mask**

Creates a specific set of limit lines and presents a list of these predefined masks to choose from.

**Note:** *Custom Masks can be saved to the Mask list. See “Customizing SignalHawk Content” on page 129.*

**Figure 58 Example, Mask List**

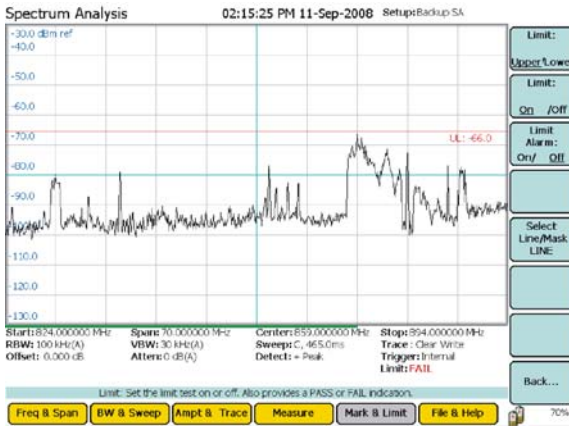


Once a mask is selected, it is controlled by the following options:

**Freq Lock** - Locks the mask onto the selected band even if the frequency is changed.

**EM to Max Peak** - Sets mask's reference level to the maximum peak in each sweep.

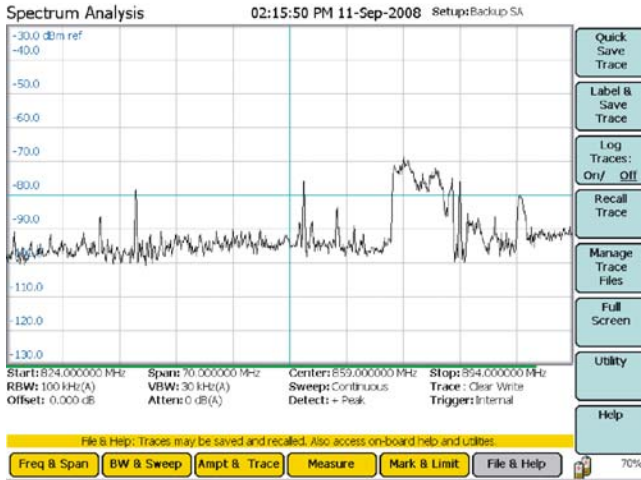
**Figure 59 Example, Limit Line Mask**



## File & Help Menu

When the File & Help menu key is pressed, soft keys for saving the current trace, selecting the utility option, activating the logging feature, and accessing help features are enabled. A trace is saved as a file and stored in the internal memory of the instrument. Using the PCTool utility that is supplied on the CD that ships with the SignalHawk, stored files can be copied or moved from the internal memory to an external storage device (e.g PC, thumbdrive, etc.).

**Figure 60 Example, File & Help Menu**



### Quick Save

Saves the trace that is displayed on the screen.

#### To save the trace:

1. Press the File & Help menu key.
2. Press the Quick Save Trace soft key.

The trace is stored as a file in the internal memory of the instrument. Each quick save is stored in a separate file that is named using the measurement and date-time file naming format: *Measurement name(MM-DD HH-MM-SS).shf*. Where the first MM is the month, DD is the day, HH is the hour, the second MM is the minute, and SS is the second of the time when the file was saved.

The PCTool utility (supplied on the CD that ships with the instrument), enables copying and/or moving stored files from the internal memory to an external storage device.

## Label & Save Trace

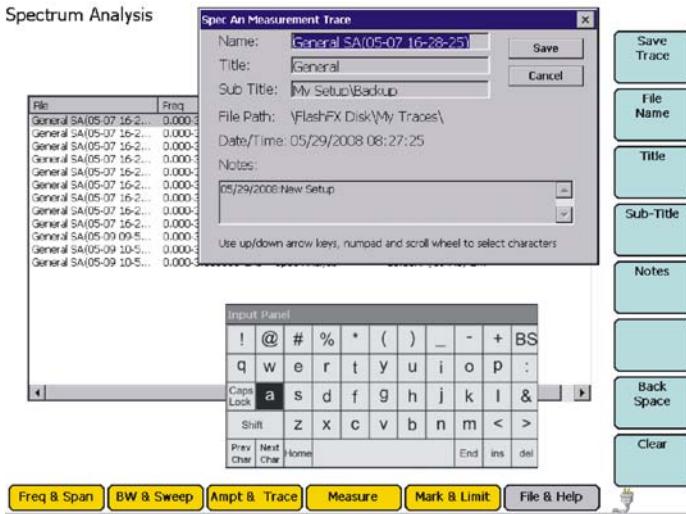
---

Labels and saves the trace for future use.

1. Press the Save Trace soft key.
2. Enter a file name using the thumbwheel and arrow keys.

**Note:** Use the Up-and-down arrow keys to move vertically and the wheel to move horizontally along the Input Panel. Use the right-and-left keys to toggle between the text fields (Name, Title, etc.).

**Figure 61 Example, Save Trace**



## Log Traces

---

Press the soft key to turn this function on. Once on, it saves a sweep at a preset sample rate.

**Note:** The sample rate can be set from 60 to 3600 seconds.

## Recall Trace

---

Opens up a submenu with three options:

### Recall Trace

Displays a saved trace on the screen.

### Recall & Compare

Displays a saved trace overlapping the displayed trace on the screen.

**Note:** The Saved trace is orange. The current trace is black.

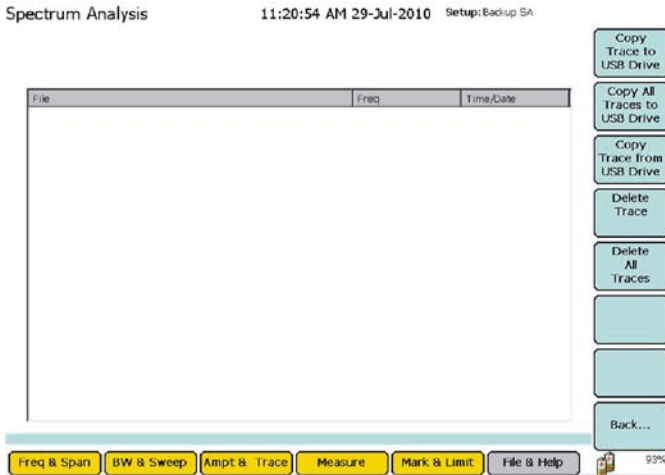
### Clear Recalled Trace

Removes the recalled trace from the screen.

## Manage Trace Files

Copy trace files to and from a thumb drive, and delete traces.

**Figure 62** Example, Manage Trace Files



### Copy Trace to USB Drive

Copies the selected trace to a connected USB drive.

### Copy All Traces to USB Drive

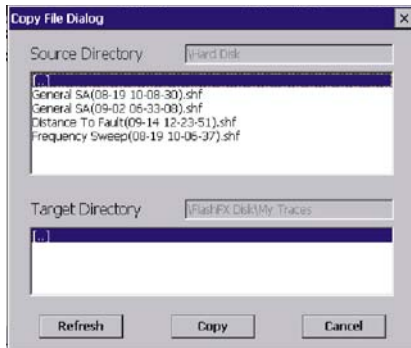
Copies all saved traces to a connected USB drive.

### Copy Trace from USB Drive

Copies a trace from a connected USB drive.

**Note:** Use the keypad and thumbwheel to select the files from the directory.

**Figure 63** Example, Copy Trace from a USB Drive



## Delete Trace

Deletes the selected trace.

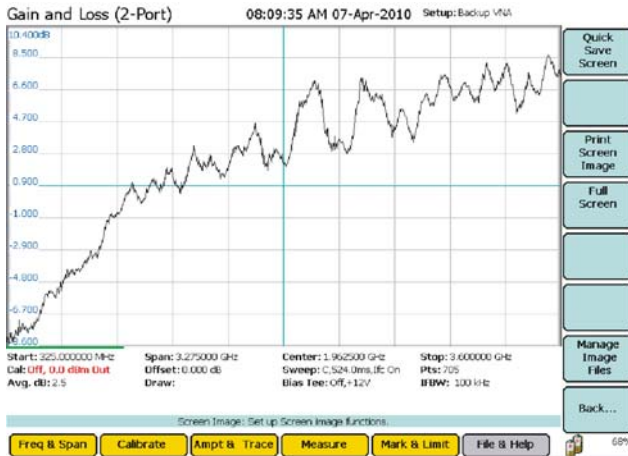
## Delete All Traces

Deletes all the traces in the directory.

## Screen Image

---

**Figure 64** Example, Screen Image



## Quick Save Screen

Saves the current trace with a standard naming convention.

**Note:** Files are saved in .bmp format with the naming convention of "ScreenDDHHMMSS.bmp".

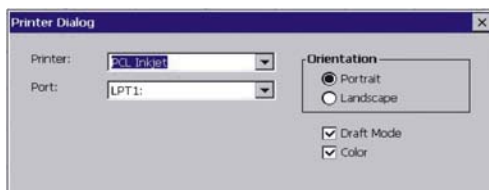
## Full Screen

Enlarges the graph area to the size of the whole screen. Press escape to go back to regular screen.

## Print Screen Image

Prints the current screen image and presents print setting options for print adjustment.

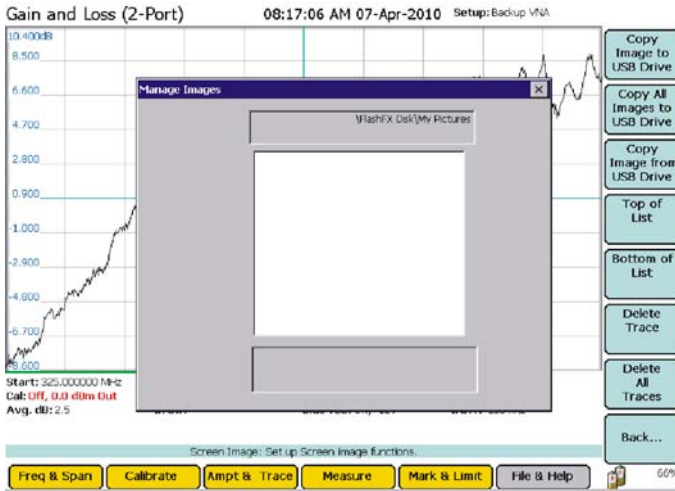
**Figure 65** Print Screen Menu



## Manage Image Files

Launches the image file manager.

**Figure 66** Manage Image Files



**Copy Image to USB Drive** - Saves selected image to the USB drive.

**Copy All Images to USB Drive** - Saves all images in the directory the USB drive.

**Copy Image from USB Drive** - Saves image to the internal memory of the SignalHawk.

**Top of List** - Selects the image listed at the top of the directory.

**Bottom of List** - Selects the image listed at the bottom of the directory.

**Delete Trace** - Deletes the selected image.

**Delete All Traces** - Deletes all the traces listed in the directory.

## Utility

---

See "Utility Main Menu" on page 126.

## Help

---

Enables various Help sections that can be accessed via the soft keys. The Help sections are listed below:

- VNA Help (with Match, DTF, and Cable Loss sections)
- Spectrum Analyzer Help
- Power Meter Help
- Custom Help

**Note:** *The DTF section of the VNA help is also accessible in the DTF measurement screen.*



Spectrum Analysis, measuring the power at each frequency in the sweep range, is the basic measurement. The other measurements interpret that data to provide useful results.

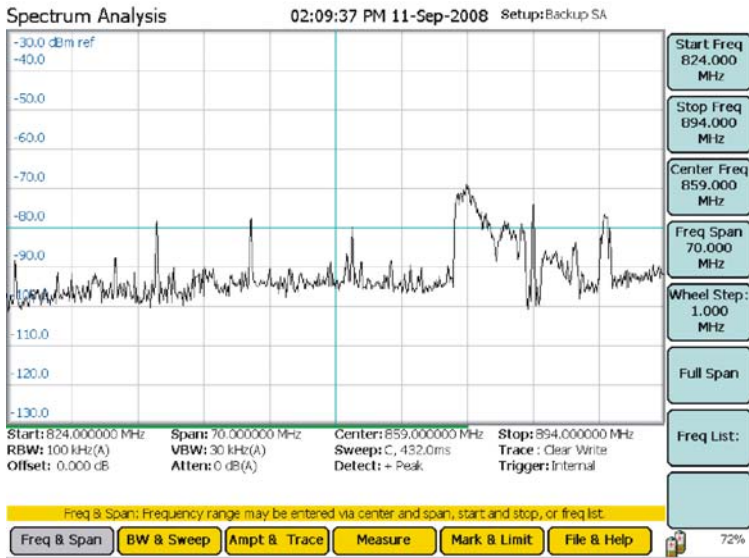
In the Spectrum Analyzer mode, the following measurements can be used:

- "Spectrum Analysis Measurement" on page 84.
- "Occupied Bandwidth Measurement" on page 85.
- "Channel Power Measurement" on page 87.
- "Adjacent Channel Power Measurement" on page 89.
- "Time Domain (Zero Span)" on page 91.
- "Field Strength Measurement" on page 92.
- "Demodulate Signal" on page 93.
- "Carrier-to-Interference Ratio" on page 94.
- "Out-of-Band and In-Band, Out-of-Channel Spurious" on page 96.
- "Water Fall" on page 72.

# Spectrum Analysis Measurement

Spectrum Analysis graphically displays signal amplitude at each frequency in the range shown on the screen.

**Figure 67** Example, Spectrum Analysis, Frequency and Span Screen



# Occupied Bandwidth Measurement

Occupied Bandwidth measures the frequency band bandwidth that contains a specified percentage of the total power of the signal.

It gives best results with single-peaked signals. Bandwidth can be defined in two ways. Both give measurement results in Hz units.

## Threshold Modes

### %

The calculated occupied bandwidth represents the user specified percent of the total power of the displayed span. Best for Watts power units.

### dBc

The bandwidth is calculated by finding the frequencies above and below the center or carrier frequency that is the user specified dB below the carrier level. This method is best for measuring dBm power units.

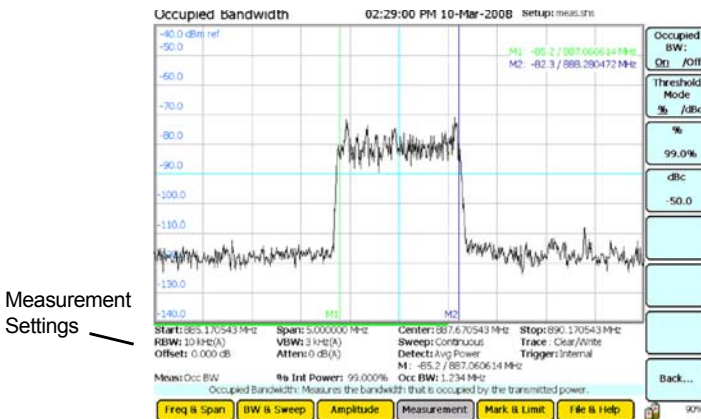
## Setting Occupied Bandwidth

**Note:** For the best accuracy, set the center frequency so the main or carrier signal is centered on the screen before taking measurements.

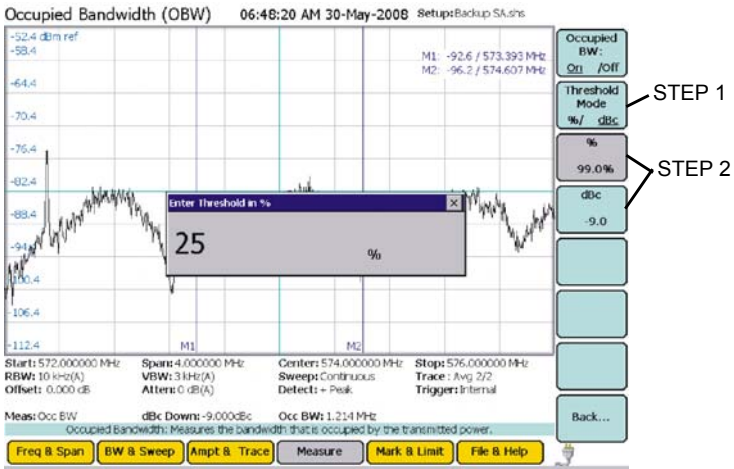
1. Select either % or dBc under Threshold Mode.
2. Do one of the following:
  - **If the % Threshold has been selected**, go the % soft key and set the desired threshold via either the thumbwheel or keypad.
  - **If the dBc Threshold has been selected**, go the dBc soft key and set the desired threshold via either the thumbwheel or keypad.

**Note:** The threshold and the measured bandwidth will be displayed in the “measurement settings” area at the bottom of the display. Markers 1 and 2 will be turned on, and placed at the band edges.

Figure 68 Example, Occupied Bandwidth

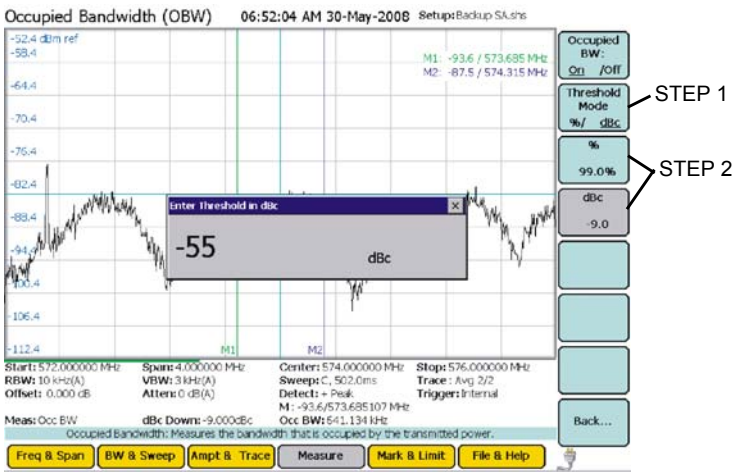


**Figure 69 Example, Occupied Bandwidth - %**



**Note:** The limit can be set without changing the Threshold Mode.

**Figure 70 Example, Occupied Bandwidth - dBc**



**Note:** The limit can be set without changing the Threshold Mode.

# Channel Power Measurement

Channel Power measures the Integration Bandwidth, the total power over a frequency range, concentrated on the center frequency of the sweep. It is useful for channelized (frequency-division multiplexed) signals. Results are shown in both total power in the channel (in dBm or Watts), and spectral density (dBm or Watts per Hz).

## Setting Channel Power

**Note:** For best accuracy, set the center frequency so the signal is roughly centered before taking measurements. In addition, the span should be  $1\frac{1}{2}$  – 5 times as large as the desired channel width.

1. Select the Integration Bandwidth (IBW).

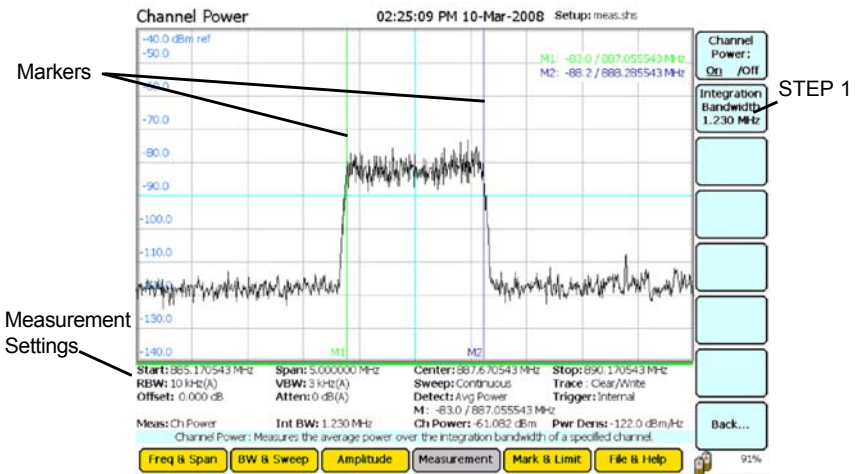
**Note:** The IBW is automatically set when a channelized frequency band is selected from the Frequency list.

2. Type in the desired bandwidth using the keypad.
3. Press the correct soft key for the desired unit.

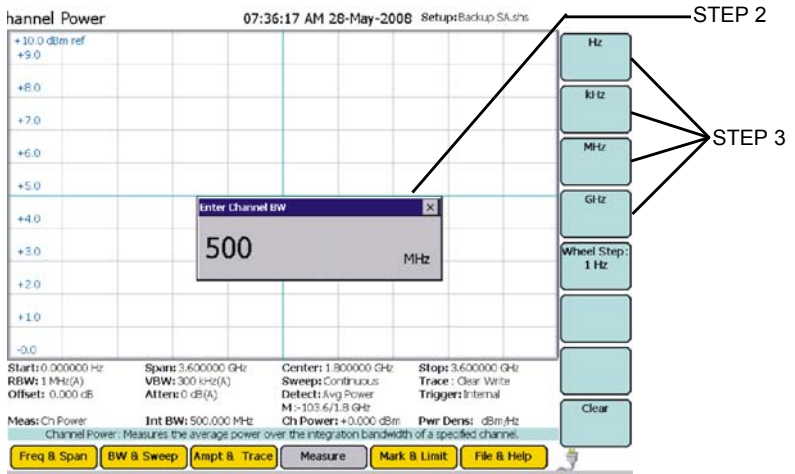
**Note:** The default unit is MHz.

**Note:** The integration bandwidth, channel power, and power density will be displayed in the “measurement settings” area at the bottom of the display. Markers 1 and 2 will be turned on, and placed at the band edges.

Figure 71 Example, Channel Power



**Figure 72 Example, Channel Power, Integration Bandwidth**



## Adjacent Channel Power Measurement

---

Adjacent Channel Power measures the relative power of frequency bands adjacent to a central channel. This is often used to identify power leakage from the center channel into the adjacent channels. The total power in the central (main) channel is displayed in dBm (Ch Power), and the power in the adjacent channels is displayed as dB below and above the main channel power (Dn ACPR and Up ACPR).

**Note:** *For best accuracy, set the central frequency so the signal is centered before taking measurements. In addition, set the span so the central, upper, and lower channels are all shown on the screen.*

**Note:** *If a channelized band is selected from the Frequency list, these parameters are automatically set.*

1. Set the width of the central channel.

**Note:** *The central channel can be set to a different frequency width than the adjacent channels, but both adjacent channels have the same width.*

2. Set both adjacent channels.
3. Set the Center-to-Center channel spacing.

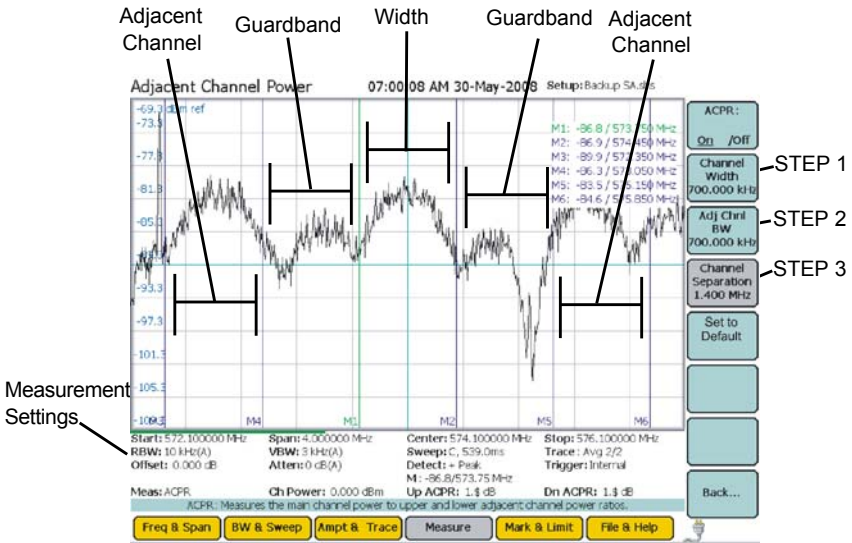
**Note:** *Channel spacing is the distance from the central channel's center frequency to the adjacent channel's center frequency. If there is no guardband between channels, the channel spacing should be half (channel width + adjacent channel width).*

4. Type the desired bandwidth in each variable using the keypad, then select the desired unit of measurement.

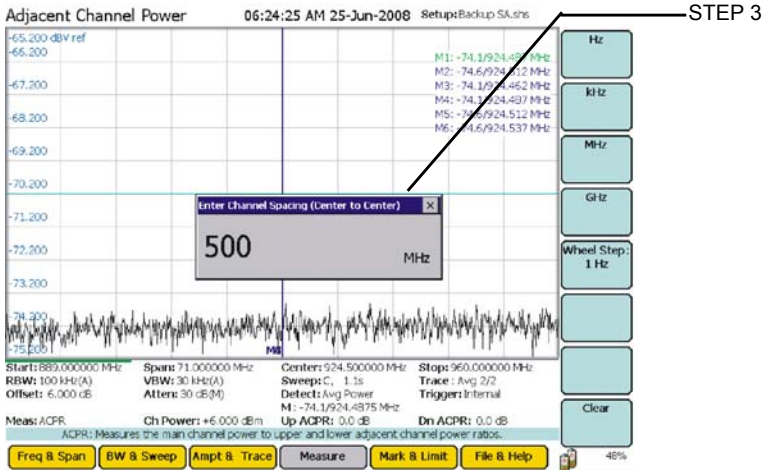
**Note:** *Pressing Enter will default the Unit to MHz.*

**Note:** *All 6 markers will be used to show the edges of the central, upper, and lower channels.*

**Figure 73 Example, Adjacent Channel Power**



**Figure 74 Example, Adjacent Channel Power, Bandwidth Settings**







# Field Strength Measurement

Field Strength measures the signals reaching an antenna. The SignalHawk automatically corrects the sweep data for the antenna's gain and frequency dependence and displays it in dBm / m.

1. Connect an antenna connected to the RF In connector on the SignalHawk.

**Note:** Use an antenna with known gain characteristics. For best accuracy, set the start and stop frequencies to the measurement range of the chosen antenna.

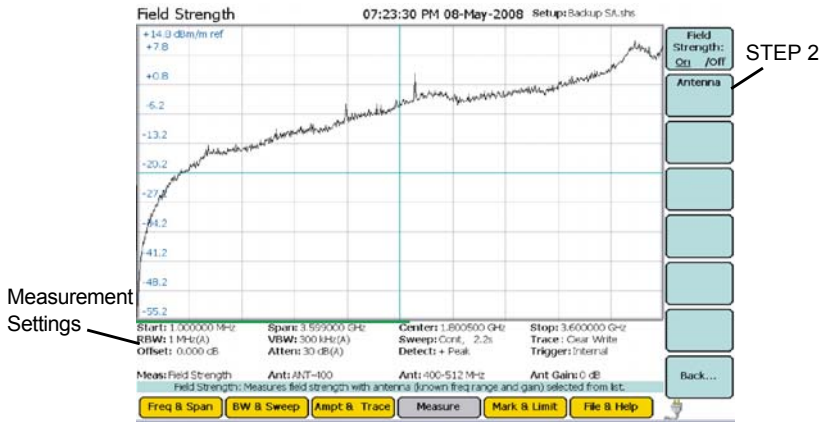
2. Press the Antenna button and select the antenna type from the drop down list.

**Note:** The antenna type, valid frequency range, and gain in dB (relative to an isotropic radiator) are shown in the measurement settings area.

**Note:** Custom antennas may be added to the list. See "Customizing SignalHawk Content" on page 129

3. Measure the strength of the signal emanating from a transmission antenna (within the frequency range of the antenna connected to the RF In port).
4. Move to various positions relative to the transmitting source and observe the signal value.

Figure 76 Example, Field Signal Strength



## Received Signal Strength Indicator (RSSI)

RSSI provides an audible indication at the frequency of the current marker. It will beep faster as the received signal strength goes up and slows as it goes down.

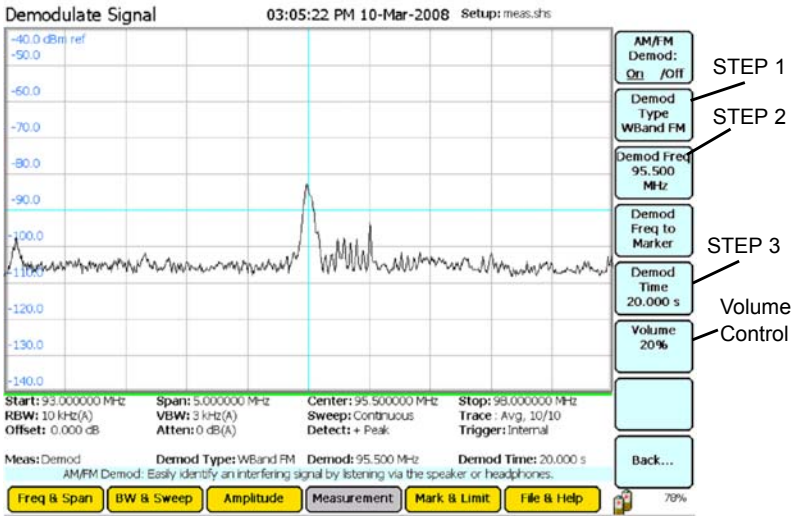
Similar to Water Fall, power is linearly mapped to a range of 0-210 using the same range as for the Water Fall for simplicity. The beep rate and volume are proportional to the mapped power value at the current marker index. Values of zero are equivalent to continuous beeps and -210 are equivalent to a beep every 4 seconds.

# Demodulate Signal

Removes the carrier and sends the signal to the internal speaker or headphones. The SignalHawk can demodulate AM, narrowband FM, and wideband FM signals. It can also set the specific frequency and volume.

1. Set the type of demodulation:
  - a. Press the Demod Type button.
  - b. Press the soft key for the type of demodulation desired.
2. Set the demodulation carrier frequency:
  - a. Press the Demod Freq button.
  - b. Enter the carrier frequency using the keypad.
  - c. Press a soft key to select the frequency units.
3. Set the time to demodulate the signal:
  - a. Press the Demod Time button.
  - b. Enter a value using the keypad.
  - c. Press a soft key to select the time units.
  - d. Allow audio to play for the demod time.
  - e. Repeat as necessary.

**Figure 77 Example, Demodulate Signal**



# Carrier-to-Interference Ratio

Calculates the ratio of the carrier signal power to the power level of the noise and interference signals.

To determine the ratio, two measurements need be done. First sweep should be the carrier and interferer. The second sweep should be the interferer alone.

**Note:** Because the transmitted carrier must be turned off for the second portion of this measurement, access to the transmitter is needed to complete this procedure.

1. Do one of the following:

- Move marker to the desired frequency.

**Note:** The default marker placement assumes the carrier to be measured is the center of the frequency span. It can be moved via the arrow keys and/or wheel.

- Press Marker to Max Peak soft key to quickly identify the signal to be measured.

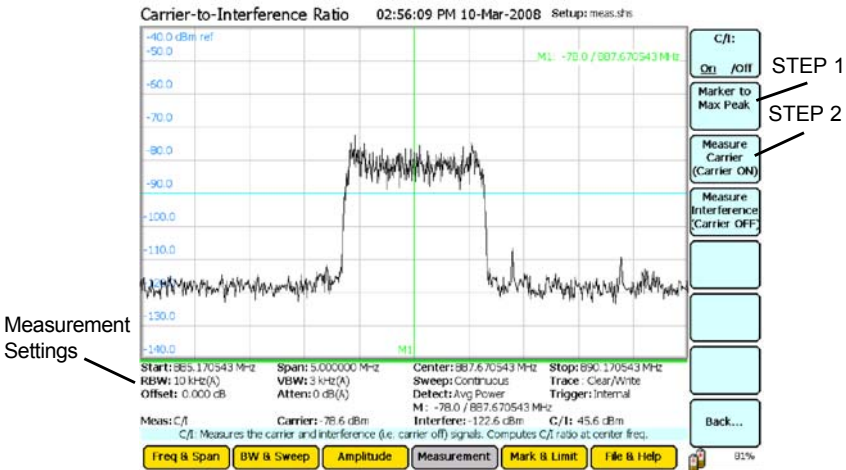
2. Measure the carrier signal.

3. Turn off the transmitter.

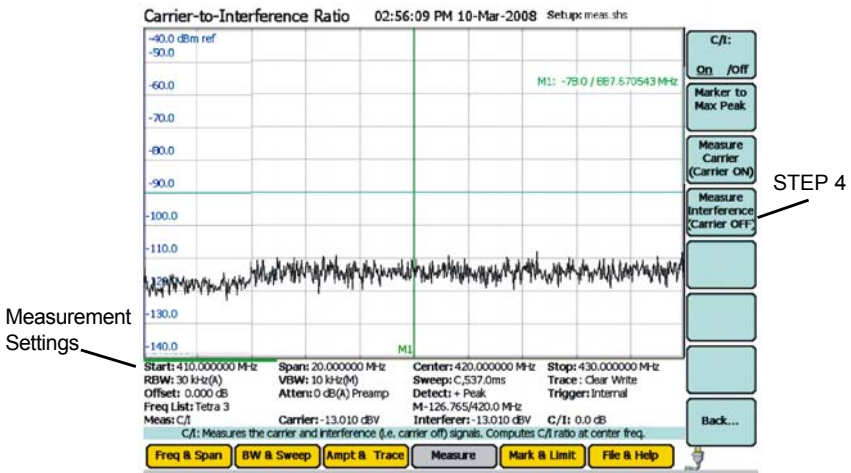
4. Measure the noise and interference signal levels as follows:

**Note:** In the status area, the carrier power and interferer power will be displayed in selected power units, and the ratio in dB.

**Figure 78 Example, Carrier-to-Interference Ratio - Carrier On**



**Figure 79 Example, Carrier-to-Interference Ratio - Carrier Off**



## Out-of-Band and In-Band, Out-of-Channel Spurious

---

**Note:** *These two measurement methods are not listed on the interface.*

Out-of-Band & In-Band, Out-of-Channel Spurious measures the distortion and interference inside or outside a system band.

1. Press the Mark & Limit key.
2. Press the Select Marker: 1 2 3 4 5 6 soft key to select marker 1.

**Note:** *The bracketed number indicates the active marker.*

3. Press the Marker: On/Off soft key.
4. Move the marker over one of the spurs using the arrow keys, the keypad or thumbwheel.
5. Compare the value of the marker to the specified allowable level of Out-of-Band or In-Band, Out-of-Channel spurious emissions for the corresponding channel transmit frequency.

Bird's SignalHawk PCTool enables the use of a PC to store measurement data, transfer it between units, and do individual analysis. Traces can be transferred from the SignalHawk to the PC and back. One or more saved traces can be opened and compared. They can also be copied and pasted into other open files, as well as adding markers or limit lines. In addition, labels can be added and modifications saved to files.

## **Computer Requirements**

---

The PC must meet the following minimum requirements:

- Windows 98 or later operating system
- Internet Explorer version 6 or later
- Hard disk with 30 MB of free space

## **Installing Windows 7 Drivers for the BTG Signal Hawk**

---

1. Download the appropriate version of Microsoft® WMDC (Windows® Mobile Device Center) from here: <http://support.microsoft.com/kb/931937>

**Note:** *You will have to go through Microsoft Genuine Advantage validation, either via ActiveX script or manually, whichever your system allows.*

2. Install WMDC on your PC.

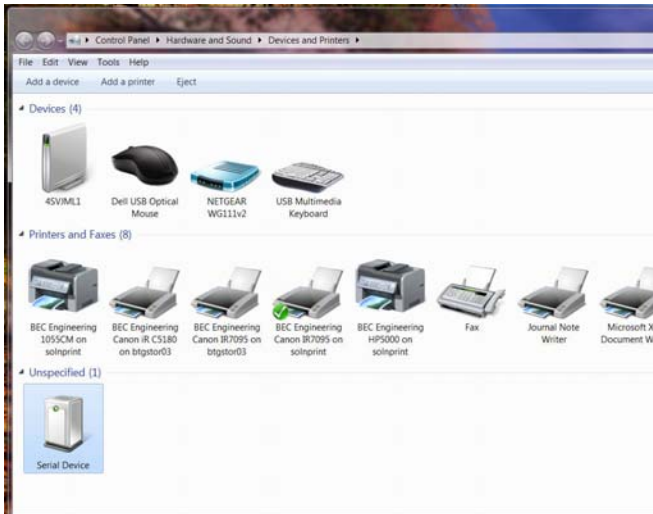
**Note:** *Do not follow Microsoft's instructions.*

3. Turn the Signal Hawk on.
4. Connect a standard A/B USB cable from the PC to the SignalHawk.

**Note:** *Windows 7 will try to install drivers but will be unsuccessful. Ignore its results.*

5. From the Start Menu, open the Devices and Printers folder.

**Figure 80** *Devices and Printers Folder*

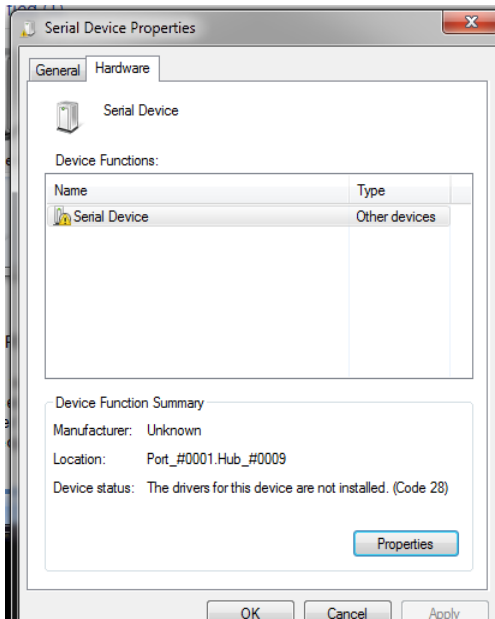


6. Select the new “Serial Device.”

**Note:** It will have a yellow “caution” triangle with an (!) in it which indicates that no driver has been installed.

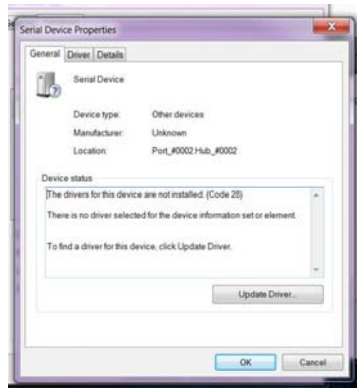
7. Select the “Hardware” tab and click on “Properties” for the “Serial Device”.

**Figure 81** *Hardware Tab*



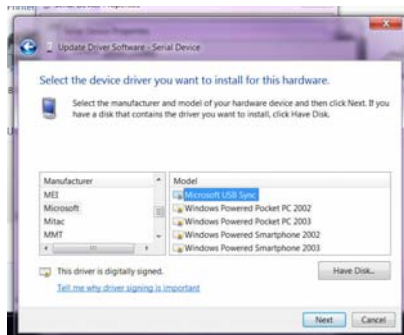


**Figure 82 Device Properties**



8. Click on the "Update Driver" button.
9. Select "Browse my computer for driver software."
10. Select "Let me pick from a list of device drivers on my computer."
11. Scroll down to "Mobile devices" and click the "Next" button.
12. In the left box scroll down and highlight "Microsoft."
13. In the right box select "Microsoft USB Sync."

**Figure 83 Mobile List**



14. Click the "Next" button.
15. Click the "Yes" button in the "Update Driver Warning" message box that appears.
16. Wait while the driver is installed.
17. A confirmation box appears indicating success. Click the "Close" button. Accept the BitsyX license terms after reading them in the pop-up.
18. The Windows Media Device Center dialog will open.

**Figure 84 Windows Mobile Device Control Screen**



19. Close the WMDC window.
20. Run the SH PC Tool to transfer traces or upgrade the Signal Hawk firmware.

## Downloading and Installing Software

---

**Note:** These files are on the CD supplied with the SignalHawk, and can also be downloaded from the website.

**Note:** For the latest versions of the PCTool, Microsoft® ActiveSync®, and USB Drivers download them from the Bird Technologies Signal-Hawk website:

<http://www.bird-technologies.com/products/software/sh/index.htm>

## Installing the SignalHawk USB Drivers

---

**Note:** The USB Drivers should be installed before the first time a SignalHawk is connected to a PC.

1. Click on “Install SignalHawk USB Drivers.”
2. Save the compressed file to the PC’s desktop.
3. Double click the compressed file on the PC desktop.
4. Click-and-drag the .inf and .sys files out of the compressed file window and onto the PC desktop.
5. Connect the SignalHawk to the PC via the USB cable.

6. Select the downloaded files on the PC desktop when prompted for the SignalHawk drivers.

## Installing the PC Tool Software

---

1. Download and install Microsoft ActiveSync.
2. Click on “Install PC Interface Tool.”
3. Save the compressed file to the PC’s desktop.
4. Double click the compressed file on the PC desktop.
5. Click-and-drag the SHPCTool icon (Setup file) out of the compressed file window and onto the PC desktop.
6. Double-click the Setup file.
7. Follow the instructions in the Install Wizard to complete the installation.

## Menu Bar

---



### File

---

Presents commands to Open, Close, Save, Export, and Print SignalHawk files that are stored on the PC.

**Note:** *By default, traces will be saved to the “My Traces”, which is a sub-folder under the folder where the PCTool was installed.*

### Edit

---

Presents commands to copy the active trace from a graph and paste it into another graph. Traces can also be deleted from a graph.

**Note:** *The last trace remaining on a graph cannot be removed.*

### View

---

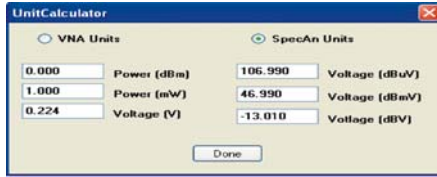
Presents commands to manipulate the trace - Zoom In, Zoom Out, Add, and Delete Markers or Limit Lines, Autoscale the Trace, Set to Normal Mode, and Set Options. Normal mode is identified by the standard Windows “selection” cursor (arrow pointing to the upper left). DTF Settings (Cable Vp & Loss, Start & Stop Distance, etc) can also be viewed.

### Tools

---

Presents access to the units converter.

**Figure 85** *Units Converter*



## Measurements

---

**Note:** *This option will only appear for VNA traces.*

Presents the various measurement types to display the reading. The types of measurement depend on the type of trace file being read. VNA files will give Match Measurement, Distance-to-Fault, Cable Loss, and Smith Chart as options.

## Communicate

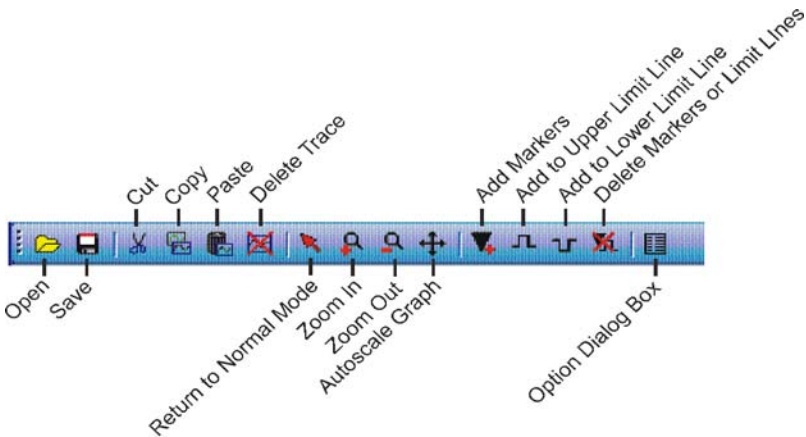
---

Presents commands to get files from and/or send files to the SignalHawk. In addition, use this function to upgrade the SignalHawk software/firmware.

## Tool Bar

---

Use the tool icons to perform the tasks that are available on the Menu bar.



## Save

---

Saves a copy of a graph.

## Open

---

Opens a graph.

## Cut

---

Cuts a trace from a graph.

## Copy

---

Copies a trace from a graph.

## Paste

---

Pastes a trace onto a graph.

**Note:** *A trace from one measurement type cannot be placed onto a graph from another measurement type (Occupied Bandwidth, Channel Power, etc). The graphs do not match.*

## Delete Trace

---

Deletes a trace from a graph.

**Note:** *The last trace on a graph cannot be deleted.*

## Return to Normal Mode

---

Returns the display back to the start menu.

## Zoom In

---

Increases the focus on a specific area of a graph.

## Zoom Out

---

Decreases the focus from a specific area of a graph.

## Autoscale Graph

---

Resizes the axis to fit all traces on the graph.

## Add Markers

---

Drops a marker onto a graph.

## Add to Upper Limit Line

---

Adds a limit line to the graph.

- First click will create a point on the graph with a highlighted line.
- Second click will create another point that connects to the first point via a line.
- Third click connects to the second, and so on.

## Add to Lower Limit Line

---

Adds a limit line to the graph.

- First click will create a point on the graph with a line.
- Second click will create another point that connects to the first point via a line.
- Third click connects to the second, and so on

## Delete Markers or Limit Lines

---

Deletes a marker, a limit line, or a point on a limit line. When deleting points, the icon will change to an eraser graphic when the icon floats over something that can be deleted.

## Option Dialog Box

---

Opens the pop-up Option Dialog box. "Options Dialog Box (View>Options)" on page 105.

## Measurement Types

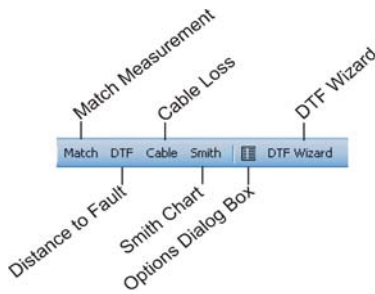
---

The measurement types for that file are displayed, depending on the type of file being read.

## VNA Tool Bar

---

**Note:** *There is an addendum, with additional options, to the menu bar when the PC Tool is reading a VNA file.*



## Match

---

Sets the current trace to a Match measurement display.

## Distance to Fault

---

Sets the current trace to a Distance to Fault display.

## Cable

---

Sets the current trace to a Cable Loss display.

## Smith

---

Sets the current trace to display a Smith Chart.

## Options Dialog Box

---

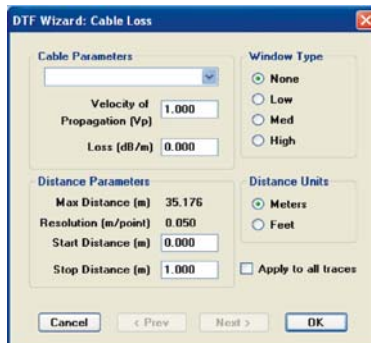
Opens the pop up Option Dialog box. "Options Dialog Box (View>Options)" on page 105.

## DTF Wizard

---

Opens the Distance to Fault Wizard.

**Figure 86** DTF Wizard



## Options Dialog Box (View>Options)

---

The Options dialog box contains six tabs - Scale, Units, Markers, Limits1, Limits 2, and Labels. Select a tab and enter or edit specific values for the currently active graph.

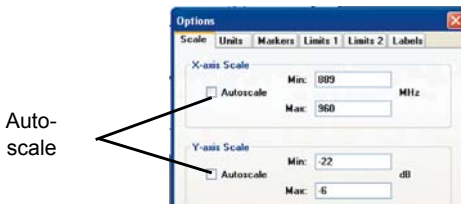
## Scale Tab

---

1. Enter the x- and y- axis.
2. Enter the y- axis offset.
3. Do one of the following:
  - Select the Autoscale box.
  - Manually enter values for the scales.

**Note:** *The Offset setting for a specific trace is displayed. The setting changes when the Trace changes.*

Figure 87 Example, Scale Tab



## Units Tab

---

1. Select the units of measure for the y axis.
2. Set the size of text for the entire graph.
3. Set whether or not to display grid lines.

Figure 88 Example, Units Tab



## Markers Tab

---

When a frequency or distance for a marker is entered, the marker will be set to the datapoint closest to that frequency or distance. The actual frequency of the marker will replace the value entered and will also display on the screen below the graph area.

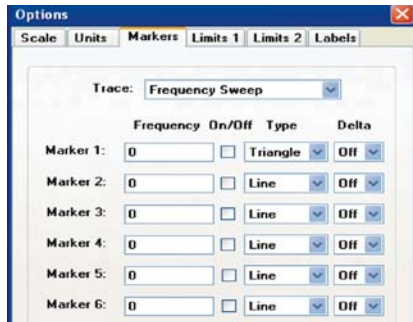
### For each marker:

1. Specify or change the frequency.
2. Specify the symbol type.
3. Specify a delta with another marker.
4. Turn a marker on or off.

**Note:** After turning a marker on in the Options window, the marker can be moved by clicking on the marker and dragging it to a desired location.



Figure 89 Example, Markers Tab



## Limits 1 Tab

Defines and turns on or off upper/lower limit lines.

**Note:** The options displayed on this tab will change slightly depending on the type of graph opened.

**Note:** The upper limit fails any datapoints that are above the line.

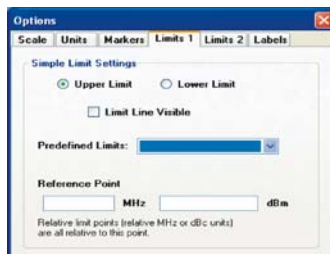
**Note:** The lower limit fails any datapoints that are below the line.

**Note:** The limit line will be flat across the graph at the power level specified.

1. Click on the line
2. Drag the line to move it up and down.

**Note:** There is a drop down menu of predefined limits that is available to be utilized.

Figure 90 Example, Limits 1 Tab



## Limits 2 Tab

**Note:** The options displayed on this tab will change slightly depending on the type of graph opened.

**Note:** The upper limit fails any datapoints that are above the line.

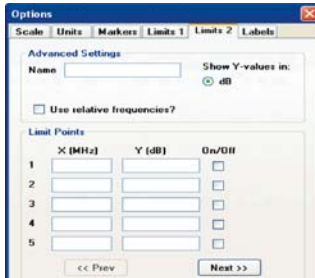
**Note:** The lower limit fails any datapoints that are below the line.

**Note:** Up to thirty points, for both upper and lower limit lines can be set up. Using multiple points, a bracketed area may be created.

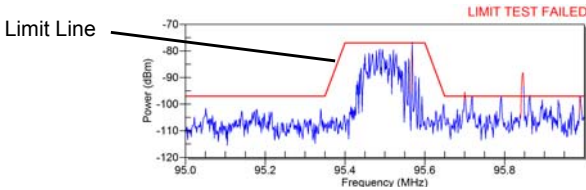
1. Click on a segment
2. Drag each segment at its set point to move it up or down.

**Note:** If a limit line point is disabled, it is removed from the list in the Options dialog box.

**Figure 91 Example, Limits 2 Tab**



**Figure 92 Multiple limit line points used to create a bracketed area**



## Labels Tab

Creates a title, subtitle, and a trace name for the displayed trace.

The title will be in larger letters and centered above the graph. The subtitle will be smaller.

Edit a trace name by typing in the list of traces on this tab. The trace and date will be located above the graph and on the left.

**Note:** If a specific trace name is not created, the PC tool will create one automatically.

Other options are to display or hide the title, subtitle, trace name, and trace date on the graph.

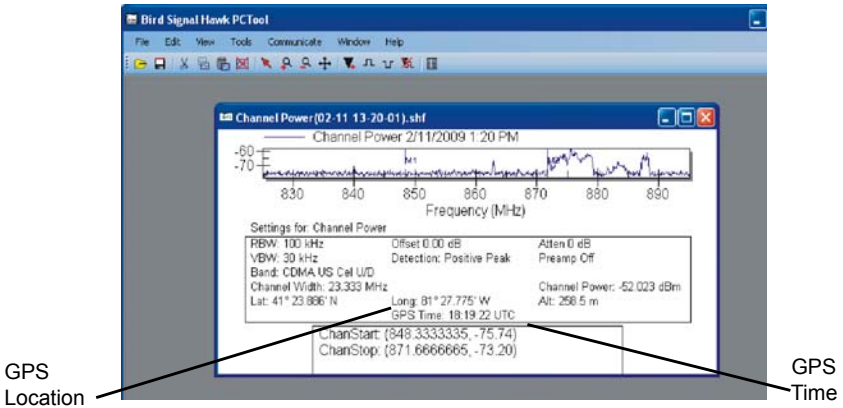
**Figure 93 Example, Labels Tab**



# GPS

If a GPS sensor is attached to the SignalHawk, it will display a location and GPS time reading at the bottom of the trace.

**Figure 94** GPS Reading





Power measurements verify and monitor the condition of a transmitter system. To measure transmitter power, connect an external power sensor to a transmitter system then to the SignalHawk and select the Power Meter mode from the Start Menu screen. Power sensors that are compatible with the SignalHawk are the Bird Directional Power Sensors (model 5010B), Terminating Power Sensors (model 5011), Extended Frequency Terminating Power Sensors (model 5011-EF), and Wideband Power Sensors (models 5012B, 5016B, 5017, 5018B and 5019B).

The Power Meter mode has the following features:

- Displays numerical readout.
- Display Forward Power, Reflected Power, Match Efficiency, Peak Power, Burst, and Crest Factor depending upon the capabilities of the sensor.
- Display power measurements in Watts or dBm.
- Display match units in VSWR, Return Loss, or % Match Efficiency.

**Figure 95** *SignalHawk Compatible Sensors*



## Quick Setup - Configure Sensor and Instrument

---

1. With power turned off, connect a communication cable from the SignalHawk RS-232 port to an external power sensor.
2. Turn the SignalHawk on.
3. Press Power Meter menu key at the Start Menu.
4. Select External Power Sensor from the list, and press Enter.

**Note:** *The SignalHawk will acquire the power sensor, this may take a few moments.*

5. Press Configure menu key.
6. Do one of the following:

### **For Directional Power Sensors (Model 5010B):**

1. Press the soft key to select the type of element.
2. Press Forward Scale soft key then use the up and down arrow keys to enter the power rating of the forward element.
3. Press F/R Scale 10:1 Ratio soft key to select ON.
4. Press Input Offset soft key and use the key pad to enter the amount of attenuation.
5. Press Enter key.

### **For Terminating Power Sensors (Models 5011 and 5011-EF):**

1. Press Power: Watts soft key.
2. Press Input Offset soft key and use the key pad to enter the amount of attenuation.
3. Press Enter key.

### **For Wideband Power Sensors (Models 5012B, 5016B, 5017B, 5018B & 5019B):**

1. Press Input Offset soft key and use the key pad to enter the amount of attenuation then press the Enter key.
2. Press soft key to select Auto Duty Cycle.
3. Press soft key to select Auto Range.

## Connecting a Sensor

---

### **CAUTION**

SignalHawk test ports are not used for power measurement.  
Always use an external sensor!

### **CAUTION**

Always turn off the SignalHawk before connecting or  
disconnecting a sensor.

1. Connect a power sensor to the SignalHawk serial port “RS-232” with a 9-pin serial cable.
2. Select the Power Meter option on the Main Menu screen.

**Note:** Once the sensor is connected, the menu option has been selected, and the SignalHawk has detected it, the display will change to the sensor screen.

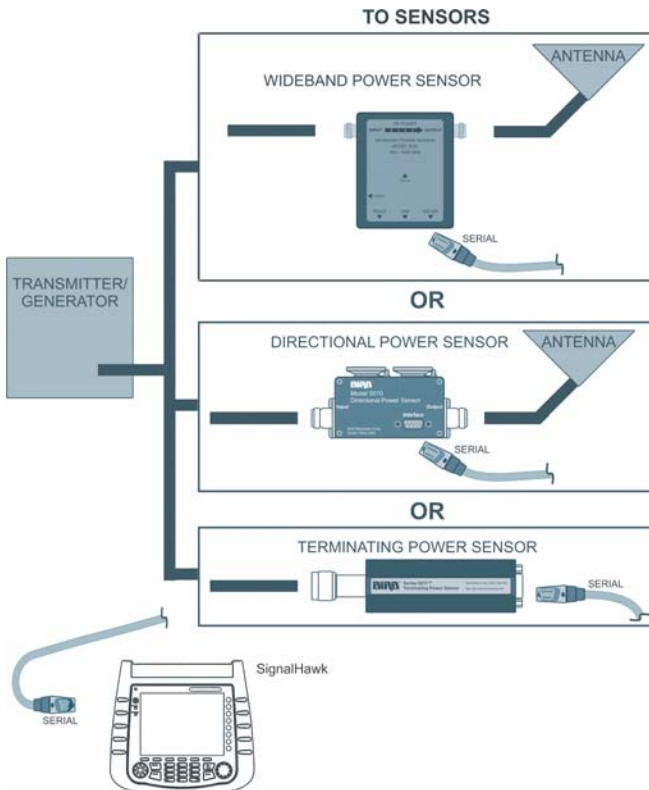
**Note:** If no power sensor is detected, the Power Meter screen displays the message “Power Sensor cannot be acquired.”

**CAUTION**

+20 dBm (100 mW) max. RF input for the Spectrum Analyzer  
and +22 dBm (160 mW) max. RF input for the Vector  
Network Analyzer.

Exceeding the maximum input will damage the SignalHawk.  
If unsure of power levels, measure the test connection with a  
power sensor before using the SignalHawk.

**Figure 96** Connecting a Power Sensor to the SignalHawk

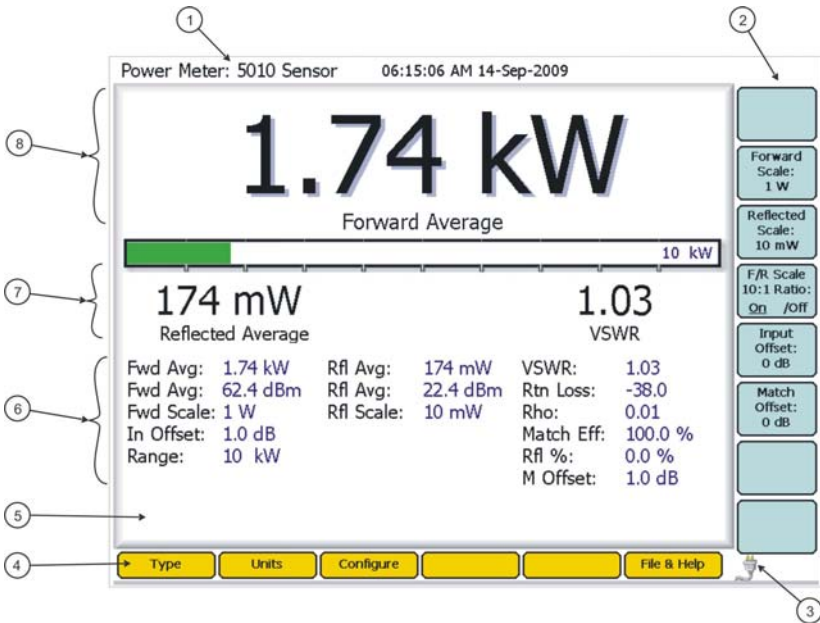


## Looking at the Screen

When the SignalHawk is connected to an external power sensor, the available commands will vary according to the capabilities of the sensor being used. Typical functions are for selecting the type of measurement, type of element, units of measure, measurement scales, offset values, and zeroing the sensor.

When a power sensor is properly connected (and detected), the status message, located at the top of the Power Meter screen, will indicate the model number of the power sensor (i.e., Bird model number).

**Figure 97 Power Sensor Initial Screen**



Item	Description
1	Model of connected power sensor
2	Soft Key Labels
3	Power Supply
4	Menu Label Keys
5	Sensor Help Text
6	Sensor Readings
7	Power Display
8	Main Power Display



## Directional Power Sensor Measurements

---

**Note:** *The forward element's power rating must be entered before taking data.*

1. Connect the sensor. See "Connecting a Sensor" on page 112.
2. Press the Forward Scale soft key then use the Up and Down arrow keys to enter the wattage value of the forward element.
3. Press the Type menu key, then press the Forward Average soft key.

**Note:** *The Forward Average value displays in large characters at the top of the screen.*

4. Select the desired measurement to display.

## Terminating Power Sensor Measurements

---

1. Connect the sensor. See "Connecting a Sensor" on page 112.
2. Press "Start Zero Calibration" soft key to Zero-calibrate the sensor. See "Zero" on page 116.

**Note:** *The 5011 should be zero-calibrated before taking measurements. Do not apply RF to the sensor during calibration. Optional if measuring higher powers. For additional information, refer to the owner's instruction book for the TPS.*

**Note:** *Wait for the calibration to finish before continuing.*

3. ONLY if the 5011 is connected to the system through a coupler or attenuator, press the Input Offset soft key, in the Configure menu, and use the key pad to enter the amount of attenuation. See "Configure" on page 120.

## Wideband Power Sensor Measurements

---

### WARNING

Never attempt to connect or disconnect RF equipment from the transmission line while RF power is being applied.  
Leaking RF energy is a potential health hazard.

1. Connect the sensor. See "Connecting a Sensor" on page 112.
2. Select one of the following options:

**Note:** *A separate power supply for the WPS is not required when using a SignalHawk.*

**Filter: Full** - Selects a video filter value. Narrowing the filter limits noise contributed by interference signals. Select one of three filter values: Full (10 MHz), Medium (400 kHz), or Low (4.5 kHz). See "Configure" on page 120.

**Note:** *For additional information about video filtering, refer to the owner's instruction book for the WPS.*

**Duty Cycle** - Measures the signal duty cycle. Select Auto or Manual, the default setting is Auto. See “Configure” on page 120.

**Note:** *For additional information about duty cycle, refer to the owner’s instruction book for the WPS.*

**Manual Duty Cycle** - Allows use of the key pad to enter the duty cycle percent. See “Configure” on page 120.

**Note:** *Use this feature if the duty cycle is known and if the burst is less than 10 W.*

**CCDF Limit (Complimentary Cumulative Distribution Function)** -

Allows use of the key pad to enter a wattage limit for CCDF. See “Configure” on page 120.

**Note:** *Set the limit before selecting the CCDF Measurement Type.*

**Note:** *For additional information about CCDF, refer to the owner’s instruction book for the WPS.*

**Range Select** - Select the range for the bar graph display. The range is from 100  $\mu$ W to 1 MW and Auto in the following sequence: Auto, 100  $\mu$ W, 1 mW, 10 mW, 100 mW, 1 W, 10 W, 100 W, 1 kW, 10 kW, 100 kW, 1 MW, 150 mW, 1.5 W, 15 W, and 150 W. The default is Auto. See “Configure” on page 120.

## Menu Keys and Associated Soft Key Functions

---

### Zero

---

Starts a zero calibration of a sensor.

**Note:** *For additional information, refer to the owner’s instruction book for the sensor.*

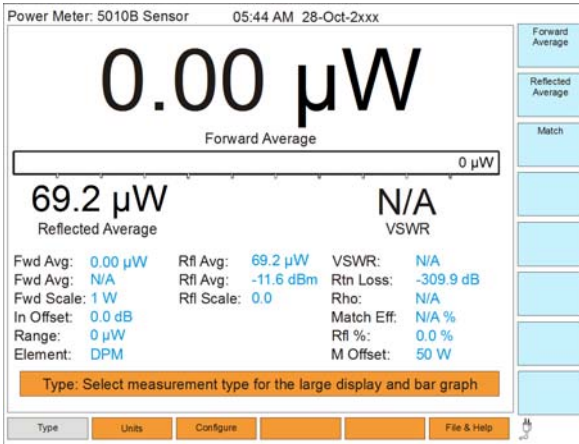
### Type

---

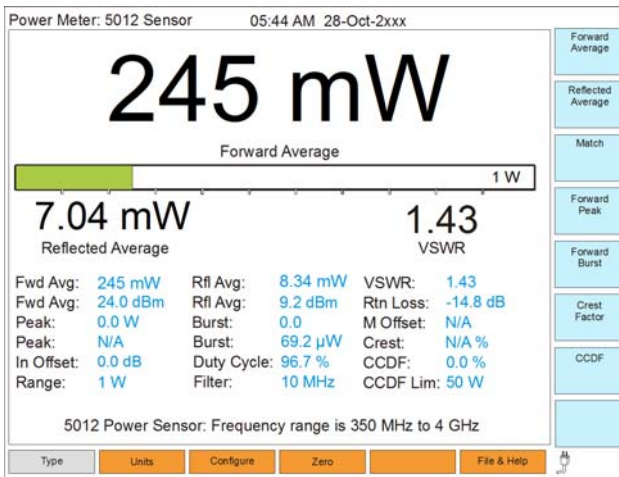
**Note:** *Specific measurement types depend upon the power sensor being used (Figure 98, Directional sensor or Figure 99, Wideband sensor). Not all power sensors have the Type selection option.*

Soft key functions that select the primary measurement to be made (such as forward average power, reflected average power, match) are enabled. The selected measurement will be displayed in large characters above the bar graph. The remaining measurements will display in smaller characters below the bar graph. If one of the measurements is not available or does not apply to the current application, it will be identified as N/A (not applicable) in the Sensor Readings area of the screen.

**Figure 98 Power Meter, Digital Display, Type Screen (Directional sensor)**



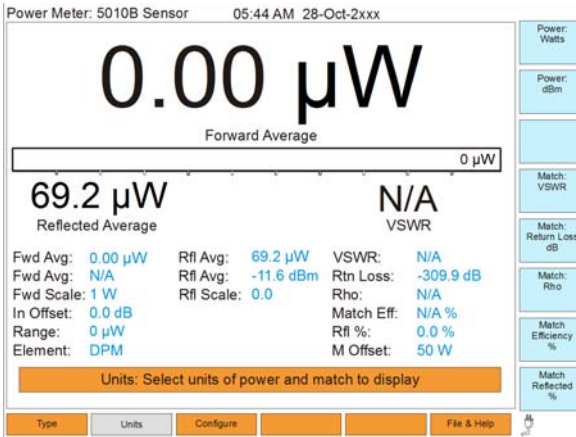
**Figure 99 Power Meter, Digital Display, Type Screen (Wideband sensor)**



## Units

Soft key functions that select the units of measure (Figure 100) are enabled. For power measurements, Watts or dBm can be selected. For match measurements, VSWR, dB, rho, and percent (%) can be selected.

**Figure 100 Power Meter, Digital Display, Units Screen (Directional sensor)**



**Note:** The Units screen applies to Directional and Wideband Power sensors only.

### Power: Watts

Measures power in Watts.

$$Power(Watts) = 10^{\Lambda}((dBm - 30)/10)$$

### Power: dBm

Measures power in dBm.

$$Power(dBm) = 10 \times \text{Log}[Power(Watts)] + 30dB$$

### Match: VSWR

Measures match, a complex ratio of reflected power to forward power expressed in VSWR.

$$VSWR = [1 + \text{Sqrt}(Pr/Pf)]/[1 - \text{Sqrt}(Pr/Pf)]$$

**Note:** "Pr" = Reflected Power, "Pf" = Forward Power

### Match: Return Loss dB

Measures match, a complex ratio of reflected average power to forward power expressed in dB.

$$ReturnLoss(dB) = 10 \times \text{Log}(Pr/Pf)$$

### Match: Rho

Measures match, a complex ratio of reflected power to forward average power expressed in Rho.

$$Rho = \text{Sqrt}(Pr/Pf)$$

### Match Efficiency %

Measures match, a complex ratio of reflected power to forward power expressed in percent efficiency.

$$\text{MatchEfficiency(Percent)} = 100 \times (1 - (Pr/Pf))$$

### Forward Average

Measures the forward average power.

$$Pf(\text{dBm}) = 10 \times \text{Log}(Pf(\text{Watts})) + 30\text{dB}$$

### Reflected Average

Measures the reflected average power.

$$Pr(\text{dBm}) = 10 \times \text{Log}(Pr(\text{Watts})) + 30\text{dB}$$

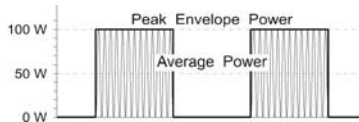
### Match

Measures the match between the transmitted forward average power and the reflected average power.

$$\text{MatchEfficiency(Percent)} = 100 \times (1 - (Pr/Pf))$$

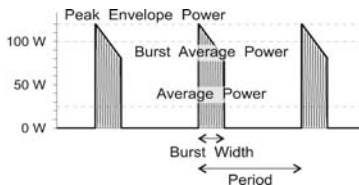
### Forward Peak

Measures the forward peak envelope power.



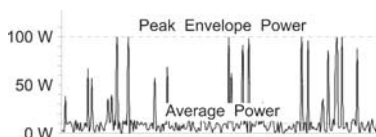
### Forward Burst

Measures the average power of a transmitted pulse.



### Crest Factor

Measures the difference between the peak power and the average power.



## CCDF (Complimentary Cumulative Distribution Function)

Measures the amount of time that the power is above a pre-defined limit (the CCDF Limit).



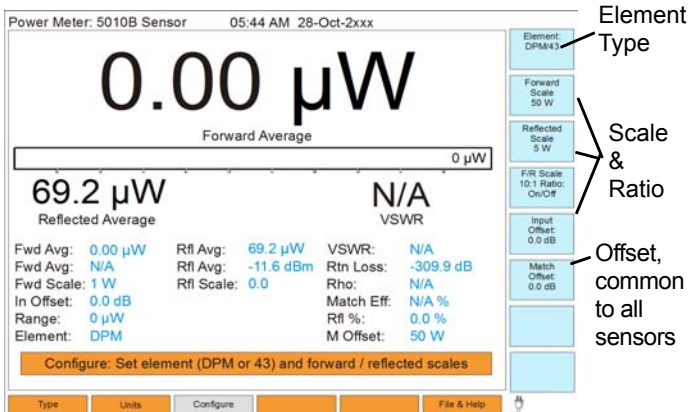
**Note:** These features are available only with the Bird Wideband power sensor. For additional information about Forward Burst, Crest Factor, and CCDF, refer to the operations manual for the Bird Wideband Power Sensor.

## Configure

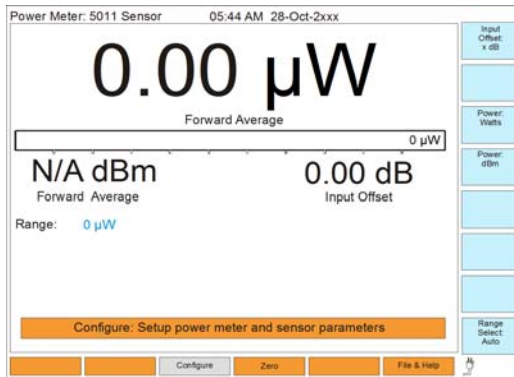
**Note:** Specific configuration features depend upon the power sensor being used (Figure 101 5010B sensor, Figure 102 5011 sensor, Figure 103 5012B, 5016B, 5017B, 5018B, and 5019B sensors).

The soft key functions that specify the setup information about the sensor and the measurements are enabled. The following are displayed at this time: type of element in the power sensor, the offsets for input and match, duty cycle, and the scale for forward and reflected power.

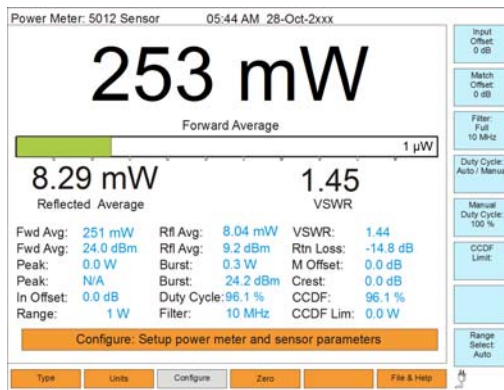
**Figure 101 Power Meter, Digital Display, Configure Screen (Directional sensor)**



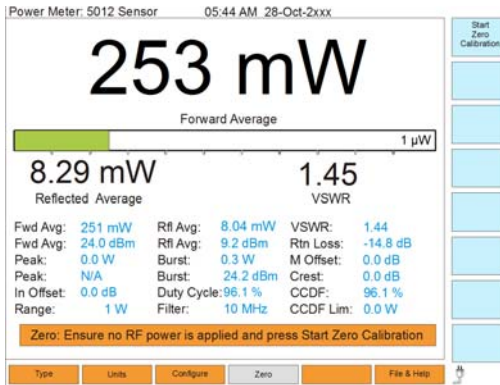
**Figure 102 Power Meter, Digital Display, Configure Screen (Terminating sensor)**



**Figure 103 Power Meter, Digital Display, Configure Screen (Wideband sensor)**



**Figure 104** Power Meter, Digital Display, Zero Screen (Wideband sensor)



## Quick Setup - Zero a Sensor

1. Check that no RF is in the system.

**Note:** The sensor will read approximately "0."

2. Press the Zero menu key.
3. Press the Start Zero Calibration soft key.

**Note:** Some soft key features will not be available for certain power sensors.

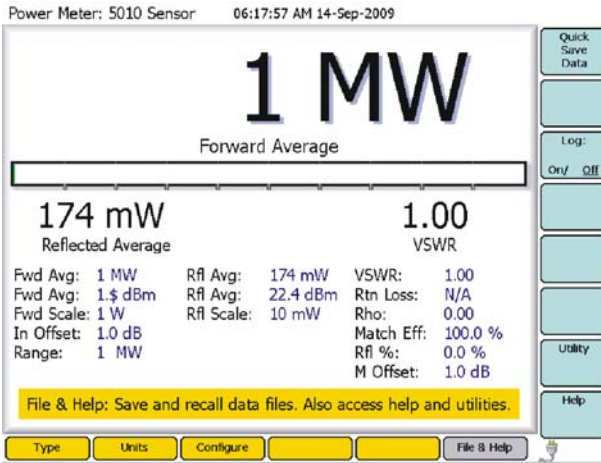
## File & Help

The soft keys for saving the current trace, selecting the utility option, activating the logging feature, and accessing help features (Figure 105) are enabled.

A trace is saved as a file and stored in the internal memory of the instrument. Using the PCTool utility that is supplied on the CD that ships with the Signal-Hawk, stored files can be copied or moved from the internal memory to an external storage device.



**Figure 105 Power Meter, Digital Display, File & Help Screen (typical soft keys for all sensors)**



## Quick Save Data

Saves the data that is displayed on the screen. The saved data is stored as a file in the internal flash drive of the instrument. Each quick save is stored in a separate file that is named using the date-time file naming format *PwrYYYYMMDDHHMMSS.csv* where YYYY is the year, the first MM is the month, DD is the day, HH is the hour, the second MM is the minute, and SS is the second of the time when the file was saved. The data files can be viewed by any software program that can read a comma separated value (.csv) format (such as a spreadsheet).

Using the PCTool utility supplied on the CD that ships with the instrument and ActiveSync (version 4.2 or later), stored files can be copied or moved from the internal memory to an external storage device (thumbdrive, PC, etc).

**Note:** Download the latest version of ActiveSync at the Microsoft web site.

## Log: On / Off

---

Activates or deactivates the internal logging feature.

When logging is On, a thin line appears under the word On on the soft key text. When logging is Off, a thin line appears under the word Off.

Logging captures and stores the set of data that is sent from the external power sensor and displayed on the screen. While logging is On, each set of data is stored as text on a separate line in the same computer file. The speed of the logging depends on the type of sensor being used (e.g., a 5011 will record a data every 300 ms).

Logging stops when the Log: On / Off soft key is pressed. The log file is named using the date and time file naming convention *PwrYYYYMMDDHHMMSS.csv* where YYYY is the year, the first MM is the month, DD is the day, HH is the hour, the second MM is the minute, and SS is the second of the time when the file was saved.

When the logging feature is On, there is a choice to log (store) every data set received or one set from a group. Press the up or down arrow keys to change the number of data sets to store:

- 1 of 1 - store every data set received
- 1 of 10 - store every tenth data set received
- 1 of 100 - store every one-hundredth data set received
- 1 of 1000 - store every one-thousandth data set received

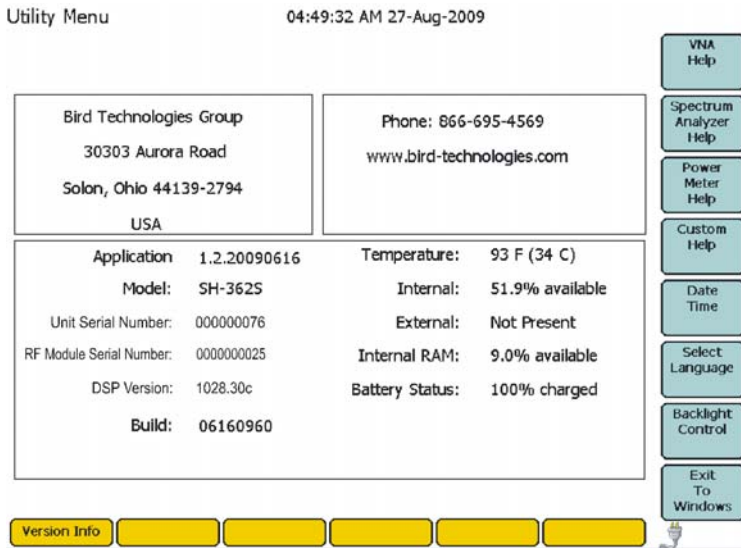
With SignalHawk’s built-in utilities, information about the instrument is displayed. The Menu keys provide information about the software, hardware, and data files.

Utilities can be accessed by pressing the Utilities menu key from the Start Menu screen, or by pressing the File & Help menu key from a measurement screen then pressing the Utility soft key. To exit the Utility mode, press the Esc/Back function key to return to the previous screen, or press the Mode key to go to the Start Menu screen.

**Utilities**

Press this soft key to go to the Utility Menu. When the utility menu is accessed, new menu keys and soft keys for getting help, setting the date and time, adjusting the backlight brightness, and exiting to the Windows operating system are activated. The Utility Menu screen displays status information about the instrument and about the operating system.

**Figure 106 Utility Menu, Main Screen, Version Info Screen**



# Utility Main Menu

---

## Version Info

---

View general information such as how to contact Bird Technologies Group.

The soft keys for this menu selection provide access to VNA Help, Spectrum Analyzer Help, Power Meter Help, Custom Help, Date and Time, Select Language, Backlight Control, and Exit to Windows.

## VNA Help

---

Procedures and specifications for the Vector Network Analyzer feature of the SignalHawk.

## Spectrum Analyzer Help

---

Procedures and specifications for the Spectrum Analyzer feature of the SignalHawk.

## Power Meter Help

---

Procedures and specifications for the Power Meter feature of the SignalHawk.

## Custom Help

---

Displays user created help files that have been uploaded to the SignalHawk.

### Installing Custom Help Files

1. Connect the SignalHawk to the PC via the USB cable.

**Note:** *The SignalHawk may have to be disconnected and reconnected a couple times to activate the ActiveSync connection. A message should confirm connection.*

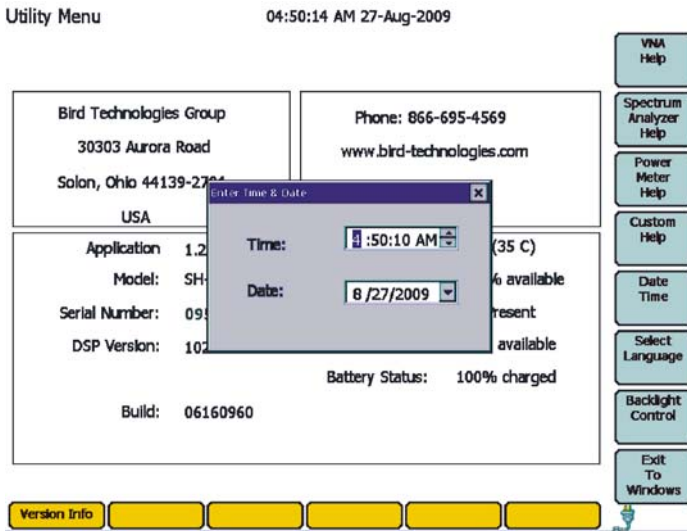
2. Navigate to the Mobile Device icon.
3. Access the FlashFX Disk\Help directory.
4. Copy the “custom” text file to the PC.
5. Update the “custom” text file with customized text.
6. Copy the “custom” text file back into the Help directory on the SignalHawk.
7. Click “Ok” when the PC requests permission to overwrite the old text file.
8. Close the directory on the PC.
9. Disconnect the SignalHawk from the PC.

## Date Time

---

Displays a dialog box showing the date and time (Fig. 107). Use the up-and-down arrow keys or the key pad to increase or decrease the selected value. Use the right-and-left arrow keys to move to the next or previous component of time or date. Use the thumbwheel to move between the Time and Date data fields. Press the Enter key to exit the dialog box and return to the Utility Menu screen. The new time and date is displayed at the top of the screen.

**Figure 107** Utility, Set Time and Date



## Select Language

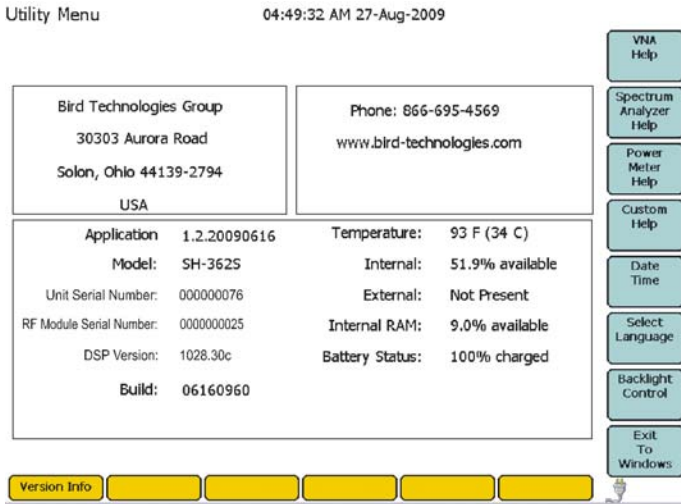
---

Allows access to change the language of the user interface.

## Backlight Control

Displays the backlight options (Fig. 108). Press the Esc/Back function key to return to the previous screen.

**Figure 108 Utility, Backlight Options Screen**



Backlight Soft Key	Function
Backlight Mode Auto / Man	Set the backlight brightness Auto - adjusted by internal circuitry Man - set by user
Backlight High	Manual - Set backlight to brightest intensity.
Backlight Medium	Manual - Set backlight to middle intensity (default setting - provides approximately 5.5 hr. battery life).
Backlight Low	Manual - Set backlight to lowest intensity (provides approximately 7.5 hr. battery life).
Backlight Custom xx%	Manual - Set backlight to a specific percent intensity between 0 (off) and 100 (brightest).
Sensor Gain	<b>For Backlight Auto Mode Only:</b> Sets a threshold where the ambient light sensor increases the backlight Low threshold - Backlight intensity increases after a small change in ambient light. High threshold - Backlight intensity increases after a large change in ambient light.

## Exit to Windows

---

Exits the SignalHawk program and goes into the Windows shell.

## Customizing SignalHawk Content

---

1. Go to the Utilities menu.
2. Press the Exit to Windows soft key.

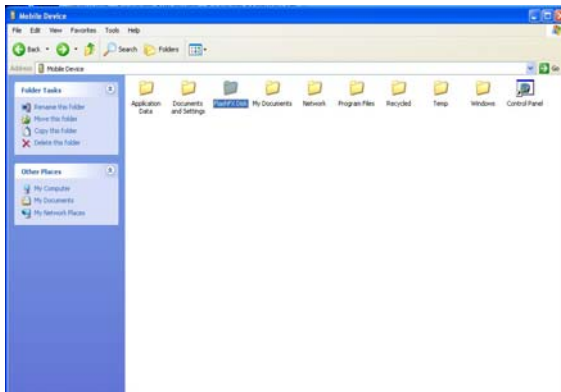
**Note:** *The SignalHawk will ask for verification.*

**Figure 109** *Utility, Exit to Windows*



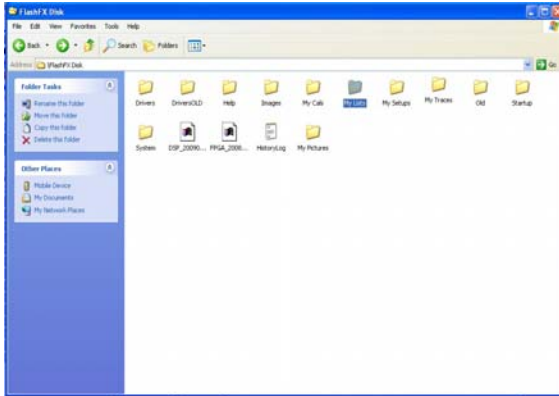
3. Connect the SignalHawk to a PC via a USB cable.
4. Go to My Computer on the PC.
5. Go to Mobile Device.

**Figure 110** *SignalHawk Root Directory*



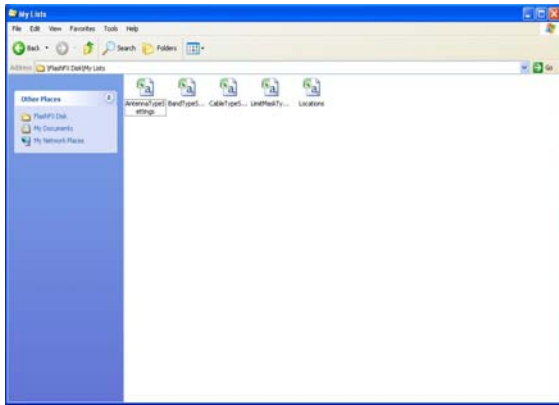
6. Go to FlashFX.

**Figure 111** *FlashFX Directory*



7. Go to My Lists.

**Figure 112** *My Lists Directory*



8. Copy the csv file of the list to be edited to the desktop of the PC.
9. Open the csv file.
10. Add custom information into the list.
11. Copy the csv file back into the FlashFX directory.

**Note:** *The computer will ask for verification to overwrite the file in the directory.*

12. Close the FlashFX directory window.
13. Select Bird SignalHawk on the SignalHawk.



Regular maintenance is essential for proper and accurate performance of the SignalHawk. These procedures cover the basic maintenance of the SignalHawk. For more advanced issues, please contact Bird Technologies customer service.

## **Cleaning**

---

**CAUTION**

Harsh or abrasive detergents, and some solvents, can damage the display unit and labels.

Clean the Bird SignalHawk only with a soft cloth dampened with mild detergent and water. Do not use any other type of cleaning solution.

## **Discharging Static Electricity**

---

Touch the element to a safe grounded material.

**WARNING**

Care should be taken when handling objects with built up static electricity. Electrical shock may occur.

## **Charging the Battery**

---

The internal battery pack will automatically recharge when the SignalHawk is powered from the AC or cigarette lighter adapter. Recharging time, from a full discharge, is approximately 4 hours.

## **Upgrading the Software/Firmware**

---

Both the firmware and software are updated on a regular basis. The operator's manual covers the most recent upgrade to the firmware up to the date listed on the manual. Yet, not all SignalHawk models have the current revision of the firmware or software. Please upgrade both the firmware and software to obtain the most current revision.

## PC Procedure

---

1. Install the PCTool.
2. Go to <http://www.bird-technologies.com/products/software/sh/>.
3. Select "Install SignalHawk Application Software/Firmware Upgrade."
4. Download and Save the latest software/firmware package from Bird's website.  
**Note:** *Follow the instructions on downloading the file.*
5. Unzip the downloaded file to the PC's desktop.  
**Note:** *A new folder containing more folders inside it should be created.*
6. Turn on the SignalHawk.
7. Connect the SignalHawk to the PC via the USB cable.  
**Note:** *The SignalHawk may have to be disconnected and reconnected a couple times to activate the ActiveSync connection. A message should confirm connection.*
8. Navigate to the Utilities menu on the SignalHawk and select Exit to Windows.
9. Run the PCTool.
10. Click on the Communicate menu.
11. Select "Upgrade Firmware".
12. Navigate to the PC desktop, open the unzipped folder, and select the sub-folder located there. Click OK.  
**Note:** *If the unit is connected, click OK at the "Make sure your unit is connected" message.*
13. Wait for the upgrade to complete.  
**Note:** *This may take a moment.*
14. Cycle the power on the SignalHawk.
15. Open the "Mobile Device" icon in My Computer once the upgrade is complete.
16. Navigate to the FlashFX disk folder.
17. Open the unzipped software/firmware upgrade folder in a separate window.
18. Locate the DSP\_xxx.bin and FPGA\_xxx.bin files in the upgrade folder.  
**Note:** *They will be located in the unzipped folder> software/firmware version subfolder> Images sub-folder.*
19. Click-and-drag the .bin files to the FlashFX folder.  
**Note:** *Select Ok at the "File Conversion" window.*

## SignalHawk Procedure

---

1. Navigate to the Utilities Menu.
2. Press “Exit to Windows” under the Utilities Menu.
3. Use the arrow keys to highlight the SignalHawk Diagnostics application on the SignalHawk desktop.
4. Press Enter to start the operation.
5. Press the “Digital Board” key.
6. Press the “Update FPGA” key.
7. Navigate to the FPGA\_xxx file (under “FlashFX Disk”) and select it.
8. Press Enter to start the operation.
9. Press Enter at each confirmation message until the Diagnostic Application exits.

**Note:** *This may take a moment.*

10. Restart the Diagnostic Application.
11. Press the “Digital Board” key.
12. Then the “Update DSP” key.
13. Navigate to the DSP\_xxx file (under “FlashFX Disk”) and select it.
14. Press Enter to start the operation.
15. Press Enter at each confirmation message until the Diagnostic Application exits.

**Note:** *This may take a moment.*

16. Reboot the SignalHawk.

## Replacing the Battery

---

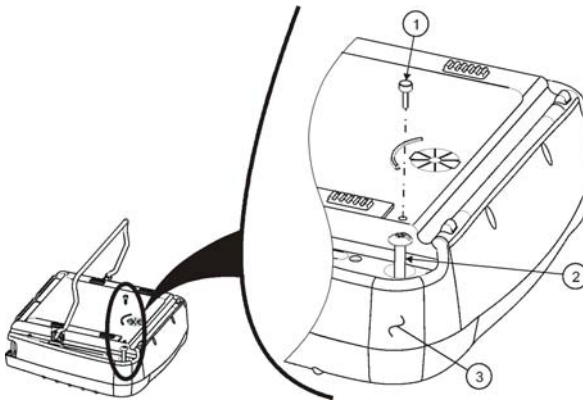
### WARNING

Care should be taken when handling batteries.  
Keep out of the reach of children.  
Do not heat or dispose of batteries in fire. May burst or release toxic materials.  
Avoid forced discharge.  
Do not short circuit.  
Restrict charging current and time to the recommended value.  
Do not solder the battery directly.  
Do not disassemble, apply excessive pressure, or deform.  
Avoid placing the battery in reverse polarity.  
Battery disposal method should be in accordance with local and state regulations.

1. Lay the instrument, display side down, on a clean non-abrasive surface.
2. Remove the two screws and the battery cover. Refer to Figure 113, page 135.  

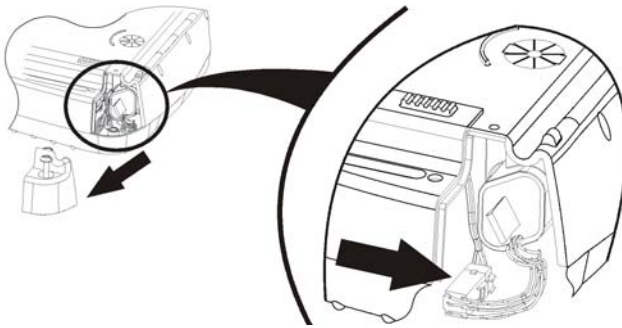
**Note:** *The large screw in the battery cover is a captive screw that does not separate from the cover.*
3. Disconnect the battery cable connector (Figure 114, page 135).
4. Remove the old battery pack, using the pull-tab, from the battery compartment (Figure 115, page 135).
5. Insert the new battery into the battery compartment.
6. Connect the battery cable to the new battery.
7. Replace the battery cover and secure the two screws.
8. Connect the AC adapter to the unit.
9. Apply power to the unit and verify that it operates properly.
10. Charge the battery if needed.

**Figure 113 Removing Battery Cover Screws**

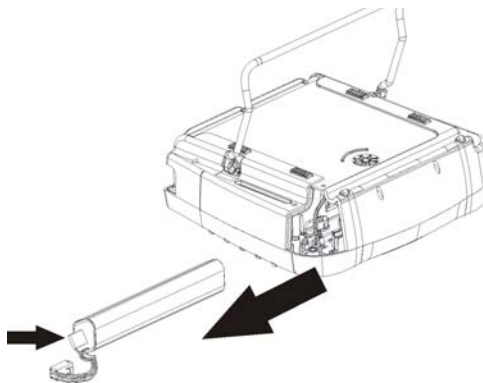


Item	Description
1	Battery cover screw, removable
2	Battery cover screw, captive
3	Battery cover

**Figure 114 Battery Connector**



**Figure 115 Removing the Battery**



## Troubleshooting

Any service procedure not covered in this manual should be referred to an authorized service facility.

### For All Models

Problem	Possible Cause	Possible Correction
Unit will not power up.	Battery pack drained.	Charge the battery pack. See "Charging the Battery" on page 131.
	Battery pack unable to keep a charge.	Replace battery pack. See "Replacing the Battery" on page 134.
	AC adapter is damaged.	Replace the AC adapter.
Battery Light blinking	Battery cable has become dislodged.	Return the unit for service.
Self test fails.	Error condition.	Turn off power, wait 15 seconds, then turn power back on. If the problem persists, return the unit for service.
Keys do not respond.	Unit is "Locked Up".	Turn off power, wait 15 seconds, then turn power back on.
Unit beeps and turns off.	Internal error.	Turn off power, wait 15 seconds, then turn power back on.
	Unit was last shut down because the battery was too low to operate the unit.	Plug in AC adapter and operate the unit from the AC power.
Unit operates erratically.	System has become unstable.	Turn off power, wait 15 seconds, then turn power back on.
Unit ceases to operate (locks up).	System has become unstable.	Turn off power, wait 15 seconds, then reapply power.
Sweep is too slow.	Bandwidth set too low.	Increase Bandwidth. See "Setting Occupied Bandwidth" on page 85.
Sweep stopped.	Sweep set to single-sweep or external trigger.	Set unit to continuous sweep. See "Sweep More" on page 65.
	Unit is "Locked Up".	Turn off power, wait 15 seconds, then turn power back on.

### For Vector Network Analyzer Only

Problem	Possible Cause	Possible Correction
Fault Location trace appears incorrect.	Incorrect cable loss or velocity of propagation.	Check Cable Loss and $V_p$ settings. See "Vp (Velocity)" on page 51 and "Loss" on page 52.
Trace drifts outside of specifications.	Calibration lost.	Calibrate the unit immediately before making a measurement. See "Calibrate Menu" on page 27.
Sweep is too slow.	Number of points too high.	Decrease number of points. "Data Points" on page 30.

## For Spectrum Analyzer Only

Erratic antenna test measurements.	Bad calibration combo.	Use a different calibration standard.
------------------------------------	------------------------	---------------------------------------

## Specifications

### SignalHawk Models

Model Number	Model Name
SH-362S	2-Port VNA (1.6 MHz to 3.6 GHz) and Spectrum Analyzer (100 kHz to 3.6 GHz)
SH-361S	1-Port VNA (1.6 MHz to 3.6 GHz) and Spectrum Analyzer (100 kHz to 3.6 GHz)
SH-362	2-Port VNA (1.6 MHz to 3.6 GHz)
SH-36S	Spectrum Analyzer (100 kHz to 3.6 GHz)

### For Spectrum Analyzer Models SH-362S, SH-361S and SH-36S

Frequency	
Range	100 kHz to 3.6 GHz
Resolution	1 Hz
Uncertainty	$\pm 1$ ppm ( $2\sigma$ ) of measured frequency
Aging	$\pm 1$ ppm / year ( $2\sigma$ )
Temperature drift	$\pm 1$ ppm / °C ( $2\sigma$ )
Span	1 kHz to 3598.4 MHz; 0 Hz (zero span)
Spectral Purity, Max @ 1 GHz	
30 kHz from carrier	-85 dBc / (RBW Hz) <sup>1/2</sup>
100 kHz from carrier	-100 dBc / (RBW Hz) <sup>1/2</sup>
1 MHz from carrier	-124 dBc / (RBW Hz) <sup>1/2</sup>
Sweep Time:	2.2 to >2000 s, full span; 1 ms to 100 s, zero span (Time Domain)
Displayed Data Points	705
Resolution Bandwidth (RBW):	100 Hz to 1 MHz in 1, 3, 10 steps
Video Bandwidth (VBW):	10 Hz to 300 kHz in 1, 3, 10 steps

Amplitude	
Display Range	-150 dBm to +30 dBm
Intermodulation-Free Dynamic Range	66 dB; Third-order IM products, Two -20 dBm inputs, Reference = -10 dBm
Displayed Average Noise Level	-135 dBm; 24 dB gain, 100 Hz RBW, 10 Hz VBW, average detection

<b>Amplitude</b>	
Inherent Spurious	-80 dBm; reference $\leq -10$ dBm, $f > 30$ MHz, RBW $\leq 100$ kHz
Input Related Spurious	-70 dBc; mixer level $\leq -30$ dBm, carrier offset $\geq 1$ MHz
Accuracy	$\pm 1.5$ dB max (2 $\sigma$ ), $\pm 1.0$ dB typical, $> -50$ dB ref, 15 to 35 °C, max detector
Reference Level	-140 to +30 dBm
Attenuator	Built-in: 0, 10, 20, 30 dB, Auto
Pre-Amp	Built-in: +24 dB
Resolution dB-based units W or V-based units	1 to 15 dB per division in 1 dB steps 1%, 2%, 5%, or 10% of reference level per division
Units Power Field Strength	dBm, dB $\mu$ V, dBmV, dBV, V, W dBm/m, dB $\mu$ V/m, dBmV/m, dBV/m, V/m, W/m
Offset Range	-99 to +99 dB
Detection Modes	Positive peak, negative peak, sample, average
Trigger Modes Trigger Sources External Trigger Types  External Trigger Level External Trigger Delay External Trigger Connector	Continuous, single Internal, external TTL, internal video Rising edge, falling edge, any edge, trigger on HIGH, trigger on LOW TTL Levels User-settable, 100 $\mu$ s to 1000 ms after trigger received before starting sweep BNC(F)

<b>Input</b>	
Connector	Precision N-F
RF Input Impedance	50 ohms, nominal
RF Input VSWR	1.8:1 typ, 2.0:1 max (internal attenuator = 10dB or greater)
Max DC Input	$\pm 50$ V
Max RF Input	+20 dBm; damage level is +30dBm for 30 sec.

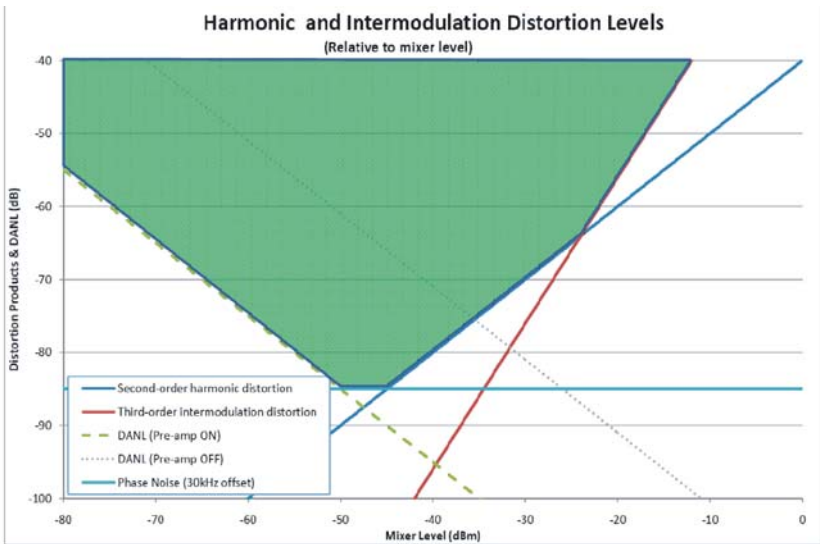
<b>Measurements</b>	
Overview	Analyzes radio frequency spectrum. Measures intended and interfering signals. Allows setup of parameters such as frequency, amplitude, and markers. Graphically displays signals amplitude vs. frequency and saves traces.



## Measurements

Predefined Measurements	Spectrum Analysis, Occupied Bandwidth (OBW), Channel Power, Adjacent Channel Power Ratio (ACPR), Field Strength, Time Domain, AM/FM Demodulation, Carrier-to-Interference Ratio (C/I), and Water Fall Spectrogram. Emission Masks for broadcast, LMR, and WiMax applications. Out-of-Band Spurious and In-Band, Out-of-Channel Spurious measurements.
-------------------------	---

**Chart I - Distortion & DANL**



**For Vector Network Analyzer (Models SH-362S, SH-362, & SH-361S Only)**

Frequency	
Range	1.6 MHz to 3.6 GHz
Resolution	40.323 kHz
Accuracy	$\pm 10$ kHz or $\pm 10$ ppm whichever is greater
Span	100 kHz – 3.6 GHz
Span	100 kHz to 3598.4 MHz
Sweep Time	<0.6 sec 705 points, reflection measurement, IF BW 1MHz <0.6 sec 705 points, thru measurement, IF BW 1MHz
Measurement Points	12,23,45,89,177,353,705,1409,2817,5633,11265 Calibrated at point counts 705 and above
IF Bandwidth:	100 Hz to 3 MHz in 1,3,10 steps

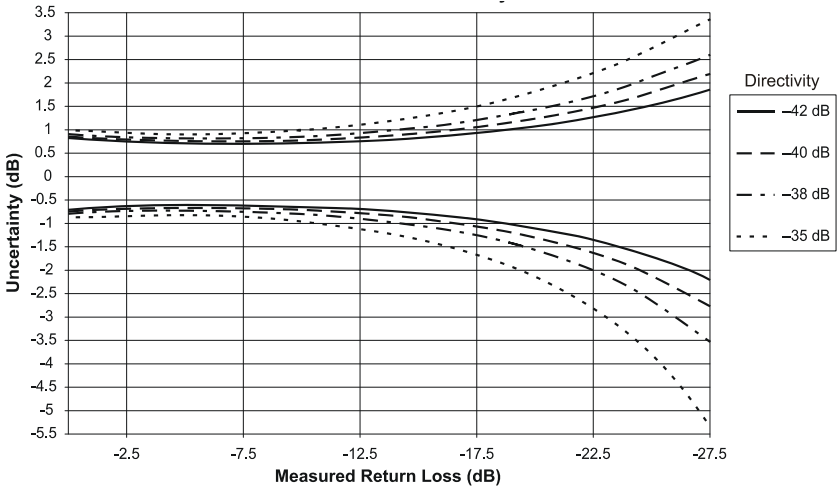
<b>Amplitude</b>	
Measurement Range	
Return Loss, Cable Loss	-60 to 0 dB
VSWR	1.0 to 99.99
Rho	0.0 to 1.00
Distance to fault (Max)	1500 m, software limited
Insertion Loss, Gain	-90 to +50 dB (1.6 MHz – 3.6 GHz)
Measurement Resolution	
Return & Cable Loss	0.1 dB
VSWR, Rho	0.01
Distance to fault (min.)	4 cm (1.6")
Insertion Loss, Gain	0.1 dB
Corrected Directivity, using Bird Cal. Kit	
Directivity	-42 dB
Phase	3°
Instrumentation	-35 dB
Open/short	≤ 0.09 dB
Measurement Accuracy	
Return, Cable loss	<+/-1.5 dB, measurements 0 to -20 dB, corrected directivity = -42dB. See "Chart II - Return Loss Uncertainty, 1.6MHz to 3.6GHz" on page 142.
VSWR, Rho	Calculated from Return Loss.
Distance to Fault	
Distance	+/- 2% of full-scale range with Vp=1.
Fault	Same as for Return Loss.
Gain	<+/- 1.0dB, measurements 0 to +30 dB, measured device S11 and S22 =0. See "Chart II - Return Loss Uncertainty, 1.6MHz to 3.6GHz" on page 142.
Insertion Loss	<+/- 1.0 dB, measurements 0 to -40 dB, measured device S11 and S22 =0. See "Chart III - Insertion Loss/Gain Uncertainty, 1.6 MHz to 3.6 GHz" on page 142.

<b>Test Port Input</b>	
Impedance, Nominal	50 ohms
VSWR (Max.)	2.75:1
Output Power (nominal)	-40 to +10 dBm, 10 dB steps, user-settable, +/-5dB
Max RF Input	+22 dBm
Immunity to Interference	+13 dBm at desired measurement frequency

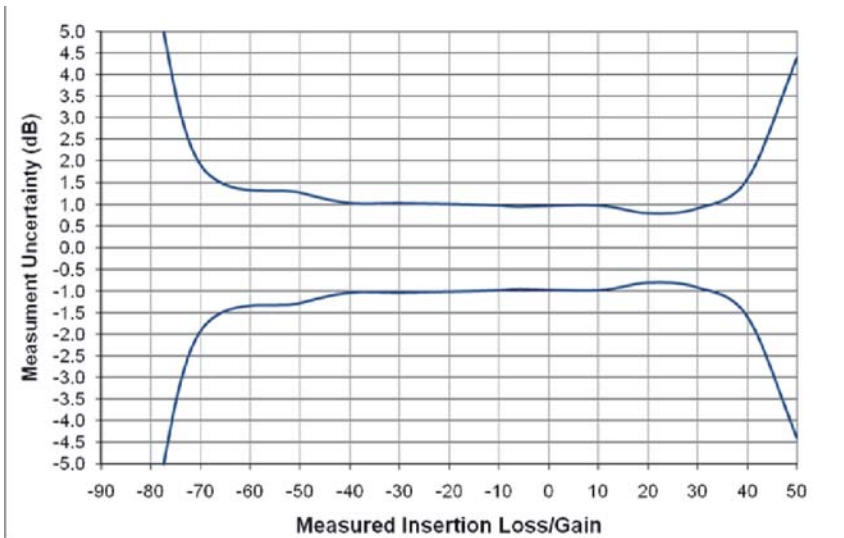
<b>Thru Port Input</b>	
Impedance, Nominal	50 ohms
VSWR (Max.)	1.5:1
Max RF Input	+22 dBm
Bias Tee (on Thru port)	AISG TMA DC Supply Class 1 and Class 2
DC Voltage, Nominal	12V or 24V, user-selectable
Current Supply	0-800 mA, 1A surge, 12V 0-400 mA, 0.5A surge, 24V
Current Measurement Activity	±5%
Immunity	
Test Port	+13 dBm
Thru Port	+13 dBc or +13 dBm Max interferer, whichever is less

<b>Measurements</b>	
Overview	Analyzes VSWR and Return Loss (dB) of single-port devices. Measures antenna and cable performance. Provides immunity to interference. Allows setup of parameters such as frequency, amplitude, and markers. Graphically displays amplitude vs. frequency and saves traces.
Predefined Measurements	Return Loss, VSWR, Match, Cable Loss, Distance to Fault, Insertion Loss, Gain, DC Bias Current Draw
DTF Cable List	Includes Vp and loss/freq parameters for 100+ cable types, user may update cable list as needed.
Markers	6 Markers; Modes: On/Off, Standard, Marker to Max Peak, Marker to Next Peak, Marker to Min Valley, Marker to Next Valley, Marker Delta, Marker Display, Marker Type Line/Icon, All Marker to Max Peaks, All Markers to Min Valleys, All Markers Off, Marker to Max/Min Peak via Up/Down Arrow Keys, Marker Left/Right via Left/Right Arrow Keys, and Wheel.

**Chart II - Return Loss Uncertainty, 1.6MHz to 3.6GHz**



**Chart III - Insertion Loss/Gain Uncertainty, 1.6 MHz to 3.6 GHz**



**General Specifications**

Model	Name: SignalHawk Model: SH-36S, SH-361S, SH-362, and SH-362S Component: Spectrum Analyzer, 1-Port Vector Network Analyzer, and 2-Port Vector Network Analyzer
Housing	PC/ABS housing, rubber over-mold and shock-mounted hardware.

## General Specifications

Display	8.4" diagonal (34 sq in), TFT, LCD, full color, SVGA, 800 x 600 pixels, 120 dpi, dual-backlight, viewable indoors and outdoors
Ambient Light Sensor	Ambient light sensor automatically adjusts display backlight when in auto backlight mode.
Keypad	Single-piece integrated unit is sealed to protect against water. In addition, it protects against impacts to display.
Buttons	Power On/Off Mode Setup Enter Escape/Back keys Left, right, up, and down arrow keys Thumbwheel 6 yellow soft keys along bottom of display 8 blue soft keys to right of display 12-key numeric keypad (0-9.+/-)
Power Indicator	Green LED labeled "Power". On continuously when operating.
Charge Indicator	Amber LED labeled "Charge". Slow blink rate (2.5 s) when charging battery. On continuously when battery fully charged. Rapid blinking when battery disconnected, failed or wall adapter problem.
Audio	Internal speaker and external headphone
Connectors	N(F) for RF input 2.5mm DC Jack for AC adapter/charger external power USB Type A for USB drive and accessories USB Type B for PC connection RS-232 DB-9(F) for external power sensors BNC(F) for external trigger (Spectrum Analyzer models) 3.5mm for mini-headphone RJ-45 LAN jack for factory diagnostics only
Lanyard Connect	Two reinforced features for attaching a lanyard and/or other quick attach/release connector. Reinforcing supports > 10 lbs.
Stand	Stand can open to angles of 15°, 45°, 180°, or close flat. May use as desk/bench top stand, carry handle, or hook hanger.

## General Specifications

Soft Carry Case	Includes 2 carry handles, shoulder strap, cover flap with clear pocket (insert quick start card), zippered back pocket (insert quick start manual, etc.), 2 clear connector covers (hook-and-loop back for access and forward for weather protection, antenna may protrude between covers), and detachable accessory pouch with 3-snap cable holder.  <b>Note:</b> <i>Do not block air flow intake (round opening on back).</i>
Connector Cover	May attach to further protect connectors from weather. Not required under normal conditions. Consists of 2 flaps and a bar. Attaches with 2 screws and 4 prongs on connector panel.
AC Adapter/Charger	External DC power supply, 15 VDC, 5 A (65 W) max, 2.5mm pin connector
Internal Battery	Rechargeable, field replaceable, lithium-ion battery. 8.8 A-hr capacity, 5.5 hours continuous operation, extends to 7.5 hours with display backlight on low, 25°C.
Warm-Up	Specifications apply after a 30-minute warm-up period at ambient temperature. Typical values are provided for reference and are not guaranteed.
Operating Temperature	0 to 50 °C (MIL-PRF-28800F, Class 3)
Storage Temperature	-20 to +80 ° <b>Note:</b> <i>If storing above 60°C for prolonged periods it is recommended that the battery be stored separately.</i>
Humidity, Max	95% non-condensing (MIL-PRF-28800F, Class 2)
Altitude, Max	4600m above sea level (MIL-PRF-28800F, Class 2)
Weight, with battery, Max	7.8 lbs
Dimensions, Max	11.5 x 10.5 x 3.8 inches (29.2 x 26.7 x 9.6 cm)

## General Specifications

CE Compliance	<p>EN 61326-1:2006 – Part 1,  EN 61326-2-1:2006 – Part 2-1  EN 6100-4-2:1995, A1:1998 &amp; A2:2001 inclusive,  Directive 2004/108/EC Relating to Electromagnetic  Compatibility  Standard: EN 61326-1:2006 Electrical equipment for  measurement, control and laboratory use - EMC  requirements - Part 1: General requirements (IEC 61326-  1:2005)  Meets level B criteria for all test except EN 6100-4-2,  Section 2 ESD immunity test, meets level C.  Directive 2006/95/EC on low voltage  Standard EN 61010-1:2001 Safety requirements for  electrical equipment for measurement, control, and  laboratory use — Part 1: General requirements (IEC  61010-1:2001)  Federal Register CFR 47, Part 15, subpart B: 2005,  Class A  ICES-003, Rev. 4:2004, Category II Equipment, Class A</p>
Electrostatic discharge (ESD)	This equipment is not specified to operate in an environment where it may be subjected to an ESD voltage spike directly on the metal portion of the enclosure.
Drop Tested	1 meter drop in most severe position per EN 61010-1
Transit Drop	10 drops on corners and faces per MIL-PRF-28800F, Class 2
Bench Handling	4 drops on each face per MIL-PRF-28800F, Class 2
Vibration	Random 10 to 500 Hz per MIL-PRF-28800F, Class 2
Shock, Functional	30 G half-sine shock pulse per MIL-PRF-28800F, Class 2
Drip Proof	Water flow 16 liters per hour per MIL-PRF-28800F, Class 2
Salt Exposure	Salt fog tested for 48 hours, constantly wetted with 5% salt solution at 35°C per MIL-PRF-28800F, Class 2
Fungus Resistance	5 species for 28 days at 30°C and 95% humidity per MIL-PRF-28800F, Class 2
Explosive Atmosphere	Per MIL-PRF-28800F 4.5.6.3
Available Upgrades	From any other model to SH-362S

## General Measurement Features

General Applications	<p>Cellular, PCS, DCS, 2G, 3G, 4G, CDMA, cdmaOne, CDMA 2000, 1x, 1x EV-DO, GSM, GPRS, EDGE, UMTS, HSDPA, W-CDMA, TDMA, AMPS, 802.11, Bluetooth, Broadcast, Emergency, Fire, GPS, HDTV, IBOC, In-Building, Lab, LMR, Microwave, NPSPAC, Paging, Police, Private, Project 25, Public Safety, Tactical Military, Telematics, Tetra, Trunking, Utilities, WiMAX, WLAN, and WLL.</p>
----------------------	---

<b>General Measurement Features</b>	
Power Measurement	Supports optional Bird external power sensor models 5012B, 5010B, 5011, 5011-EF, 5010T and 5010. Connect sensors via RS-232 port.
Markers	6 Markers; Modes: On/Off, Standard, Marker to Max Peak, Marker to Next Peak, Center Freq to Marker, Ref Level Ampt to Marker, Marker Delta, Marker Display, Marker Type Line/Icon, Marker Noise, Frequency Counter, All Marker to Peaks, All Markers Off. Also, Marker to Max/Min Peak via Up/Down Arrow Keys, Marker Left/Right via Left/Right Arrow Keys and Wheel.
Averaging	Running display average, 2 to 1024 sweeps
Internal Memory	Store 300 traces and setups
USB Drive	May store over 90,000 traces and setups on a USB drive standard accessory. The contents of the internal memory can be copied to and from a removable USB drive. <b>Note:</b> <i>USB drive must be Windows CE compatible.</i>
Windows CE	Includes Microsoft WordPad (full read and write) and the following viewers (read only): Word, Excel, Power Point, PDF, and Image. Also, Media Player, Internet Explorer, and Messenger. Use of USB mouse and hub recommended (see optional accessories).
User Interface	Reference the user manual and design specification (SH UI document) for further details.
One-Button Setup	Press the setup button and select configuration from the setup list. Setups may be saved to the list.
Help Functions	Help menu displays on-board measurement start-up instructions. Custom Help file may be updated by the user with customized test procedures and notes for on-board display. Tip line provides helpful hints with each key stroke. Clear pocket on inside cover for start-up instruction card and test procedures. Operations manual provides additional information.

<b>PC Tool Software</b>	
General Features	Transfer saved traces to and from Signal Hawk and PC via USB cable or removable USB drive. Graphically display traces on the PC for further analysis. Generate printed reports with customized labels. Archive saved traces to disk or USB drive.
Communication Method	USB port
USB Drive	May store over 90,000 traces and setups on USB drive standard accessory. <b>Note:</b> <i>USB drive must be Windows CE compatible.</i>



## Power Sensors Supported

Sensor	Description
5010B	<p><b>Frequency Range</b> Element dependent, 2 MHz to 2.7 GHz  <b>Power Range</b> Element dependent, 125 mW to 1 kW full scale  <b>Measurements performed:</b> True Average Power, Peak Forward Power (element dependent).  <b>Calculations Performed:</b> VSWR, Return Loss, Reflection Coefficient  <b>Accuracy</b> True Average Power, <math>\pm 5\%</math> of reading (15 °C to 35°C), <math>\pm 7\%</math> of reading (-10 °C to 50°C), Peak Power, <math>\pm 8\%</math> of full scale            Requires two Bird elements</p>
5010T	<p><b>Frequency Range</b> Element dependent, 2 MHz to 2.7 GHz  <b>Power Range</b> Element dependent, 125 mW to 1 kW full scale  <b>Measurements performed:</b> True Average Power, Peak Forward Power (element dependent).  <b>Calculations Performed:</b> VSWR, Return Loss, Reflection Coefficient  <b>Accuracy</b> True Average Power, <math>\pm 5\%</math> of reading (15 °C to 35°C), <math>\pm 7\%</math> of reading (-10 °C to 50°C)</p>
5011	<p><b>Frequency Range</b> 40 MHz - 4.0 GHz  <b>Power Range</b> -20.000 to +10.000 dBm (10.0010 <math>\mu</math>W to 10.000 mW)  <b>Measurements performed:</b> True average power.  <b>Accuracy</b> <math>\pm 5\%</math> of Reading. When operating below 100 MHz and above 40 °C, add 1%.</p>
5011-EF	<p><b>Frequency Range</b> 40 MHz - 12 GHz  <b>Power Range</b> -20.000 to +10.000 dBm (10.0010 <math>\mu</math>W to 10.000 mW)  <b>Measurements performed:</b> True average power.  <b>Accuracy</b> <math>\pm 5\%</math> of Reading. When operating below 100 MHz and above 40 °C, add 1%</p>
5012B	<p><b>Frequency Range</b> 350 MHz - 4.0 GHz  <b>Power Range</b> 150 mW - 150 Watts Avg. 400 Watts Peak  <b>Measurements performed:</b> Peak power, true average power and Duty Cycle.  <b>Calculations Performed:</b> VSWR, Return Loss, Reflection Coefficient, Crest Factor, Average Burst Power and CCDF.  <b>Duty Cycle (D)</b> .001 to 1.0  <b>Accuracy</b> Average Power = <math>\pm 4\%</math> of reading, + 0.05 Watts            Burst Average Power = <math>\pm 6\%</math> of reading, +0.05/D Watts            Peak Envelope Power = <math>\pm 7\%</math> of reading, +0.20 Watts            CCDF = <math>\pm 0.2\%</math> typical</p>

5016B	<p><b>Frequency Range</b> 350 MHz - 4.0 GHz  <b>Power Range</b> 25 mW - 25 Watts Avg. 60 Watts Peak  <b>Measurements performed:</b> Peak power, true average power and Duty Cycle.  <b>Calculations Performed:</b> VSWR, Return Loss, Reflection Coefficient, Crest Factor, Average Burst Power and CCDF.  <b>Duty Cycle (D)</b> .001 to 1.0  <b>Accuracy</b> Average Power = <math>\pm 4\%</math> of reading, + 0.008 Watts  Burst Average Power = <math>\pm 6\%</math> of reading, +0.008/D Watts  Peak Envelope Power = <math>\pm 7\%</math> of reading, +0.05 Watts  CCDF = <math>\pm 0.2\%</math> typical</p>
5017B	<p><b>Frequency Range</b> 25 MHz - 1.0 GHz  <b>Power Range</b> 500 mW - 500 Watts Avg. 1300 Watts Peak  <b>Measurements performed:</b> Peak power, true average power and Duty Cycle.  <b>Calculations Performed:</b> VSWR, Return Loss, Reflection Coefficient, Crest Factor, Average Burst Power and CCDF.  <b>Duty Cycle (D)</b> .001 to 1.0  <b>Accuracy</b> Average Power = <math>\pm 4\%</math> of reading, + 0.17 Watts  Burst Average Power = <math>\pm 6\%</math> of reading, +0.17/D Watts  Peak Envelope Power = <math>\pm 7\%</math> of reading, +0.70 Watts  CCDF = <math>\pm 0.2\%</math> typical</p>
5018B	<p><b>Frequency Range</b> 150 MHz - 4.0 GHz  <b>Power Range</b> 100 mW - 25 Watts Avg. 60 Watts Peak  <b>Measurements performed:</b> Peak power, true average power and Duty Cycle.  <b>Calculations Performed:</b> VSWR, Return Loss, Reflection Coefficient, Crest Factor, Average Burst Power and CCDF.  <b>Duty Cycle (D)</b> .001 to 1.0  <b>Accuracy</b> Average Power = <math>\pm 4\%</math> of reading, + 0.008 Watts  Burst Average Power = <math>\pm 6\%</math> of reading, +0.008/D Watts  Peak Envelope Power = <math>\pm 7\%</math> of reading, +0.05 Watts  CCDF = <math>\pm 0.2\%</math> typical</p>
5019B	<p><b>Frequency Range</b> 25 MHz -1.0 GHz  <b>Power Range</b> 100 mW - 100 Watts Avg. 260 Watts Peak  <b>Measurements performed:</b> Peak power, true average power and Duty Cycle.  <b>Calculations Performed:</b> VSWR, Return Loss, Reflection Coefficient, Crest Factor, Average Burst Power and CCDF.  <b>Duty Cycle (D)</b> .001 to 1.0  <b>Accuracy</b> Average Power = <math>\pm 4\%</math> of reading, + 0.04 Watts  Burst Average Power = <math>\pm 6\%</math> of reading, +0.04/D Watts  Peak Envelope Power = <math>\pm 7\%</math> of reading, +0.13 Watts  CCDF = <math>\pm 0.2\%</math> typical</p>

\* - See sensor manual for more details.

## Parts List

Contact Bird Service Center for parts information.

<b>Standard Accessories</b>		
<b>Description</b>	<b>Part No.</b>	<b>Qty</b>
Soft Carry Case	7002A220-1	1
Operations Manual <sup>1</sup>	920-SH36-OPS	1
Start-Up Instructions <sup>1</sup>	920-SH36-REF	1
USB Cable, 10 ft, USB 2.0 certified, USB A male to USB B male	5A2653-10	1
AC Adapter/Charger, input 100-240 Vac @ 50-60Hz, output +15V, 5A	5A2743-1	1
AC Line Cord for AC Adapter/Charger	4421-055	1
Car Adapter/Charger, input 12VDC, output +12VDC, 5 A	5A2238-3	1
Internal Lithium-Ion Battery. Rechargeable, field replaceable, 8.8 A-hr capacity, 5.5 hours continuous operation.	5A2720-2	1
PC Tool Software and Manuals CD <sup>1</sup>	7002A210	1
USB Drive, Win CE compatible	5A2745-1	1
Connector Cover	7002A221	1

<sup>1</sup> Spare standard accessories are available as optional accessories. Manuals, software, and firmware updates are available at: [www.bird-technologies.com](http://www.bird-technologies.com).

## Optional Accessories

### General

Description	Part No.	Qty
Hard Transit Case, Watertight, Crushproof, and Dust proof	7002A225-1	1
Connector Cover	7002A221	1
USB Mouse, Ultra-Portable, Optical, Retractable Cable	USB-MOUSE	1
USB Hub, 4-Port, Micro	USB-HUB	1

### Spectrum Analyzer

Description	Part No.	Qty
Field Strength Antenna, 136 to 221 MHz, Field Tunable, 0 dB Gain, SMA(M)	ANT-100	1
Field Strength Antenna, 400 to 512 MHz, Field Tunable, 0 dB Gain, SMA(M)	ANT-400	1
Field Strength Antenna, 824 to 894 MHz, 0 dB Gain, Articulating, SMA(M)	ANT-800	1
Field Strength Antenna, 890 to 960 MHz, 0 dB Gain, Articulating, SMA(M)	ANT-900	1
Field Strength Antenna, 1710 to 1880 MHz, 0 dB Gain, Articulating, SMA(M)	ANT-1800	1
Field Strength Antenna, 1850 to 1990 MHz, 0 dB Gain, Articulating, SMA(M)	ANT-1900	1
Field Strength Antenna, 2400 to 2500 MHz, 0 dB Gain, Articulating, SMA(M)	ANT-2400	1
Field Strength Antenna Adapter, N(M), SMA(F)*	4240-500-10	1
Attenuator, 100 W, 40 dB, N(M)/N(F), 2.4 GHz	100-SA-MFN-40	1
Attenuator, 50 W, 30 dB, N(M)/N(F), 4 GHz	50-A-MFN-30	1
Attenuator, 25 W, 30 dB, N(M)/N(F), 4 GHz	25-A-MFN-30	1
Attenuator, 10 W, 30 dB, N(M)/N(F), 4 GHz	10-A-MFN-30	1
Attenuator, 5 W, 20 dB, N(M)/N(F), 4 GHz	5-A-MFN-20	1
Attenuator, 2 W, 20 dB, N(M)/N(F), 4 GHz	2-A-MFN-20	1
Compact GPS Sensor	7002A222-1	1

\* - Recommended for field strength antennas.

### VNA

Description	Part No.	Qty
Calibration Combo, Open/Short/Load, N (M)	CAL-MN-C	1
Calibration Combo, Open/Short/Load, N (F)	CAL-FN-C	1
Calibration Combo, Open/Short/Load, 7/16 DIN (M)	CAL-ME-C	1
Calibration Combo, Open/Short/Load, 7/16 DIN (F)	CAL-FE-C	1
Load, 2 W, N(M)	2-T-MN	1
Load, 2 W, N(F)	2-T-FN	1

## External Power Sensors

Description	Part No.	Qty
<p>WIDEBAND POWER SENSOR</p> <p>Frequency Range</p> <p>5012B: 350 MHz - 4.0 GHz</p> <p>5016B: 350 MHz - 4.0 GHz</p> <p>5017B: 25 MHz - 1.0 GHz</p> <p>5018B: 150 MHz - 4.0 GHz</p> <p>5019B: 25 MHz -1.0 GHz</p> <p>Power Range</p> <p>5012B: 150 mW - 150 Watts Avg. 400 Watts Peak</p> <p>5016B: 25 mW - 25 Watts Avg. 60 Watts Peak</p> <p>5017B: 500 mW - 500 Watts Avg. 1300 Watts Peak</p> <p>5018B: 100 mW - 25 Watts Avg. 60 Watts Peak</p> <p>5019B: 100 mW - 100 Watts Avg. 260 Watts Peak</p> <p><b>Measurements performed:</b> Peak power, true average power and Duty Cycle.</p> <p><b>Calculations Performed:</b> VSWR, Return Loss, Reflection Coefficient, Crest Factor, Average Burst Power and CCDF.</p> <p><b>Duty Cycle (D)</b> .001 to 1.0</p> <p>Average Power Accuracy</p> <p>5012B: <math>\pm 4\%</math> of reading, + 0.05 Watts</p> <p>5016B: <math>\pm 4\%</math> of reading, + 0.008 Watts</p> <p>5017B: <math>\pm 4\%</math> of reading, + 0.17 Watts</p> <p>5018B: <math>\pm 4\%</math> of reading, + 0.008 Watts</p> <p>5019B: <math>\pm 4\%</math> of reading, + 0.04 Watts</p> <p>Burst Power Accuracy</p> <p>5012B: <math>\pm 6\%</math> of reading, +0.05/D Watts</p> <p>5016B: <math>\pm 6\%</math> of reading, +0.008/D Watts</p> <p>5017B: <math>\pm 6\%</math> of reading, +0.17/D Watts</p> <p>5018B: <math>\pm 6\%</math> of reading, +0.008/D Watts</p> <p>5019B: <math>\pm 6\%</math> of reading, +0.04/D Watts</p> <p><b>Peak Envelope Power Accuracy</b></p> <p>5012B: <math>\pm 7\%</math> of reading, +0.20 Watts</p> <p>5016B: <math>\pm 7\%</math> of reading, +0.05 Watts</p> <p>5017B: <math>\pm 7\%</math> of reading, +0.70 Watts</p> <p>5018B: <math>\pm 7\%</math> of reading, +0.05 Watts</p> <p>5019B: <math>\pm 7\%</math> of reading, +0.13 Watts</p> <p>CCDF = <math>\pm 0.2\%</math> typical</p>	<p>5012B, 5016B, 5017B, 5018B, &amp; 5019B</p>	<p>1</p>

Description	Part No.	Qty
<p>DIRECTIONAL POWER SENSOR</p> <p><b>Frequency Range</b> Element dependent, 2 MHz to 2.7 GHz</p> <p><b>Power Range</b> Element dependent, 125 mW to 1 kW full scale</p> <p><b>Measurements performed:</b> True Average Power, Peak Forward Power (element dependent).</p> <p>Calculations Performed: VSWR, Return Loss, Reflection Coefficient</p> <p><b>Accuracy</b> True Average Power, <math>\pm 5\%</math> of reading (15 °C to 35°C), <math>\pm 7\%</math> of reading (-10 °C to 50°C), Peak Power, <math>\pm 8\%</math> of full scale</p>	5010B	1
<p>DIRECTIONAL POWER SENSOR, TETRA VERSION</p> <p><b>Frequency Range</b> Element dependent, 2 MHz to 2.7 GHz</p> <p><b>Power Range</b> Element dependent, 125 mW to 1 kW full scale</p> <p><b>Measurements performed:</b> True Average Power, Peak Forward Power (element dependent).</p> <p>Calculations Performed: VSWR, Return Loss, Reflection Coefficient</p> <p><b>Accuracy</b> True Average Power, <math>\pm 5\%</math> of reading (15 °C to 35°C), <math>\pm 7\%</math> of reading (-10 °C to 50°C)</p>	5010T	1
<p>TERMINATING POWER SENSOR</p> <p><b>Frequency Range</b> 40 MHz - 4.0 GHz</p> <p><b>Power Range</b> -20.000 to +10.000 dBm (10.0010 <math>\mu</math>W to 10.000 mW)</p> <p><b>Measurements performed:</b> True average power.</p> <p><b>Accuracy</b> <math>\pm 5\%</math> of Reading. When operating below 100 MHz and above 40 °C, add 1%.</p>	5011	1
<p>TERMINATING POWER SENSOR, EXTENDED FREQUENCY</p> <p><b>Frequency Range</b> 40 MHz - 12 GHz</p> <p><b>Power Range</b> -20.000 to +10.000 dBm (10.0010 <math>\mu</math>W to 10.000 mW)</p> <p><b>Measurements performed:</b> True average power.</p> <p><b>Accuracy</b> <math>\pm 5\%</math> of Reading. When operating below 100 MHz and above 40 °C, add 1%</p>	5011-EF	1

\* - Recommended for field strength antennas.

## Test Cables and Adapters

---

Description	Part No.	Qty
Test Cable, Phase Stable, 1.5 m, N(M) to N(F)	TC-MNFN-1.5	1
Test Cable, Phase Stable, 3.0 m, N(M) to N(F)	TC-MNFN-3.0	1
Test Cable, Phase Stable, 1.5 m, N(M) to N(M)	TC-MNMMN-1.5	1
Test Cable, Phase Stable, 3.0 m, N(M) to N(M)	TC-MNMMN-3.0	1
Test Cable, Phase Stable, 1.5 m, N(M) to 7/16 DIN(F)	TC-MNFE-1.5	1
Test Cable, Phase Stable, 3.0 m, N(M) to 7/16 DIN(F)	TC-MNFE-3.0	1
Test Cable, Phase Stable, 1.5 m, N(M) to 7/16 DIN(M)	TC-MNME-1.5	1
Test Cable, Phase Stable, 3.0 m, N(M) to 7/16 DIN(M)	TC-MNME-3.0	1
Adapter, N(M) to 7/16 DIN(M)	PA-MNME	1
Adapter, N(F) to 7/16 DIN(M)	PA-FNME	1
Adapter, N(M) to 7/16 DIN(F)	PA-MNFE	1
Adapter, N(F) to 7/16 DIN(F)	PA-FNFE	1
Adapter Kit, 7/16 DIN	4240-550	
Adapter, N(F) to N(F)	4240-500-1	
Adapter, N(M) to N(M)	4240-500-6	1
Adapter, N(M) to SMA(F)*	4240-500-10	
Interseries Adapter Kit, N/SMA/BNC/TNC/UHF	4240-401	

\* - Recommend N(M) to SMA(F) adapter for field strength antennas.

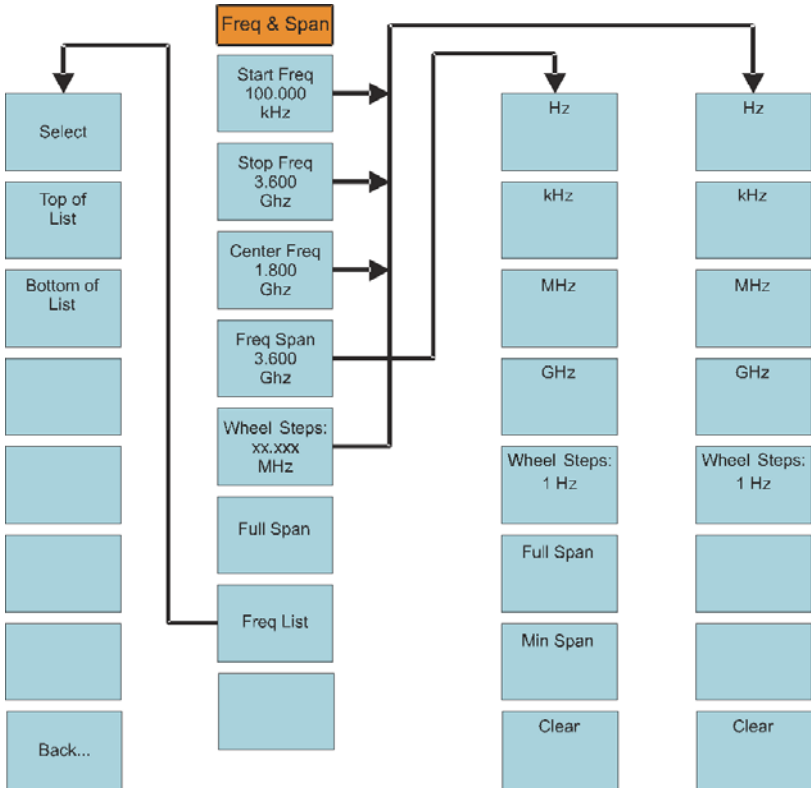
# ROHS

Part Name	Toxic or hazardous Substances and Elements					
	Lead (Pb)	Mercury (Hg)	Cadmium (Cd)	Hexavalent Chromium (Cr(VI))	Polybrominated biphenyls (PBB)	Polybrominated diphenyl ethers (PBDE)
<b>Copper Alloy</b>	X	O	O	O	O	O
<b>Florescent Backlight</b>	O	X	O	O	O	O
<b>Printed Circuit Assembly</b>	X	O	O	O	O	O
<p><b>O:</b> Indicates that this toxic or hazardous substance contained in all of the homogeneous materials for this part is below the limit requirement in SJ/T11363-2006.</p> <p><b>X:</b> Indicates that this toxic or hazardous substance contained in at least one of the homogeneous materials used for this part is above the limit requirements in SJ/T11363-2006.</p>						

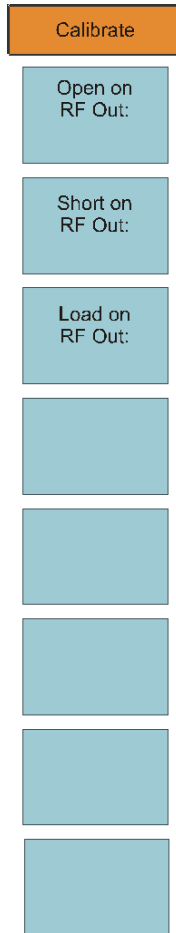


# Vector Network Analyzer (VNA) Menu Maps

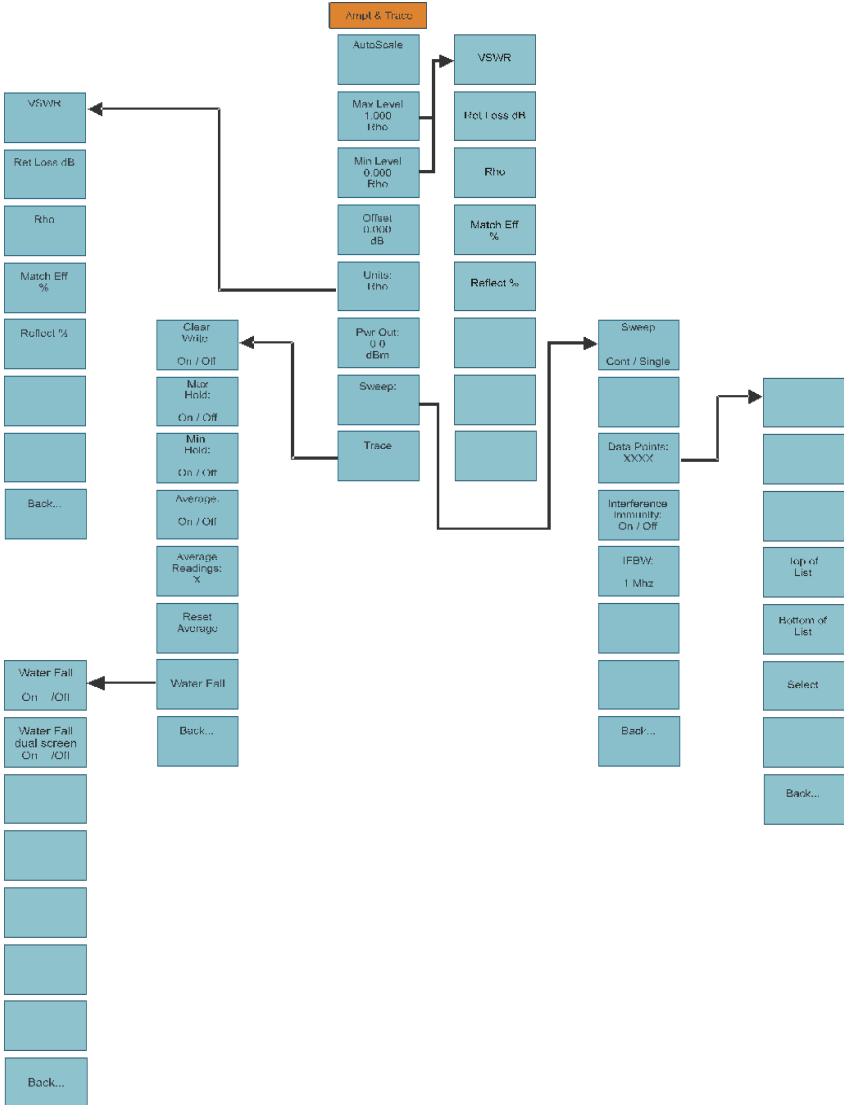
Figure 116 Map, Freq & Span, All Measurements



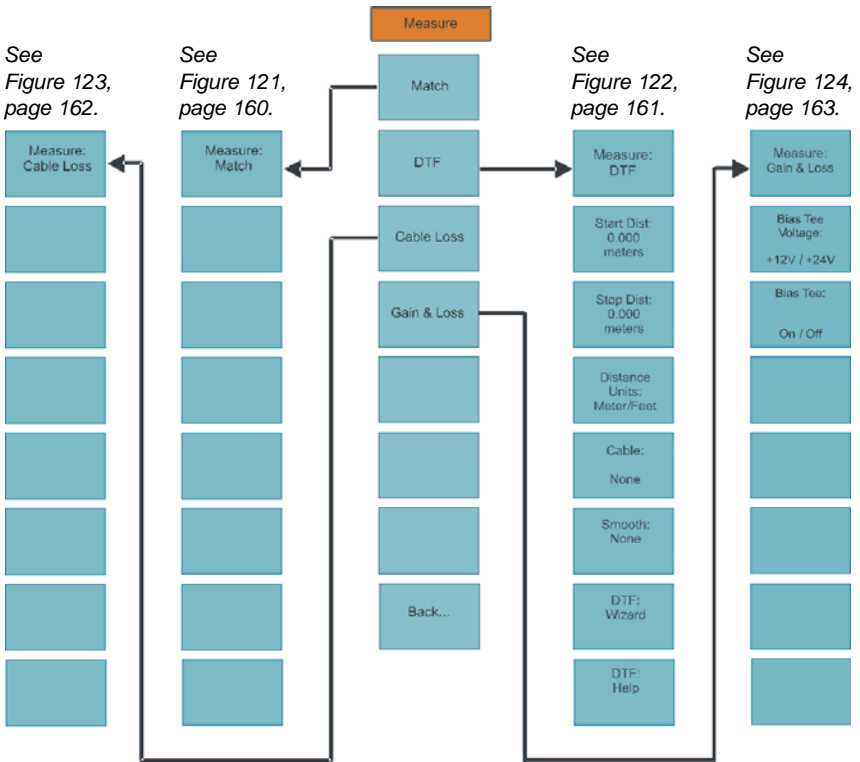
**Figure 117** *Map, Calibrate, All Measurements*



**Figure 118 Map, Ampt & Trace, All Measurements**

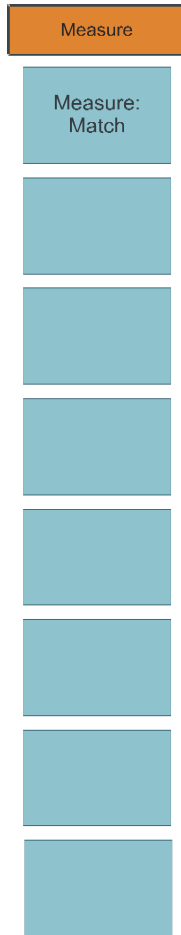


**Figure 119 Map, Measurement**

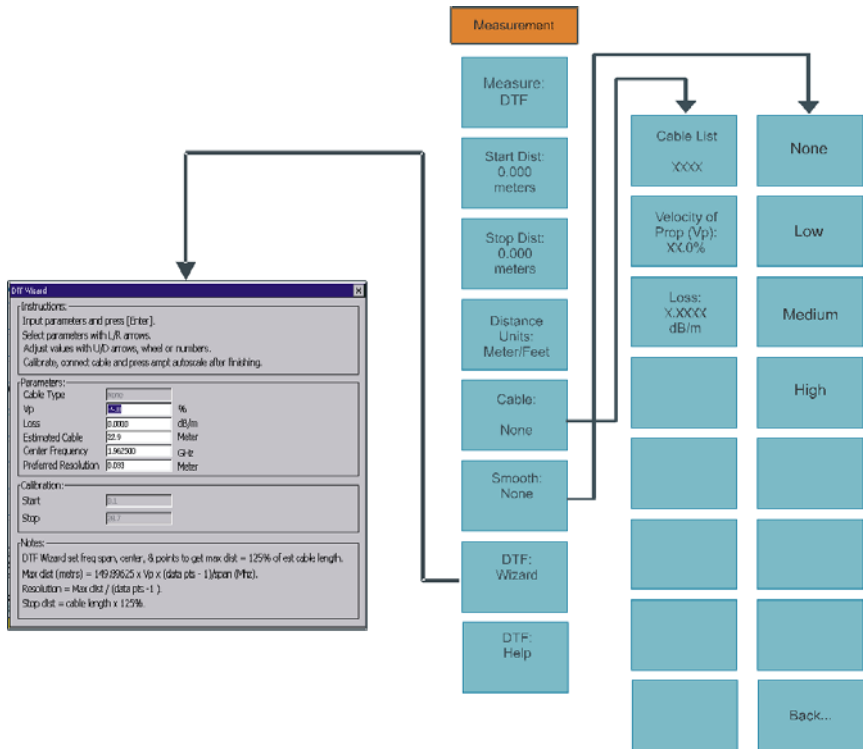




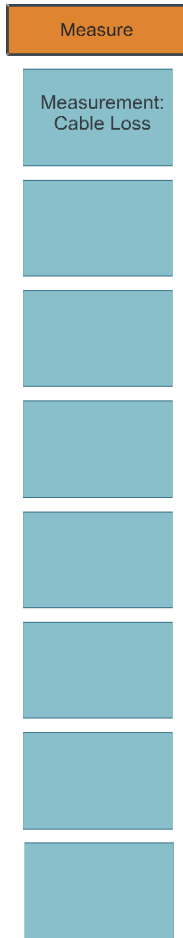
**Figure 121** *Map, Measurement, Match Measure*



**Figure 122 Map, Measurement, Distance-to-Fault Measure**

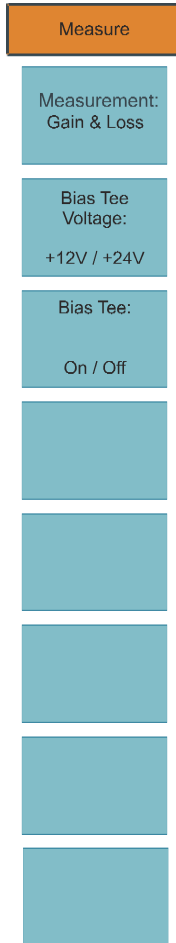


**Figure 123** *Map, Measurement, Cable Loss Measure*





**Figure 124** *Map, Measurement, Gain & Loss Measure*

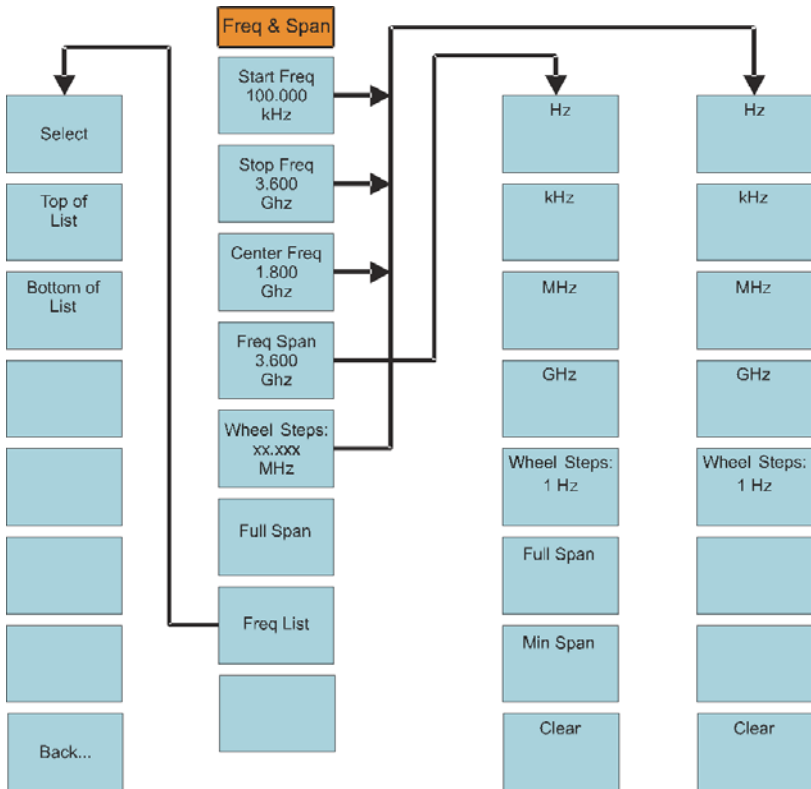


# Spectrum Analyzer Menu Maps

The illustrations in this section show the soft key options that are available when you select a measurement function.

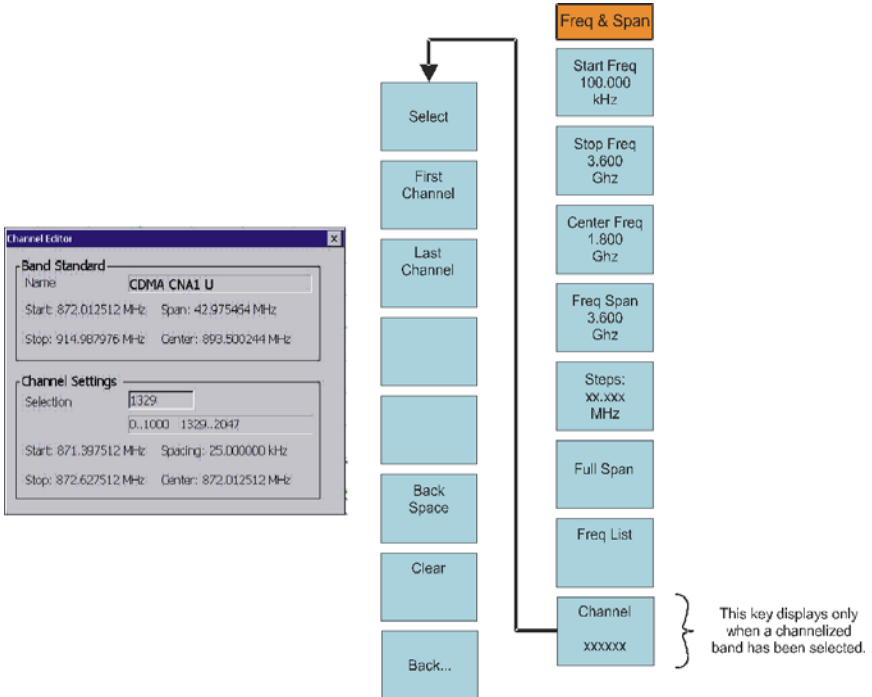
**Figure 125** Menu Map, Freq & Span Menu, All Measurements

**Note:** If a channelized band is selected, there will be an extra soft key named Channel (see Fig. 126).

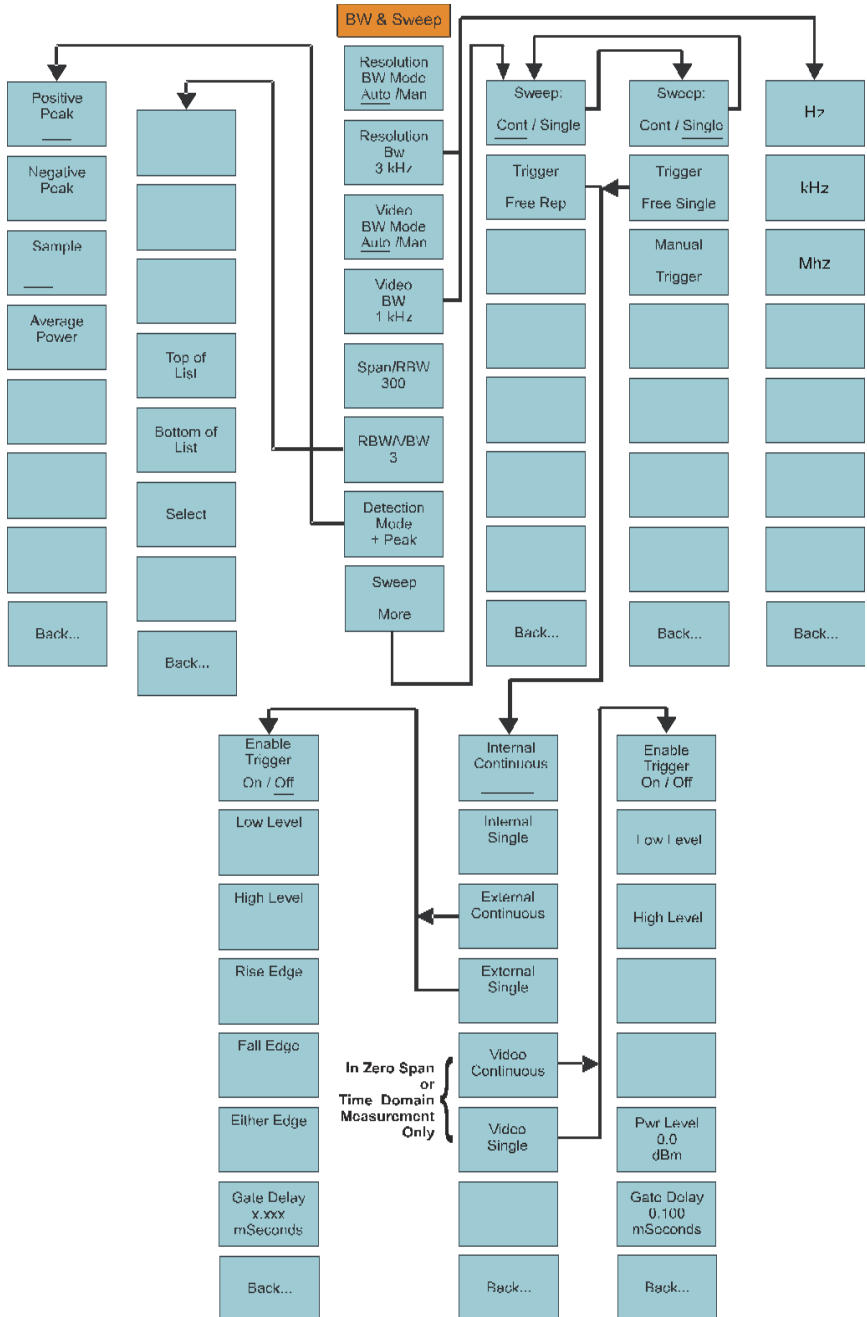


**Figure 126 Menu Map, Freq/Span Menu, Channelized Band**

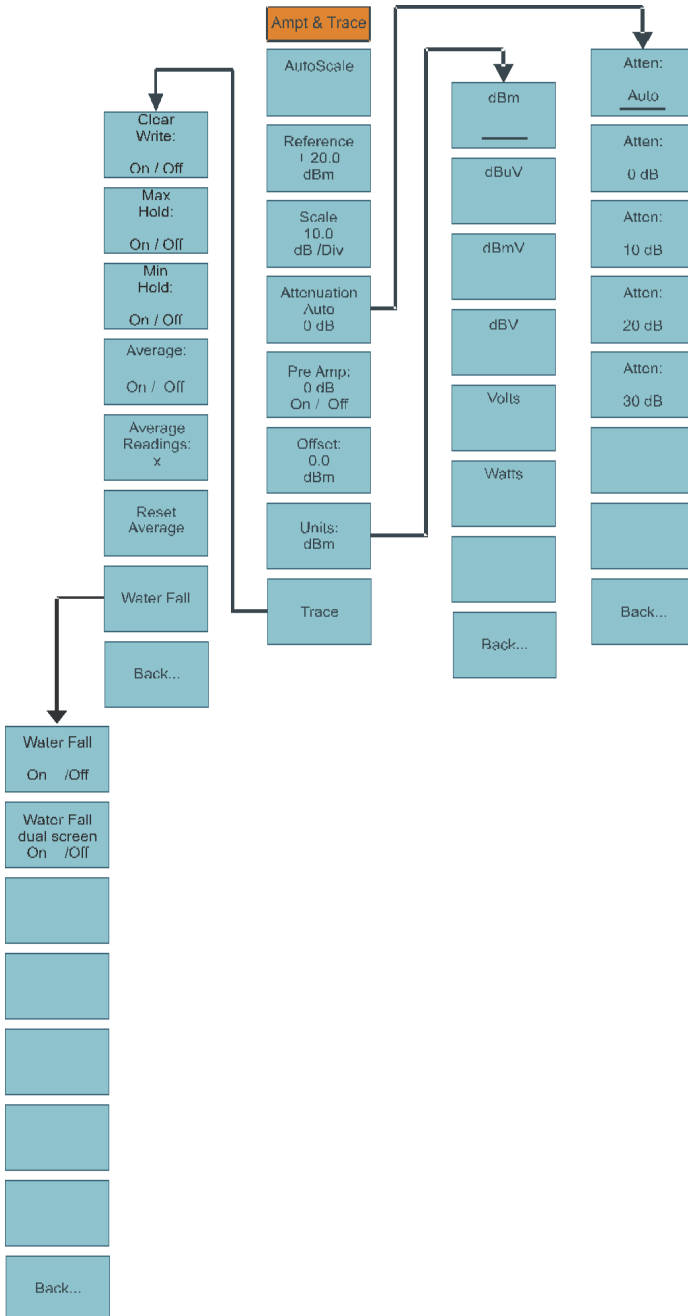
**Note:** If a channelized band is selected, the system displays the Channel soft key in addition to those shown in Fig. 125.



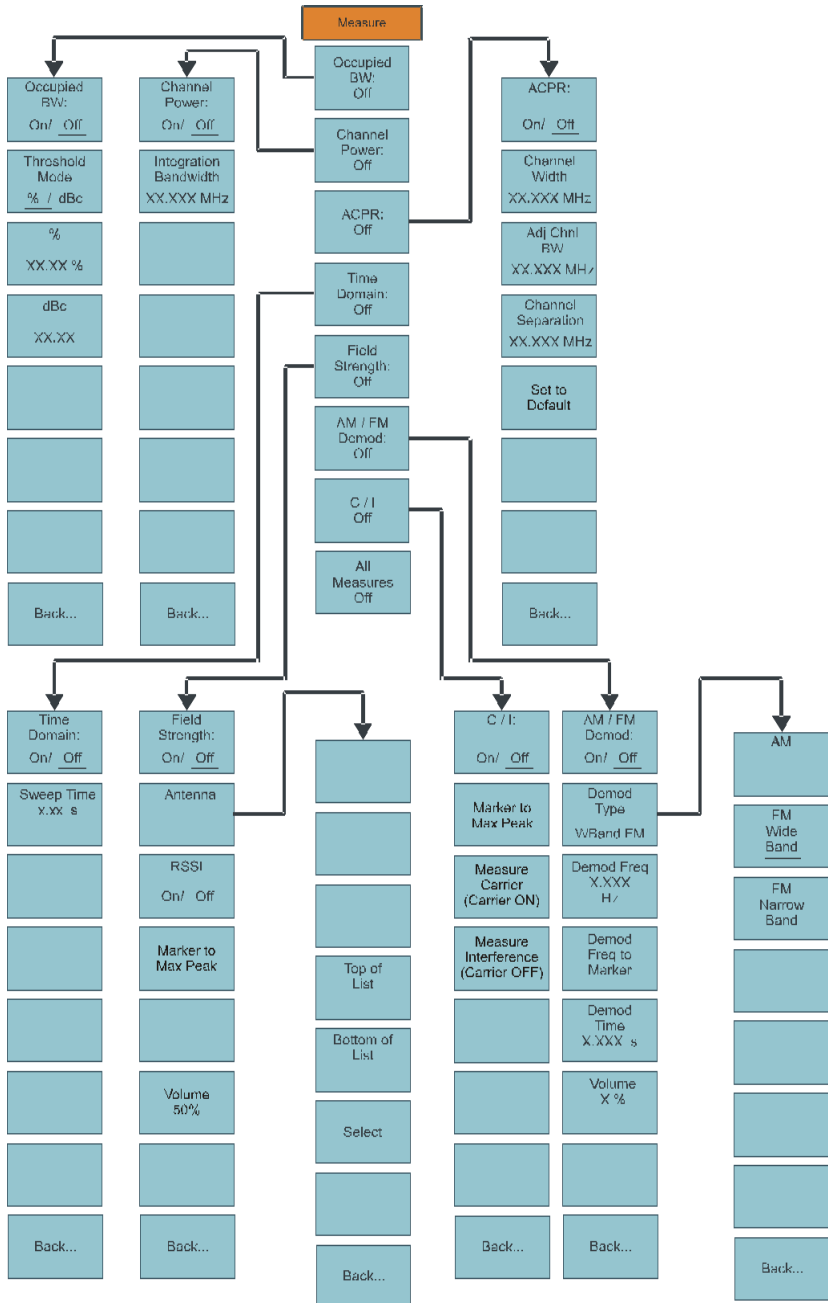
**Figure 127 Menu Map, BW & Sweep Menu, All Measurements**



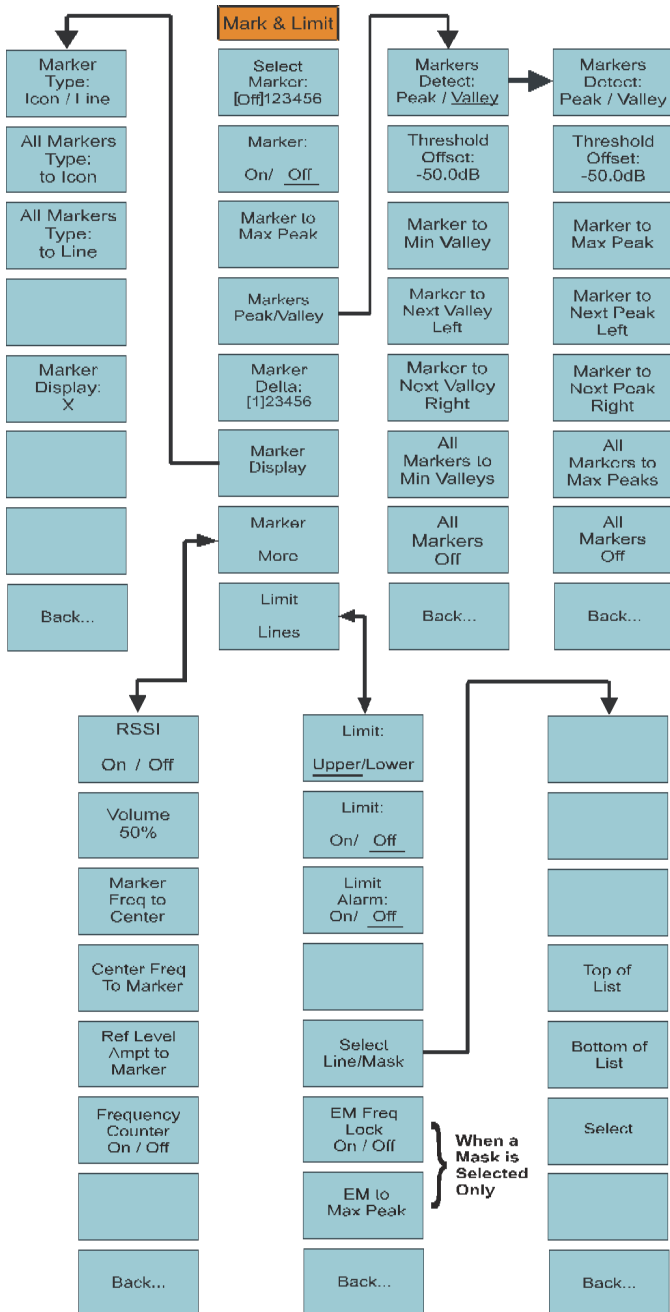
**Figure 128 Menu Map, Ampt & Trace, All Measurements**



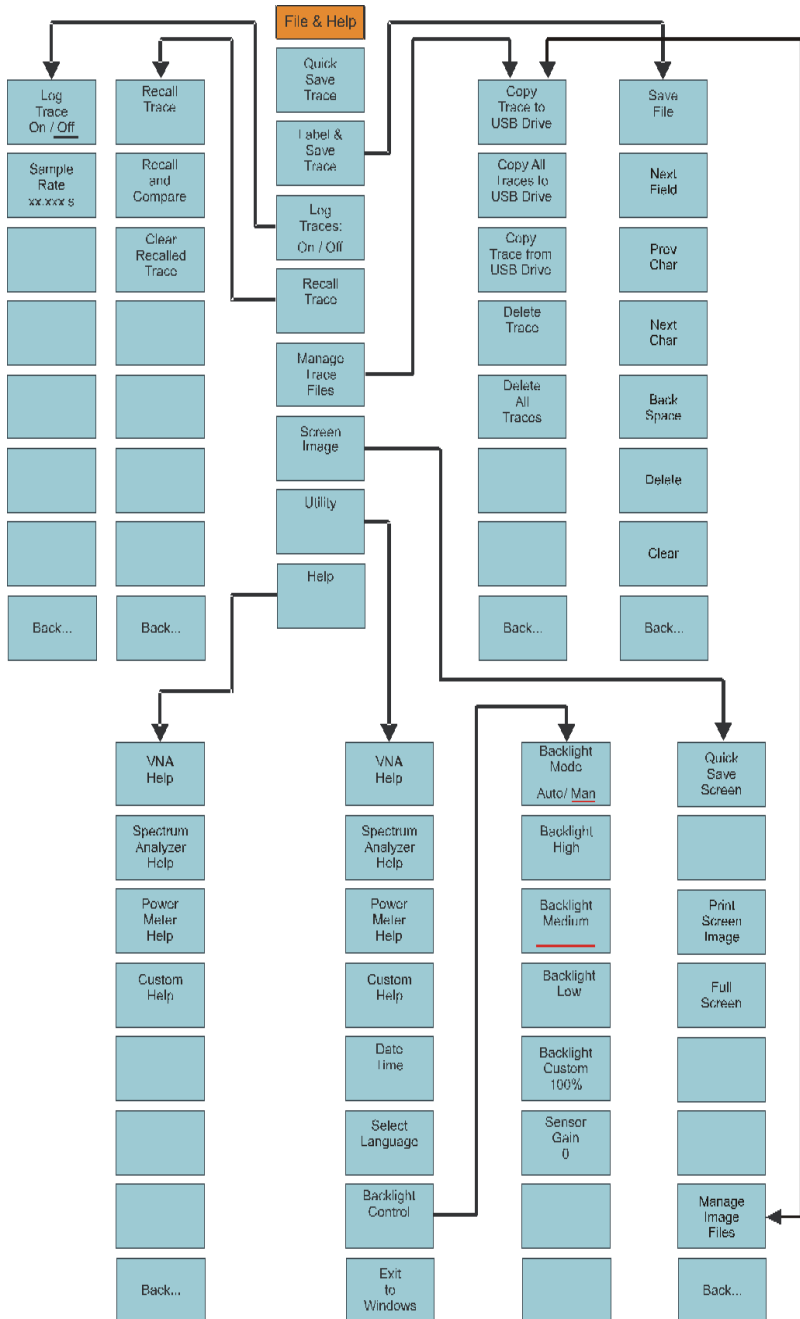
**Figure 129 Menu Map, Measurement, All Measurements**



**Figure 130 Menu Map, Mark & Limit Menu, All Measurements**



**Figure 131 Menu Map, File & Help, All Measurements**

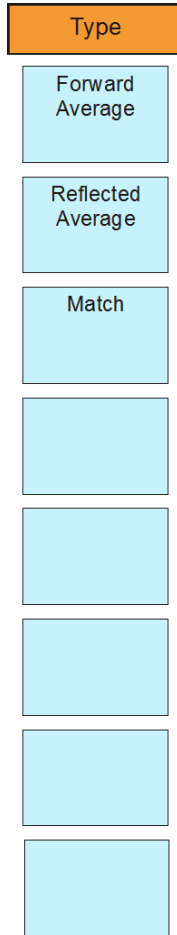




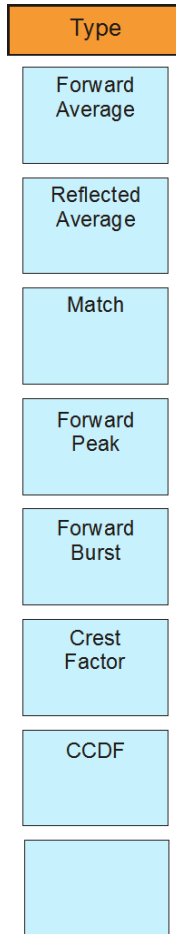
# Power Meter Menu Maps

---

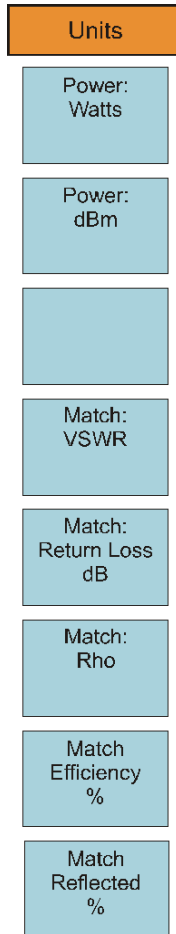
*Figure 132 Menu Map, Power Meter, Directional Type*



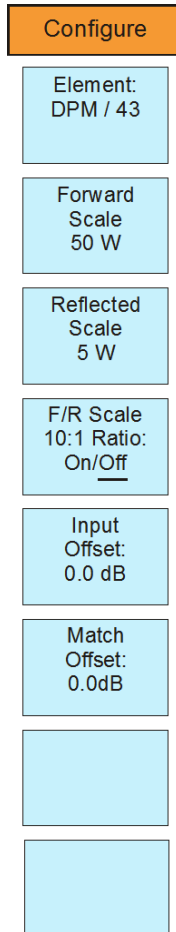
**Figure 133** *Menu Map, Power Meter, Wideband*



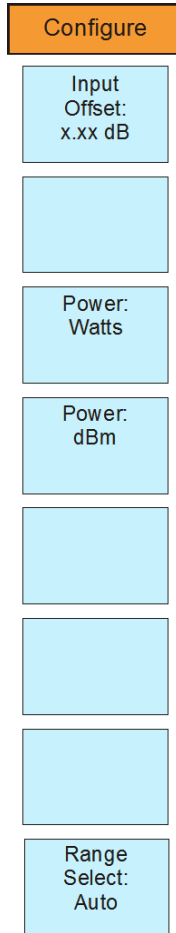
**Figure 134** *Map, Power Meter, Units, Directional and Wideband Type*



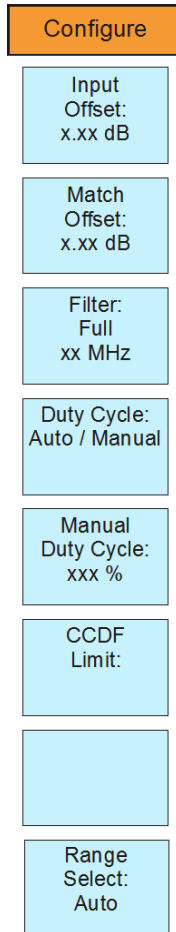
**Figure 135** *Map, Power Meter, Configure, Directional Type*



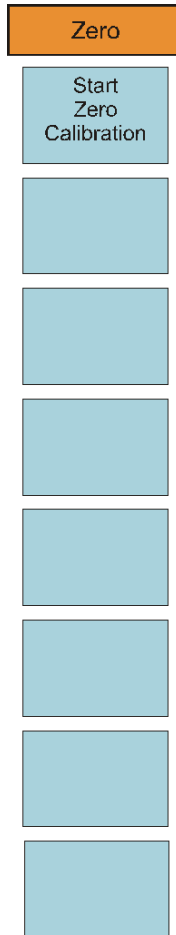
**Figure 136** *Map, Power Meter, Configure, Terminating Type*



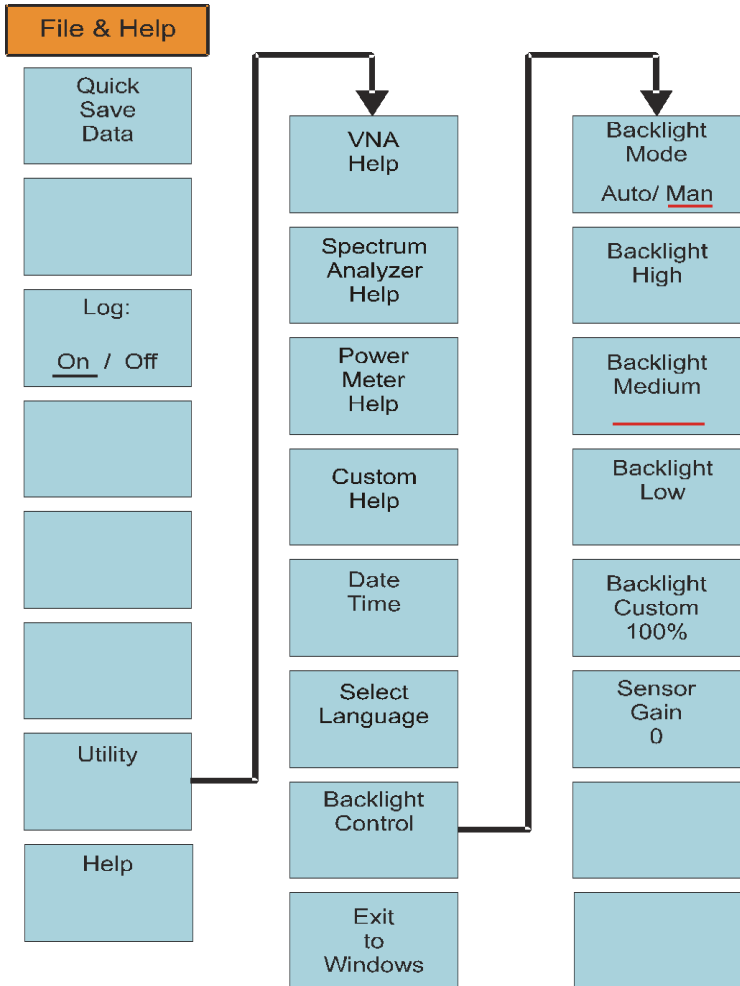
**Figure 137** *Map, Power Meter, Configure, Wideband Type*



**Figure 138** *Map, Power Meter, Zero, Terminating and Wideband Type*



**Figure 139** Map, Power Meter, File & Help, All Sensors

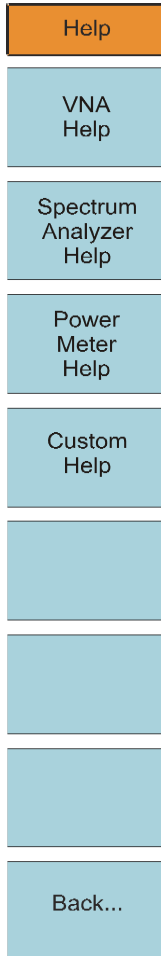




# Start Menu, Help Menu Maps

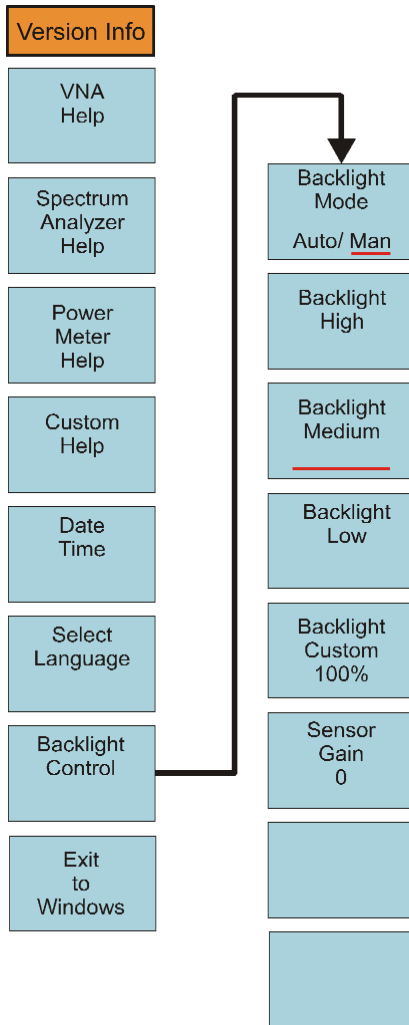
---

Figure 140 Map, Start Menu, Help



# Start Menu, Utilities Menu Map


Figure 141 Map, Utilities, Version Info



## Figure 142 Map, Utilities, GPS Info

Utility Menu

10:07:58 AM 22-Mar-2010

Bird Technologies Group 30303 Aurora Road Solon, Ohio 44139-2794 USA		Phone: 866-695-4569 www.bird-technologies.com	
Latitude: 0° 0' 0.00" Longitude: 0° 0' 0.00" Altitude: 0.0 m Name: UTC: 00:00:00.00 Fix: No Fix		 PRN: <input type="text"/> <input type="text"/> <input type="text"/> <input type="text"/> <input type="text"/> <input type="text"/> <input type="text"/> <input type="text"/> <input type="text"/> <input type="text"/> <input type="text"/> Satellite(s) SNR (0 to 99 dB)	
Version Info		GPS Info	

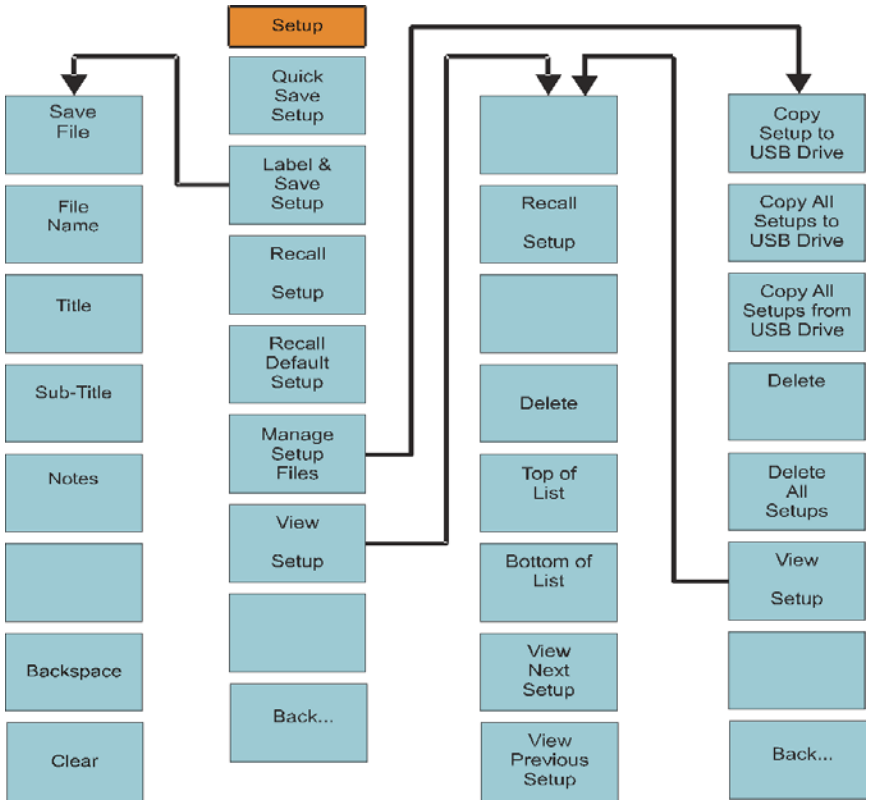
Altitude Unit  
m /ft

Lat/Lon Format  
dm/ dms

Navigation menu buttons: [Map] [Utilities] [GPS Info] [Settings] [Help] [Exit]

# Setup Function Menu Maps

Figure 143 Map, Setup, Main Screen



---

## LIMITED WARRANTY

All products manufactured by Seller are warranted to be free from defects in material and workmanship for a period of one year, unless otherwise specified, from date of shipment and to conform to applicable specifications, drawings, blueprints and/or samples. Seller's sole obligation under these warranties shall be to issue credit, repair or replace any item or part thereof which is proved to be other than as warranted; no allowance shall be made for any labor charges of Buyer for replacement of parts, adjustment or repairs, or any other work, unless such charges are authorized in advance by Seller.

If Seller's products are claimed to be defective in material or workmanship or not to conform to specifications, drawings, blueprints and/or samples, Seller shall, upon prompt notice thereof, either examine the products where they are located or issue shipping instructions for return to Seller (transportation-charges prepaid by Buyer). In the event any of our products are proved to be other than as warranted, transportation costs (cheapest way) to and from Seller's plant, will be borne by Seller and reimbursement or credit will be made for amounts so expended by Buyer. Every such claim for breach of these warranties shall be deemed to be waived by Buyer unless made in writing within ten days from the date of discovery of the defect.

The above warranties shall not extend to any products or parts thereof which have been subjected to any misuse or neglect, damaged by accident, rendered defective by reason of improper installation or by the performance of repairs or alterations outside of our plant, and shall not apply to any goods or parts thereof furnished by Buyer or acquired from others at Buyer's request and/or to Buyer's specifications. Routine (regularly required) calibration is not covered under this limited warranty. In addition, Seller's warranties do not extend to the failure of tubes, transistors, fuses and batteries, or to other equipment and parts manufactured by others except to the extent of the original manufacturer's warranty to Seller.

The obligations under the foregoing warranties are limited to the precise terms thereof. These warranties provide exclusive remedies, expressly in lieu of all other remedies including claims for special or consequential damages. SELLER NEITHER MAKES NOR ASSUMES ANY OTHER WARRANTY WHATSOEVER, WHETHER EXPRESS, STATUTORY, OR IMPLIED, INCLUDING WARRANTIES OF MERCHANTABILITY AND FITNESS, AND NO PERSON IS AUTHORIZED TO ASSUME FOR SELLER ANY OBLIGATION OR LIABILITY NOT STRICTLY IN ACCORDANCE WITH THE FOREGOING.

