



SIGNALHAWK  
SPECTRUM ANALYZER

MODEL SH-42S

OPERATION MANUAL

## Safety Precautions

---

The following are general safety precautions that are not necessarily related to any specific part or procedure, and do not necessarily appear elsewhere in this publication. These precautions must be thoroughly understood and apply to all phases of operation and maintenance.

### **WARNING**

#### **Keep Away From Live Circuits**

Operating Personnel must at all times observe general safety precautions. Do not replace components or make adjustments to the inside of the test equipment with the high voltage supply turned on. To avoid casualties, always remove power.

### **WARNING**

#### **Shock Hazard**

Do not attempt to remove the RF transmission line while RF power is present.

### **WARNING**

#### **Do Not Service Or Adjust Alone**

Under no circumstances should any person reach into an enclosure for the purpose of service or adjustment of equipment except in the presence of someone who is capable of rendering aid.

### **WARNING**

#### **Safety Earth Ground**

An uninterruptible earth safety ground must be supplied from the main power source to test instruments. Grounding one conductor of a two conductor power cable is not sufficient protection. Serious injury or death can occur if this grounding is not properly supplied.

### **WARNING**

#### **Resuscitation**

Personnel working with or near high voltages should be familiar with modern methods of resuscitation.

### **WARNING**

#### **Remove Power**

Observe general safety precautions. Do not open the instrument with the power applied.

## Safety Symbols

### WARNING

Warning notes call attention to a procedure, which if not correctly performed, could result in personal injury.

### CAUTION

Caution notes call attention to a procedure, which if not correctly performed, could result in damage to the instrument.



The caution symbol appears on the equipment indicating there is important information in the instruction manual regarding that particular area

**Note:** *Calls attention to supplemental information.*

## Warning Statements

The following safety warnings appear in the text where there is danger to operating and maintenance personnel, and are repeated here for emphasis.

### WARNING

Leaking RF energy is a potential health hazard. Never attempt to connect or disconnect equipment from the transmission line while RF power is being applied. Severe burns, electrical shock, or death can occur.

See page 6.

## Caution Statements

---

The following equipment cautions appear in the text whenever the equipment is in danger of damage, and are repeated here for emphasis.

**CAUTION**

Do not exceed maximum input power levels.  
Exceeding the maximum input will damage the SignalHawk.  
If unsure of power levels, measure the test connection with a power sensor  
before using the SignalHawk.

See page 6.

**CAUTION**

Do not block airflow to fan or air vents.  
Unit will overheat if the fan is not circulating air through the unit.

See page 8.

**CAUTION**

Replace battery pack with OEM part only, do not use any other battery.

See page 34.

## **Safety Statements**

---

### **USAGE**

ANY USE OF THIS INSTRUMENT IN A MANNER NOT SPECIFIED BY THE MANUFACTURER MAY IMPAIR THE INSTRUMENT'S SAFETY PROTECTION.

### **USO**

EL USO DE ESTE INSTRUMENTO DE MANERA NO ESPECIFICADA POR EL FABRICANTE, PUEDE ANULAR LA PROTECCIÓN DE SEGURIDAD DEL INSTRUMENTO.

### **BENUTZUNG**

WIRD DAS GERÄT AUF ANDERE WEISE VERWENDET ALS VOM HERSTELLER BESCHRIEBEN, KANN DIE GERÄTESICHERHEIT BEEINTRÄCHTIGT WERDEN.

### **UTILISATION**

TOUTE UTILISATION DE CET INSTRUMENT QUI N'EST PAS EXPLICITEMENT PRÉVUE PAR LE FABRICANT PEUT ENDOMMAGER LE DISPOSITIF DE PROTECTION DE L'INSTRUMENT.

### **IMPIEGO**

QUALORA QUESTO STRUMENTO VENISSE UTILIZZATO IN MODO DIVERSO DA COME SPECIFICATO DAL PRODUTTORE LA PROZIONE DI SICUREZZA POTREBBE VENIRNE COMPROMESSA.

## **SERVICE**

SERVICING INSTRUCTIONS ARE FOR USE BY SERVICE - TRAINED PERSONNEL ONLY. TO AVOID DANGEROUS ELECTRIC SHOCK, DO NOT PERFORM ANY SERVICING UNLESS QUALIFIED TO DO SO.

## **SERVICIO**

LAS INSTRUCCIONES DE SERVICIO SON PARA USO EXCLUSIVO DEL PERSONAL DE SERVICIO CAPACITADO. PARA EVITAR EL PELIGRO DE DESCARGAS ELÉCTRICAS, NO REALICE NINGÚN SERVICIO A MENOS QUE ESTÉ CAPACITADO PARA HACERLO.

## **WARTUNG**

ANWEISUNGEN FÜR DIE WARTUNG DES GERÄTES GELTEN NUR FÜR GESCHULTES FACHPERSONAL. ZUR VERMEIDUNG GEFÄHRLICHE, ELEKTRISCHE SCHOCKS, SIND WARTUNGSARBEITEN AUSSCHLIEßLICH VON QUALIFIZIERTEM SERVICEPERSONAL DURCHZUFÜHREN.

## **ENTRETIEN**

L'EMPLOI DES INSTRUCTIONS D'ENTRETIEN DOIT ÊTRE RÉSERVÉ AU PERSONNEL FORMÉ AUX OPÉRATIONS D'ENTRETIEN. POUR PRÉVENIR UN CHOC ÉLECTRIQUE DANGEREUX, NE PAS EFFECTUER D'ENTRETIEN SI L'ON N'A PAS ÉTÉ QUALIFIÉ POUR CE FAIRE.

## **ASSISTENZA TECNICA**

LE ISTRUZIONI RELATIVE ALL'ASSISTENZA SONO PREVISTE ESCLUSIVAMENTE PER IL PERSONALE OPPORTUNAMENTE ADDESTRATO. PER EVITARE PERICOLOSE SCOSSE ELETTRICHE NON EFFETTUARRE ALCUNA RIPARAZIONE A MENO CHE QUALIFICATI A FARLA.

## About This Manual

---

This manual covers the operating and maintenance instructions for the following models:

SH-42S

## Changes to this Manual

---

We have made every effort to ensure this manual is accurate. If you discover any errors, or if you have suggestions for improving this manual, please send your comments to our Solon, Ohio factory. This manual may be periodically updated. When inquiring about updates to this manual refer to the part number and revision on the title page.

## Chapter Layout

---

**Introduction** — Describes the functions and features of the SH-42S. There is a description of the units controls and a list of items supplied with the unit.

**Setup** — Describes the power requirements, provides example test setup connections, as well as power on, viewing a signal, and power off.

**User Interface** — Describes the touch screen user interface and provides instructions on various data entry and control features. A description of system settings such as startup state, custom configurations and language support are also covered.

**Operation** — This section provides details about important spectrum analyzer settings frequently used to assist in identifying signals of interest.

**Measurements** — The SH-42S includes a number of preprogrammed measurement functions designed to aid in system optimization.

**Maintenance** — Lists routine maintenance tasks as well as battery replacement and file system operations.

**Specifications** — Provides the device characteristics and signal analysis specifications.

# TABLE OF CONTENTS

<b>Safety Precautions</b> .....	<b>i</b>
Safety Symbols .....	ii
Warning Statements .....	ii
Caution Statements .....	iii
Safety Statements .....	iv
<b>About This Manual</b> .....	<b>vi</b>
Changes to this Manual .....	vi
Chapter Layout .....	vi
<b>Chapter 1 Introduction</b> .....	<b>1</b>
Functions and Features .....	1
Items Supplied .....	2
External Controls, Connectors, and Indicators .....	3
Power Supply .....	4
Internal Battery .....	4
External AC Power Supply .....	4
<b>Chapter 2 Setup</b> .....	<b>5</b>
Unpacking and Inspection .....	5
Preparation for Use .....	5
Power Requirements .....	5
Charge the Battery .....	5
RF Connections .....	6
Maximum Signal Levels .....	6
Test Connection Setup .....	6
Power On .....	8
Viewing a Signal .....	8
Using a USB Device .....	9
Power Off .....	9
Normal Power Off .....	9
Forced Power Off .....	9
<b>Chapter 3 User Interface</b> .....	<b>10</b>
User Interface .....	10
Data Entry/Display Controls .....	15



---

Rotary Dial Adjustments . . . . .	15
Selection List Adjustments . . . . .	16
Direct Data Entry Adjustments . . . . .	17
System Settings . . . . .	18
Startup State . . . . .	18
Custom Configuration . . . . .	20
Screen Captures . . . . .	20
Languages . . . . .	21
<b>Chapter 4 Operation . . . . .</b>	<b>22</b>
Automatic/Coupled Settings . . . . .	22
Resetting coupled settings to auto . . . . .	23
Resolution Bandwidth . . . . .	24
Pre-Amplification for low level signals . . . . .	25
Detector Settings . . . . .	26
<b>Chapter 5 Measurements . . . . .</b>	<b>27</b>
Adjacent Channel Power Measurement . . . . .	27
ACPR Setup . . . . .	28
Channel Power Measurement . . . . .	29
Channel Power Setup . . . . .	29
Occupied Bandwidth Measurement . . . . .	30
Occupied Bandwidth Setup . . . . .	30
N dB Down Measurement . . . . .	31
N dB Down Setup . . . . .	31
Phase Noise Measurement . . . . .	32
Phase Noise Setup . . . . .	32
Power Measurements . . . . .	33
<b>Chapter 6 Maintenance . . . . .</b>	<b>34</b>
Cleaning . . . . .	34
Instrument Calibration . . . . .	34
Troubleshooting . . . . .	34
Repair . . . . .	34
Battery Replacement . . . . .	34
File System . . . . .	36

- Transfer files ..... 36
- Delete Files ..... 40
- Firmware Updates ..... 41
- Customer Service ..... 42
- Chapter 7 Specifications ..... 43**
- Signal Analysis Specifications ..... 43
- Device Characteristics ..... 44
  - Instrument Calibration ..... 44
  - Physical characteristics ..... 44
  - Software Characteristics ..... 44
- Limited Warranty ..... 46**

The SignalHawk model SH-42S is a hand-held, fully functional spectrum analyzer designed for use in the installation and maintenance of Radio Frequency (RF) and wireless systems.

## Functions and Features

---

- Analysis of radio frequency spectrum from 10 MHz to 4.2 GHz. Measures intended and interfering signals. Allows setup of parameters such as frequency, amplitude and markers. Graphically displays signals amplitude vs. frequency and provides the ability to save traces.
- Predefined measurements include Occupied Bandwidth (OBW), Channel Power (CH Power), Adjacent Channel Power Ratio (ACPR), and N dB Down.
- Selectable sensitivity to adjust for varied input power levels.
- Battery powered operation up to six hours.
- Touchscreen interface.
- Precision Power Measurement using Bird Power Sensors and the Bird RF Meter App.

**Figure 1** *SH-42S SignalHawk Spectrum Analyzer*



## Items Supplied

---

<b>Description</b>	<b>Part Number</b>
Hard Carrying Case	SPM-AS007
Soft Carrying Case	SPM-AS008
AC Adapter (12 VDC)	SPM-AS001
AC Power Cable (US Standard)	SPM-AS003
Touch Pen (stylus)	SPM-AS006
USB Cable	SPM-AS004
USB Adapter (USB-C to USB-A)	SPM-AS005
USB Drive	SPM-AS009
Lithium Ion Battery	SPM-021
Instruction Manual	920-SH-42S

## External Controls, Connectors, and Indicators



<i>Item</i>	<i>Description</i>
1	RF input connector, female N-type, 50 Ohms
2	Air vent, a vent is located on each side of the unit
3	Power Switch
4	Fan and air exhaust port
5	USB-C connector <b>Note:</b> The Spectrum Analyzer will not continue to measure RF signals while a USB device is connected. Exit the SignalHawk application prior to connecting a USB device to the SH-42S.
6	Charging port, 24 V, 5 A
7	Charge indicator, illuminates when charger is connected, red indicates charging, green indicates full charge
8	Display Screen, touch interaction, 5.5 inch, 1280 x 720.

## **Power Supply**

---

### **Internal Battery**

---

The SH-42S has an internal, rechargeable, lithium-ion battery pack that will operate the unit for 6 hours of continuous use. Recharging time, from a full discharge, is approximately 2.5 hours.

### **External AC Power Supply**

---

The AC to DC Power Supply (20 VDC, 4.5 A) is capable of charging the batteries in approximately 2 to 2.5 hours.

## Unpacking and Inspection

---

1. Carefully inspect shipping container for signs of damage.
  - If the shipping container is damaged, do not unpack the unit. Immediately notify the shipping carrier and Bird Technologies.
  - If the shipping container is not damaged, unpack the unit. Save shipping materials for repackaging.
2. Inspect unit for visual signs of damage.

**Note:** *If there is damage, immediately notify the shipping carrier and Bird Technologies.*

## Preparation for Use

---

### Power Requirements

---

The SignalHawk's battery charger requires AC input power of 100-240 V, 1.5 A, 50-60 Hz. The unit may be operated while connected to the charger.

### Charge the Battery

---

It is recommended that the batteries be charged before initial use.

1. Connect the battery charger to the SignalHawk.
2. Plug the battery charger into an AC outlet.

The SignalHawk will operate for 6 hours on a fully charged battery. The battery's level of charge is indicated on the Spectrum Analyzer display, see "[Charge Indicator](#)" on page 11.

## RF Connections

---

### Maximum Signal Levels

---

**CAUTION**

Do not exceed maximum input power levels.  
Exceeding the maximum input will damage the SignalHawk.  
If unsure of power levels, measure the test connection with a power sensor before using the SignalHawk.

The maximum input power level will vary with the selected pre-amp setting. The SH-42S has the following pre-amp settings:

<i>Pre-amp Setting</i>	<i>Gain</i>	<i>Upper Measurement Range Level</i>	<i>Maximum Input Power Level (Damage Level)</i>
Off	N/A	+20 dBm	30 dBm
1 On	20 dB	-20 dBm	0 dBm
2 On	40 dB	-40 dBm	-20 dBm

### Test Connection Setup

---

**WARNING**

Leaking RF energy is a potential health hazard. Never attempt to connect or disconnect equipment from the transmission line while RF power is being applied. Severe burns, electrical shock, or death can occur.

1. Measure the output power of the system being tested, or signal power, at the system's test port using a power meter, service monitor, or equivalent.  
**Note:** *Ensure the output power is less than the maximum power for the selected sensitivity setting.*
2. Connect the SignalHawk's "RF Input" connector:
  - For low-power applications, connect directly to the output of the signal source. See [Figure 2 on page 7](#).
  - For high-power applications, use a directional coupler or attenuator to reduce the output level of the signal source. See [Figure 3 on page 7](#).

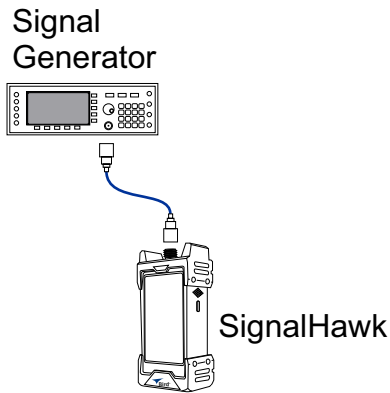
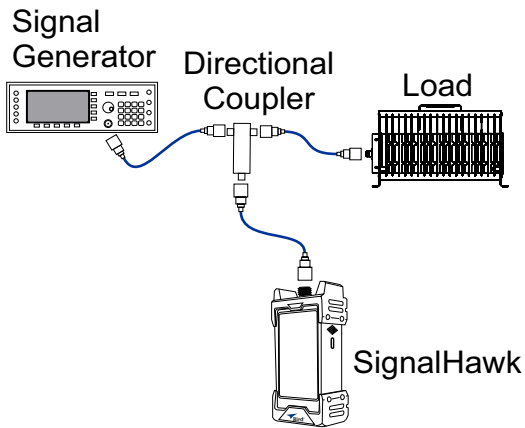

**Figure 2 Low Power Connection Example****Figure 3 High Power Connection Example**

## Power On

Power on the unit by pressing the power button for about one second.

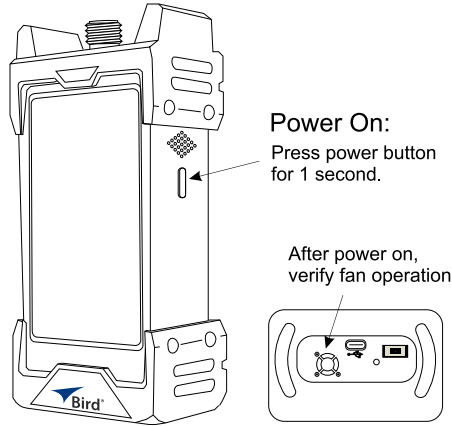

**CAUTION**

Do not block airflow to fan or air vents.  
Unit will overheat if the fan is not circulating air through the unit.

Verify the fan is operating after the unit is powered on.

## Viewing a Signal

1. Connect Signal Generator to the SH-42S. See ["RF Connections" on page 6](#).
2. Set signal generator to generate a CW signal at 1 GHz and 0.0 dBm
3. Tap **REF** and select 10 dBm with the rotary dial, then tap OK.
4. Tap **Center** and type 1, select GHz, then tap OK.
5. Tap **Span** and type 10, select MHz, then tap OK.
6. Tap **Peak Search** to display Marker 1 at the top of the signal peak.

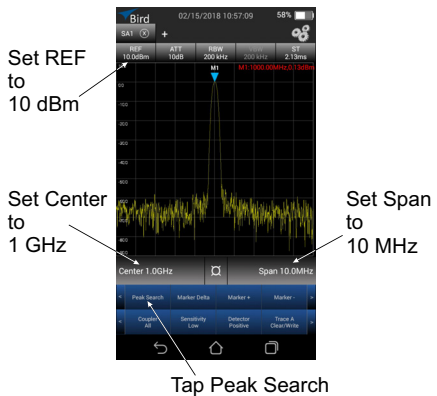

## Using a USB Device

---

The Spectrum Analyzer will not continue to measure RF signals and the application may “hang up” while a USB device is connected. Exit the SignalHawk application prior to connecting a USB drive to the SH-42S.

If a USB device was connected while the SignalHawk app was operating, the app will cease spectrum measurement. Once the USB device is disconnected, exit the app, restart the SignalHawk app from the home screen.

## Power Off

---

### Normal Power Off

---

1. Press and hold the power button for 4 seconds.
2. Tap the shutdown icon on the display.
3. Tap the confirmation icon on the display.

### Forced Power Off

---

1. Press and hold the power button for 15 seconds.
2. Tap the confirmation icon on the display.

The SH-42S operates on the Android Operating System, the Spectrum Analyzer launches as soon as the unit is powered on, this section describes the elements of the [User Interface](#), explains the methods used for [Data Entry/Display Controls](#), and provides details about the Spectrum Analyzer’s [System Settings](#).

## User Interface

The SignalHawk SH-42S user interface consists of a touch screen interface. The user taps the screen to access menus, change settings, perform measurements and save results.

**Figure 4 User Interface Description**

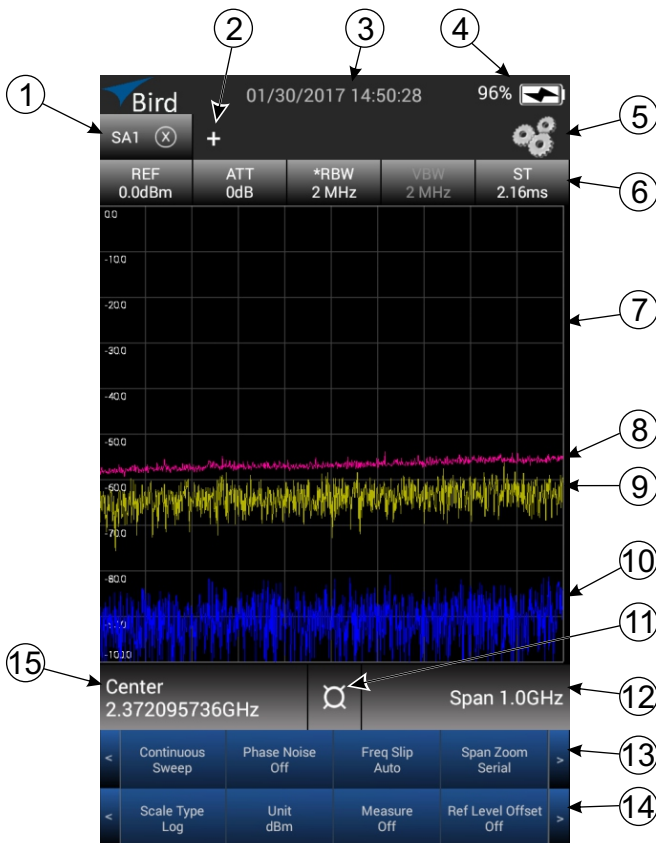

<b>Item</b>	<b>Control</b>	<b>Description</b>
1	SA Tab	The SH-42S is capable of displaying four Spectrum Analyzer tabbed windows. Each tab can be configured independently of the other tabs. Tabs are added by tapping the Add Tab symbol (+), see item 2. Tap the tab of the SA window you want to view.
2	Add Tab	When tapped, adds a new Spectrum Analyzer tabbed window. Each tab is numbered SA1, SA2, etc. Up to four windows can be added to the display.
3	Date & Time	Date and Time, press to change time or format.
4	Charge Indicator	The charge indicator provides a visual indication of remaining battery charge. When the charger is connected the indicator contains a charging symbol to indicate the battery is charging.
5	System Settings	System Settings menu provides access to options such as loading presets, saving and recalling settings, screen shots, printing, service, and device information. See " <a href="#">System Settings</a> " on <a href="#">page 18</a> .
6	Reference Level	Sets the value at the top of the y-axis of the graph.
	Attenuation	Controls the built-in attenuator on the signal input. It reduces the amplitude of a high-powered signal. The attenuation can be set to Auto, or at levels from 1 to 30 dB, at 1 dB steps. The reported value of the signal is automatically corrected for the selected attenuation. <b>Note:</b> An Astrix (*) by this value indicates a manual setting, and no longer Auto-Coupled, see Coupler (14).
	Resolution Bandwidth	Provides selection of automatic resolution bandwidth (RBW) or manual control of RBW. In automatic, RBW is based on the current frequency span. When the frequency span is reduced, the RBW will also be reduced accordingly. If the RBW is manually changed, the mode will switch to manual. See " <a href="#">Resolution Bandwidth</a> " on <a href="#">page 24</a> . <b>Note:</b> An Astrix (*) by this value indicates a manual setting, and no longer Auto-Coupled, see Coupler (14).
	Video Bandwidth	Displays the value of the Video Bandwidth setting. This is not user settable, but will update with changes to RBW.
	Sweep Time	Specifies the sweep time used in measuring the power. <b>Note:</b> An Astrix (*) by this value indicates a manual setting, and no longer Auto-Coupled, see Coupler (14).
7	Display area	Sweep display area.

<b>Item</b>	<b>Control</b>	<b>Description</b>
<b>8</b>	Trace C	Optional trace, may be displayed alone or with other traces also displayed.
<b>9</b>	Trace A	Default trace, automatically displayed when the Spectrum Analyzer is started. Two additional traces may be displayed, see item 8 and 10.
<b>10</b>	Trace B	Optional trace, may be displayed alone or with other traces also displayed.
<b>11</b>	Frequency Display Selector	When tapped, changes the displayed frequency values to or from Center/Span or Start/Stop.
<b>12</b>	Span/Stop Frequency	Displays either the Frequency Span or the Stop Frequency depending on the selection made by the frequency display selector (11). The frequency may be changed by tapping the value and entering a new value in the dialog.

<i>Item</i>	<i>Control</i>	<i>Description</i>
13	Peak Search	When tapped, positions the active marker at the point the displayed signal has the largest signal strength. If there is not an active marker, marker 1 will be added and moved to the signal peak.
	Marker Delta	When tapped, marker 1 becomes the reference marker, and all other markers display the difference in frequency and power from marker 1.
	Marker +	When tapped, adds a marker to the display.
	Marker -	When tapped, removes the highest numbered marker from the display.
	Single Sweep	When tapped, performs a single sweep and displays the results on the screen. To update the display tap single sweep again, or tap <b>Continuous Sweep</b> .
	Continuous Sweep	When tapped, performs one sweep after another displaying each sweep on the screen.
	Phase Noise	Phase noise option uses delta markers to measure phase noise. The option uses a reference marker to measure signal power and a delta marker to measure noise power, the phase noise ratio is displayed in dBc. See " <a href="#">Phase Noise Measurement</a> " on page <a href="#">32</a> .
	Freq Slip	Freq Slip is used to set the step size, in frequency, when the display is moved (swiped) left or right.
	Span Zoom	When tapped, toggles the Span Zoom option, between <b>Auto</b> and <b>Serial</b> . Span Zoom controls the step size of frequency span changes when screen is pinched (open or closed). When set to Auto, pinching the screen (open or closed) will change the span in finite steps. When set to Serial, pinching the screen (open or closed) will change the span in large increments/decrements.

<i>Item</i>	<i>Control</i>	<i>Description</i>
<b>14</b>	Coupler	Auto Couple function, options are <b>All, RBW, VBW, Sweep Time, and ATT</b> . Sets the selected parameter (RBW, VBW, ATT, Sweep Time, or All parameters) to auto. In auto, the parameters are automatically adjusted to optimize the measured signal. See " <a href="#">Automatic/Coupled Settings</a> " on page 22.
	Pre Amp	Selects pre-amp operation, options are <b>All Off, 1 On, All On</b> . Pre-amps should be chosen according to the power level of the measured signal. Changes to this parameter will change the maximum signal input power capability of the Spectrum Analyzer. See " <a href="#">Maximum Signal Levels</a> " on page 6 and " <a href="#">Pre-Amplification for low level signals</a> " on page 25.
	Detector	Allows the selection of the detector model used by the spectrum Analyzer. The options available are <b>Positive, Negative, Sample, Average, RMS</b> . See " <a href="#">Detector Settings</a> " on page 26.
	Trace A	Provides options for displaying Trace A, trace A defaults to <b>Clear/Write</b> . This option can be used to <b>Hide</b> Trace A, or set it to <b>MaxHold, MinHold, or Average</b> . When set to <b>Average</b> , the average sweep count is displayed and may be manually changed.
	Trace B	Provides options for displaying Trace B, trace B defaults to <b>Hide</b> . This option can be used to <b>Clear/Write</b> Trace B, or set it to <b>MaxHold, MinHold, or Average</b> . When set to <b>Average</b> the average sweep count is displayed and may be manually changed.
	Trace C	Provides options for displaying Trace C, trace C defaults to <b>Hide</b> . This option can be used to <b>ClearWrite</b> Trace C, or set it to <b>MaxHold, MinHold, or Average</b> . When set to <b>Average</b> the average sweep count is displayed and may be manually changed.
	Trigger	Selects the trigger mode of the Spectrum Analyzer.
	Calibration	Alternate action button used to turn Calibration on or off.
	Scale Type	Selects between Log (logarithmic) or Lin (Linear) for the Y-axis scale. When set to Log, the scale is set to dB, and each division is an equal value. When Lin is selected, the scale is set to volts, the bottom of the display is set to 0 volts and the top is set to the reference level, each division is 1/10 of full scale.
	Unit	Selects the unit of measurement displayed on the y-axis.
Measure	Allows the selection of preprogrammed measurement functions. Options include <b>ACPR</b> (Adjacent Channel Power), <b>CH Power, OBW</b> (Occupied Bandwidth), <b>N dB Down</b> . See " <a href="#">Measurements</a> " on page 27.	



<i>Item</i>	<i>Control</i>	<i>Description</i>
<b>14</b> Cont.	Ref Level Offset	When tapped, toggles the Ref Level Offset on and off. The Ref Level Offset is changed by tapping the value in the signal display area.
<b>15</b>	Center/Start Frequency	Displays either the Center Frequency or the Start Frequency depending on the selection made by the frequency display selector (11). The frequency may be changed by tapping the value and entering a new value in the dialog.

## Data Entry/Display Controls

A variety of controls are used for adjusting settings on the SH-42S.

### Rotary Dial Adjustments

Rotary dials ([Figure 5](#)) are used to adjust some settings.

To change a setting:

1. Press the screen and drag the dial right or left to the desired setting, the dial will settle on the closest hash mark. The selected value will be shown at the top of the dialog box.
2. Tap OK to save the new setting.

**Figure 5 Rotary Dial Adjustment**

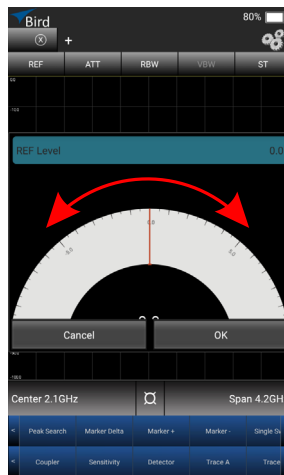

## Selection List Adjustments

Selection lists ([Figure 6](#)) are another method used to adjust settings on the SH-42S.

To change a setting:

1. swipe the list up or down until the desired setting is within the selection box at the center of the dialog.  
The selected value will be shown at the top of the dialog box.
2. Tap OK to save the new setting.

**Figure 6 Selection List Adjustments**



## Direct Data Entry Adjustments

Direct data entry ([Figure 7](#)) is also used in the SH-42S for adjusting settings.

To change a setting:

1. Tap the keypad to enter the desired value.
2. Select the appropriate unit for the new value.
3. Tap Enter to save the new setting.

**Figure 7** Data Entry Adjustments

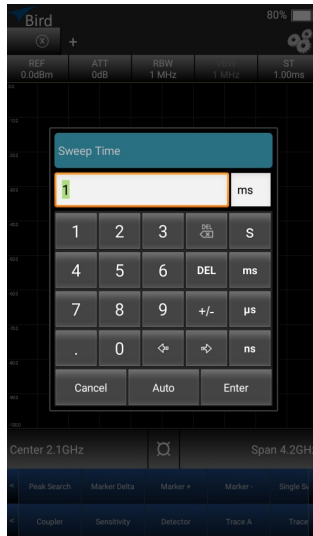

## System Settings

The System Settings menu provides options for selecting language, saving and recalling presets, selecting the startup state, and creating screen captures.

**Figure 8 System settings**



## Startup State

There are two options available for the spectrum analyzer state when the system is initialized:

- Save Current Settings - the Spectrum Analyzer starts in the same configuration in use when the system was shutdown.
- Reset to Factory Default - the Spectrum Analyzer starts with factory default settings, see "[Factory Default Settings](#)" on page 19.

To change Startup State:

1. Tap System Settings Icon, see [Figure 8](#).
2. Tap Startup State.
3. Select **Save Current Settings** or **Reset to Factory Default**.

## Factory Default Settings

<b><i>Parameter</i></b>	<b><i>Default Setting</i></b>
Center Frequency	2.1 GHz
Start Frequency	0.0 Hz
Stop Frequency	4.2 GHz
Span	4.2 GHz
Reference Level	0.0 dBm
Attenuation	Auto (0 dB)
RBW	Auto (5 MHz)
VBW	Auto (1 MHz), not user selectable
Sweep time	Auto
Marker	All Off
Sweep Mode	Continuous
Phase Noise	Off
Freq Slip	Auto
Span Zoom	Auto
Coupler	All
Pre-amp	All Off
Detector	Positive
Trace A	Clear/Write
Trace B	Hide
Trace C	Hide
Trigger	Free
Calibration	On
Scale Type	Log
Unit	dBm
Measure	Off
Reference Level Offset	Of
Scale/DIV	10 dB/DIV

## Custom Configuration

---

The System Settings menu allows the user to save a preferred setup (custom configuration) for repeated use. Custom configurations may be recalled at any time.

Custom configurations are saved in XML format in the Spec An folder on the device.

### Save a Custom configuration

To save the current configuration:

1. Tap System Settings Icon, see [Figure 8 on page 18](#).
2. Tap Save.
3. Type a filename in the Save dialog box.
4. Tap OK

### Recall a Custom configuration

To recall a custom configuration:

1. Tap System Settings Icon, see [Figure 8 on page 18](#).
2. Tap Recall.
3. Select the desired custom configuration from the displayed list.
4. Tap OK

## Screen Captures

---

There are two options for outputting screen captures on the System Settings menu, **Screen Copy** and **Print**.

The Screen Copy option creates a full color copy of the current display, while the Print option creates a black and white copy of the current display.

Screen Captures are saved in PNG format in the Spec An folder on the device.

To create a screen capture:

1. Tap System Settings Icon, see [Figure 8 on page 18](#).
2. Tap Screen Copy (color) or Print (black and white).
3. Type a filename in the dialog box.
4. Tap OK

## Languages

---

The System Settings menu contains an option for selecting the language displayed within the SignalHawk application.

To change the language used in the SignalHawk App:

1. Tap System Settings Icon, see [Figure 8 on page 18](#).
2. Tap Language.
3. Select the desired language.

There are a number of settings that may require adjustment to properly view and measure signals of interest. Many of these settings must be made in combination depending on the type and level of the signal. The following information is provided to aid in understanding these settings.

## Automatic/Coupled Settings

---

In the factory default settings, the following options are coupled together and automatically adjust when changes to are made frequency span:

- Attenuation
- Resolution Bandwidth (RBW)
- Sweep Time

When an RF signal is applied to the SH-42S, and changes are made to the frequency span, RBW and sweep time are automatically adjusted to provide a standardized view of the visible spectrum.

Manual adjustments may be required to effectively view some signals, when manual adjustments are made an asterisk (\*) will be displayed beside the setting to indicate a manual setting.

**Figure 9** *Manual Setting Indicator*

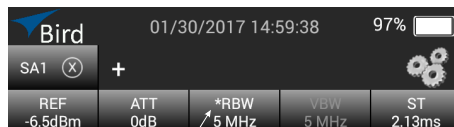

An Asterisk (\*)  
indicates a manual setting



## Resetting coupled settings to auto

If Attenuation, RBW, or Sweep time have been set manually they can be reset to automatic operation using the Coupler setting.

1. Tap Coupler
2. Select the specific setting to reset to auto or select ALL.

**Figure 10 Coupler Reset**

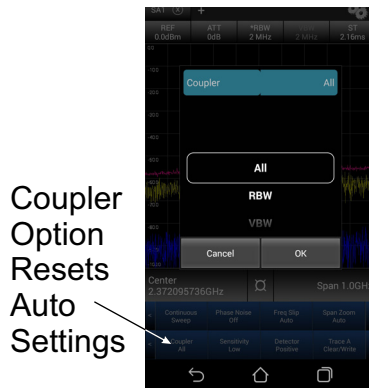

## Resolution Bandwidth

The Resolution Bandwidth (RBW) of a spectrum analyzer determines the smallest resolvable frequency separation. The easiest way to understand how RBW affects the trace shown on a spectrum analyzer is to think of RBW as the width of spectrum that is analyzed in one step. In this analogy, using a wider RBW analyzes a larger portion of spectrum at once and completes the entire sweep in less time, but will reduce trace detail. If the RBW is wider than the frequency separation of two signals, then both signals will be analyzed within the bandwidth and the spectrum analyzer will display only one apparent signal on the screen. If the RBW is equal to the frequency separation of the two signals, a 3dB dip between the two signals will appear.

**Figure 11** Signal Resolution and RBW

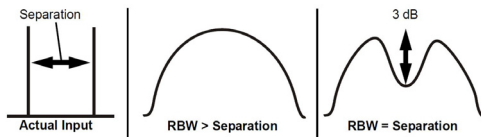

As the RBW decreases, more and more resolution between the two signals will be seen, and consequently, one full sweep over the set span will take longer to complete. It is important to note, however, that RBW can be too narrow in some instances. For example, if the RBW is not wide enough to include the sidebands of a modulated signal, the spectrum analyzer will display an inaccurate measurement.

Additionally, as RBW decreases, the amount of uncorrelated noise power decreases, and this reduces the Displayed Average Noise Level (DANL) seen on the spectrum analyzer. The DANL, or Noise Floor, of a spectrum analyzer determines the lowest possible signal level that can be measured by the unit. For example, if one is attempting to measure a signal that is -130dBm, the spectrum analyzer must have a DANL that is lower than -130dBm.

The SH-42S is capable of measuring low-level signals, however, it should be understood that the sweep time will be very long based on the settings used to obtain the DANL specification. Changing RBW in order to decrease the sweep time will also increase the DANL. In general, if the span is kept constant, sweep time will be increased by decreasing RBW and using more data points.

## Pre-Amplification for low level signals

The SH-42s includes built-in low-noise amplifiers on the signal input. Because the spectrum analyzer's internal noise is a constant and is generated by the circuitry following the pre-amps, the DANL of the unit can be lowered by amplifying the incoming signal, then compensating for the applied internal pre-amp gain.

The SH-42S has three pre-amp settings:

<b><i>Pre-amp Setting</i></b>	<b><i>Gain</i></b>	<b><i>Upper Measurement Range Level</i></b>	<b><i>Maximum Input Power Level (Damage Level)</i></b>
Off	N/A	+20 dBm	30 dBm
1 On	20 dB	-20 dBm	0 dBm
2 On	40 dB	-40 dBm	-20 dBm

For example, a -30dBm signal is passed through the internal pre-amp having a 20 dB gain, the resulting signal would display at a level of -10 dBm without compensation. However, since the pre-amp is internal to the spectrum analyzer, this displayed signal is automatically corrected to the original -30 dBm value.

Consequently, if the internal noise of the spectrum analyzer following the pre-amp is -110dBm, it displays at a level of -134dBm once the 20 dB correction is applied.

If there is no signal injected into the spectrum analyzer, then the effective DANL is lowered by approximately the amount of internal pre-amp gain applied.

Be very careful when using the spectrum analyzer's internal pre-amps, applying too much power to the unit could cause internal damage, as shown above.

## Detector Settings

Each detector measurement period (or pixel) displayed on the trace is a measurement output of the spectrum analyzers detector.

The SH-42S has the following detector settings:

- Positive: Returns the maximum value of the data collected for each display pixel. Recommended for pure sine waves or narrow bandwidth signals.
- Negative: Returns the minimum value of the data collected for each display pixel. Recommended for displaying the difference between CW and pulsed signals.
- Sample: Returns a sample of the data collected for each display pixel.
- Average: Returns the linear average of the data collected for each display pixel. Recommended for Channel Power measurements.
- RMS: Returns the RMS average of the data collected for each display pixel. Use this method for detecting noise-like signals.

**Figure 12** *Detector Operation*

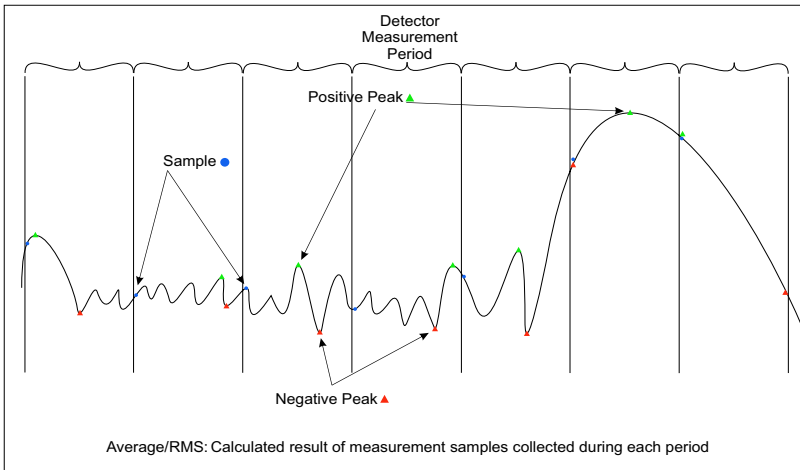

For low-level signal detection, setting the Detector to Average or RMS displays the average of the raw data collected for each display pixel. This is recommended for noise-reduction, since averaging the multiple raw data samples collected for each data point makes the resulting measurement less sensitive to noise. The number of raw data samples collected by Bird's SignalHawk is controlled by a combination of the RBW, VBW, and the frequency span settings.

The SH-42S includes several preprogrammed measurement functions, including Adjacent Channel Power (ACPR), Channel Power (CH Power), Occupied Bandwidth (OBW), and N dB Down. Phase Noise measurements may also be made automatically with the SignalHawk spectrum Analyzer.

The Bird RF Meter App makes RF power measurement possible when a Bird power sensor is connected to the SH-42S.

### Adjacent Channel Power Measurement

Adjacent Channel Power measures the relative power of frequency bands adjacent to a central channel. This is often used to identify power leakage from the center channel into the adjacent channels. The total power in the center (main) channel is displayed in dBm and the power in the adjacent channels (Lower and Upper) are given in dBc and dBm.

Figure 13 Adjacent Channel Power

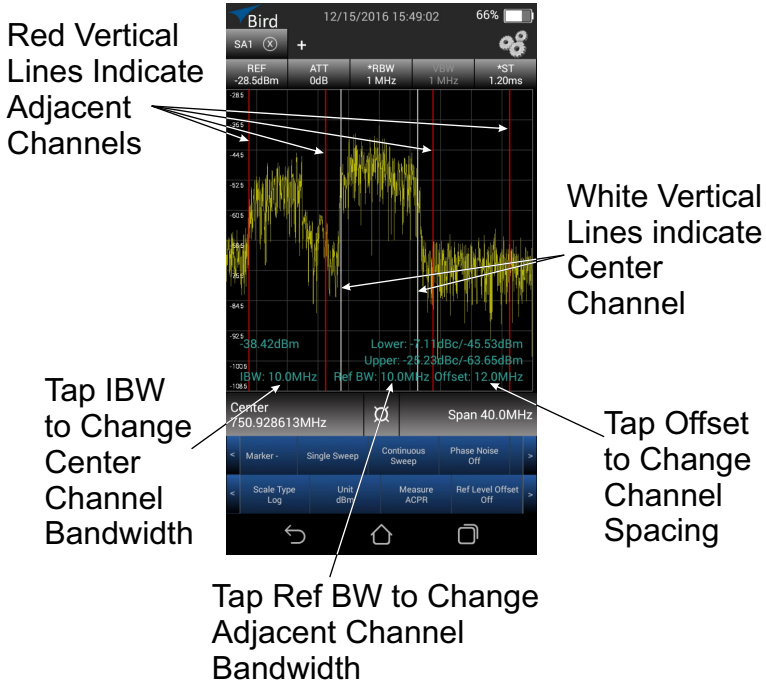

## ACPR Setup

---

1. For best accuracy, set the central frequency so the signal is centered before taking measurements.
2. Select ACPR in the Measure menu.
3. Tap IBW at the bottom of the screen to set the width of the central channel.

**Note:** *The central channel can be set to a different frequency width than the adjacent channels, but both adjacent channels have the same width.*

4. Tap Ref BW to set the width of both adjacent channels.
5. Tap Offset to set the Center-to-Center channel spacing.

**Note:** *Channel spacing is the distance from the central channel's center frequency to the adjacent channel's center frequency. If there is no guard band between channels, the channel spacing should be half (channel width + adjacent channel width).*

White and red vertical lines are used to mark the edges of the central, upper, and lower channels.

The Center Channel power will be displayed on the left side of the display. The power for the Lower and Upper Adjacent Channels will be displayed on the right side of the display.

## Channel Power Measurement

Channel Power measures the Integration Bandwidth, the total power over a frequency range, concentrated on the center frequency of the sweep. It is useful for channelized (frequency-division multiplexed) signals. Results are shown in both total power in the channel (in dBm or Watts), and spectral density (dBm or Watts per Hz).

**Figure 14 Channel Power Measurement**

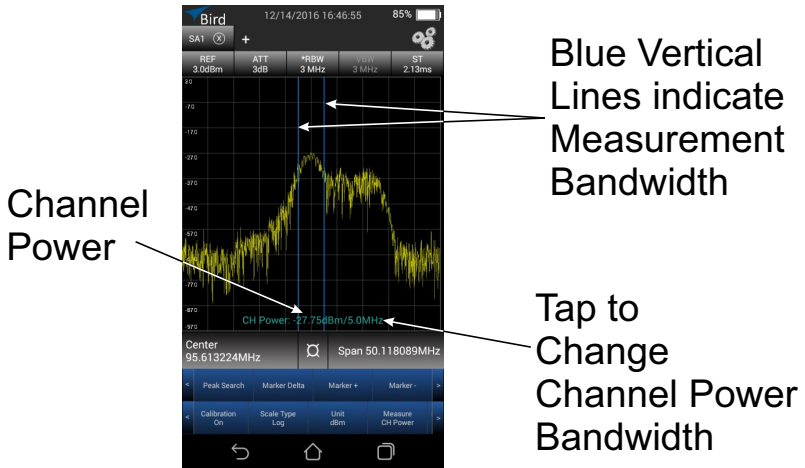

## Channel Power Setup

1. For best accuracy, set the center frequency so the signal is roughly centered before taking measurements. In addition, the span should be  $1\frac{1}{2}$  – 5 times as large as the desired channel width.
2. Select CH Power in the Measure menu.

The Channel Power and the measured bandwidth will be displayed in the area at the bottom of the display.

3. Tap CH Power at the bottom of the screen to change the measured bandwidth.

Vertical Blue lines will mark the edges of the measured band.

## Occupied Bandwidth Measurement

Occupied Bandwidth measures the frequency band bandwidth that contains a specified percentage of the total power of the signal.

It gives best results with single-peaked signals. Bandwidth measurement results are in Hz units.

**Figure 15 Occupied Bandwidth Measurement**

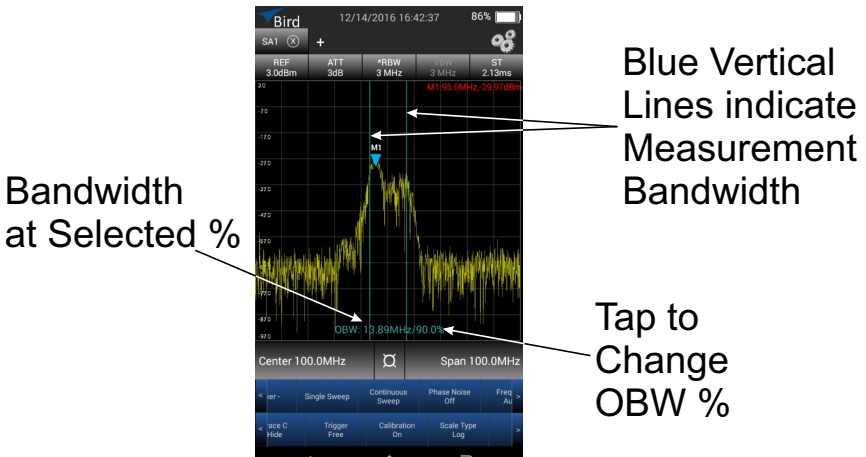

The calculated occupied bandwidth represents the user specified percent of the total power of the displayed span.

## Occupied Bandwidth Setup

1. For the best accuracy, set the center frequency so the main or carrier signal is centered on the screen before taking measurements.
2. Select OBW in the Measure menu.

The threshold and the measured bandwidth will be displayed in the area at the bottom of the display.

3. Tap OBW at the bottom of the display to change the percentage of signal to be measured.

Vertical Blue lines will mark the edges of the measured band.



## N dB Down Measurement

N dB Down measures the frequency bandwidth at a user selected value in decibels below the signal peak. Bandwidth measurement results are in Hz units.

**Figure 16** N dB Down Measurement

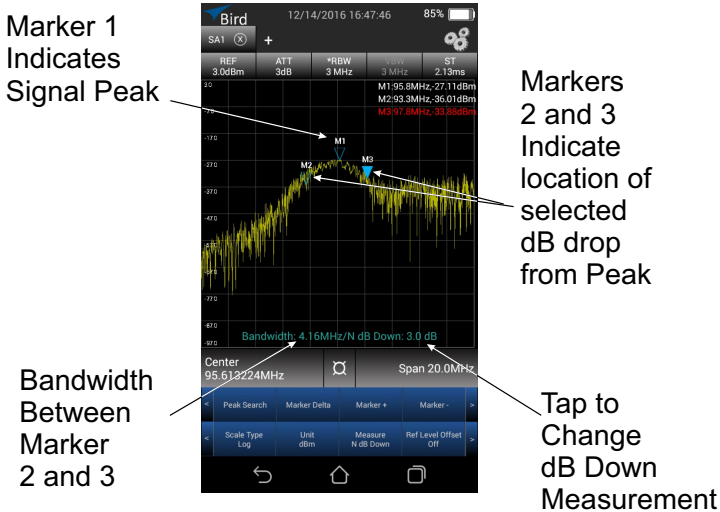

## N dB Down Setup

1. For the best accuracy, set the center frequency so the main or carrier signal is centered on the screen before taking measurements.
2. Select N db Down in the Measure menu.

The threshold and the measured bandwidth will be displayed in the area at the bottom of the display.

3. Tap N db Down at the bottom of the screen to change the decibel level down from the signal peak to be measured.

Markers 2 and 3 are used to indicate the edges of the measured bandwidth.

## Phase Noise Measurement

Due to signal amplitude and phase fluctuations present in even the highest quality systems there are sidebands created which appear as noise spreading out above and below the carrier.

Phase noise is important because it can reduce signal quality possibly increasing the communications link's error rate.

The SH-42s provides a tool to quickly measure phase noise at a user specified frequency above or below the carrier. A marker is used to measure the carrier power, a delta marker is used to display the difference in frequency and power from the carrier, and the Phase Noise is displayed in dBc/Hz at the location of the delta marker. The Phase Noise is the noise power in a 1 Hz bandwidth at the offset from the carrier.

**Figure 17 Phase Noise Measurement**

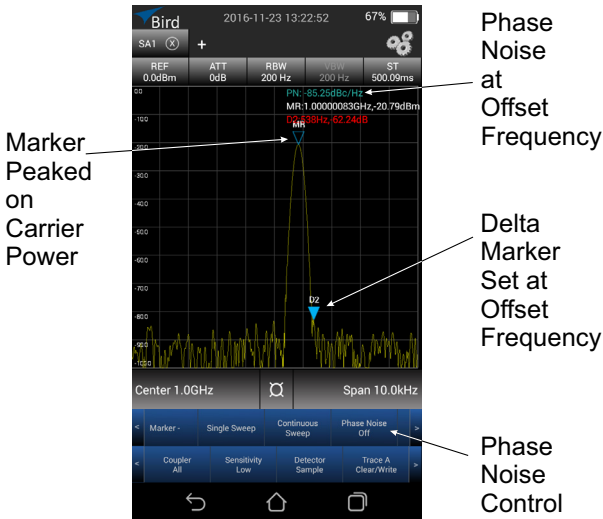

## Phase Noise Setup

1. For the best accuracy, set the center frequency so the main or carrier signal is centered on the screen before taking measurements.
2. Tap Phase Noise control to turn on the Phase Noise measurement.

The Carrier Marker and the Delta Marker will be displayed. Phase Noise and the Marker values will be displayed in the area at the top right of the display.

3. Position the markers as needed to measure Phase Noise.

## Power Measurements

**Note:** *The Spectrum Analyzer will not continue to measure RF signals while a USB Sensor is connected. Exit the SignalHawk application prior to connecting a USB Power Sensor to the SH-42S.*

The SH-42S is capable of making RF power measurements using the Bird RF Meter App when connected to a compatible Bird Power Sensor. The SH-42S may be connected to a Bird Power sensor using the supplied USB Adapter and the USB cable supplied with the power sensor, see [Figure 18](#). Consult the RF Meter App's help content for a list of compatible sensors and measurements that are available for each sensor.

The Bird RF Meter App is included with the SH-42S and may be started from the Home screen by tapping the App's icon: 

**Figure 18** *Power Sensor Connections*



## Cleaning

---

Care and cleanliness is a main factor in maintenance, clean the SH-42S with a soft cloth dampened with a mild detergent solution.

## Instrument Calibration

---

It is recommended that an instrument calibration be performed by a certified service provider at nominal one year intervals.

Contact Bird for more information. See "[Customer Service](#)" on [page 42](#).

## Troubleshooting

---

<i>Problem</i>	<i>Resolution</i>
Spectrum Analyzer "hangs up" with USB device connected to the SH-42S.	Once the USB device is disconnected, exit the app, restart the SignalHawk app from the home screen.

## Repair

---

### Battery Replacement

---

**CAUTION**

Replace battery pack with OEM part only, do not use any other battery.

1. Power off the SignalHawk. See "[Power Off](#)" on [page 9](#).
2. Disconnect AC Supply cable, if connected.
3. Remove four screws securing bottom rubber bumper. See [Figure 19](#).

### Figure 19 Rubber Bumper Removal

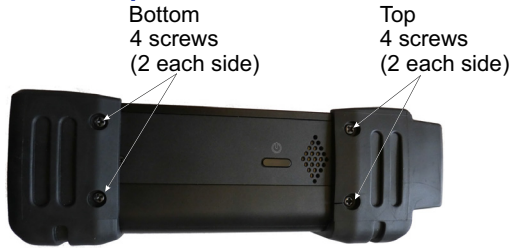

4. Remove four screws securing top rubber bumper. See [Figure 19](#).
5. Remove four screws securing the back cover. See [Figure 20 on page 35](#).

### Figure 20 Back Cover Removal



6. Disconnect battery connector from chassis. See [Figure 21](#).

### Figure 21 Battery Connection

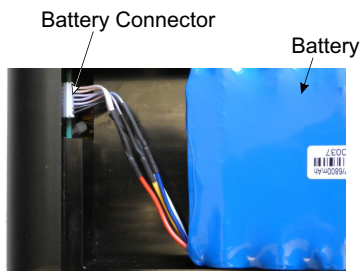

7. Install replacement battery.
8. Install four screws to secure the back cover. See [Figure 20](#).
9. Install four screws to secure top rubber bumper. See [Figure 19 on page 35](#).
10. Install four screws to secure bottom rubber bumper. See [Figure 19 on page 35](#).
11. Charge the battery. See ["Charge the Battery" on page 5](#).

## File System

---

The Spectrum Analyzer stores Screen Captures and Custom Configurations on the SH-42S internal file system.

### Transfer files

---

Files may be transferred to/from the SH-42S using a USB Drive or via Bluetooth transfer. For instructions on how to make transfers. see "[Data Transfer via USB Drive](#)" on page 36 or "[Data Transfer via Bluetooth](#)" on page 39.

### Data Transfer via USB Drive

**Note:** *The SH-42s will not continue to measure RF signals while a USB drive is connected. Exit the SignalHawk application prior to connecting a USB drive to the SH-42S.*

Files may be transferred to/from the SignalHawk internal memory with the use of an external USB drive and the USB adapter (supplied).

1. Connect the USB drive to the USB adapter, then connect the USB adapter to the USB-C port at the bottom of the unit.
2. Press Home key on the SignalHawk display.
3. Tap the File Manager icon on the unit's home screen.

### Figure 22 File Manager

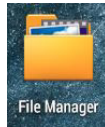

4. Tap LOCAL at the top of the File Manager window.
5. Tap Internal.
6. Scroll to the SpecAn folder, see [Figure 23](#).
7. Tap the SpecAn folder.

### Figure 23 File Selection

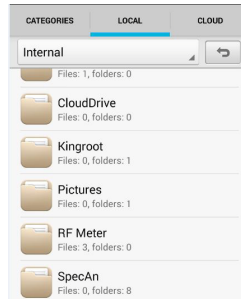

8. Tap the folder containing the file(s) to be moved.
  - Print - contains files printed from the Spectrum Analyzer.
  - Save - contains saved configuration files.
  - Screen copy - contains screen copies from the spectrum analyzer.
  - Manual - contains pdf copies of this manual.
9. Tap the Copy icon: 
10. Select the file(s) to be copied.
11. Tap COPY (X).
12. Tap the drop-down list at the top of the file manager and select Local.
13. Select USB storage.

**Figure 24 External Storage**

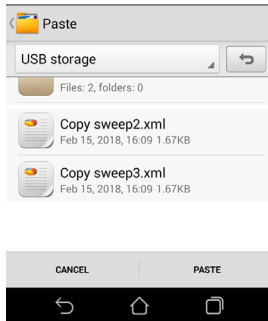

14. Navigate to the directory where the file will be saved.
15. Tap PASTE at the bottom of the screen to save the file(s) onto the USB drive.
16. Exit the File Manager.
17. Tap Settings on the Home Screen. See [Figure 25 on page 38](#).
18. Tap Storage, if the storage option is not available see ["Display Storage Option in Settings" on page 38](#).

Figure 25 Unmount USB Storage

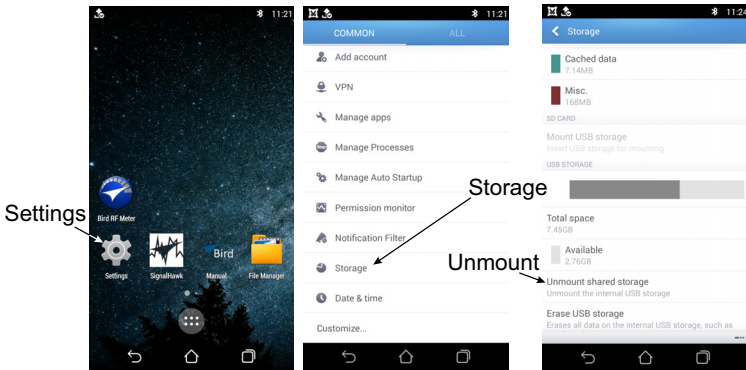

- 19. Scroll to SD Card, and tap Unmount shared storage.
- 20. Tap OK.
- 21. You may now remove the USB Drive.

### Display Storage Option in Settings

If the storage option is not visible in the Settings menu perform the following:

- 1. Tap Settings on the Home Screen. See [Figure 25 on page 38](#).
- 2. Tap Customize, see [Figure 25](#).

Figure 26 Customize Setting Menu

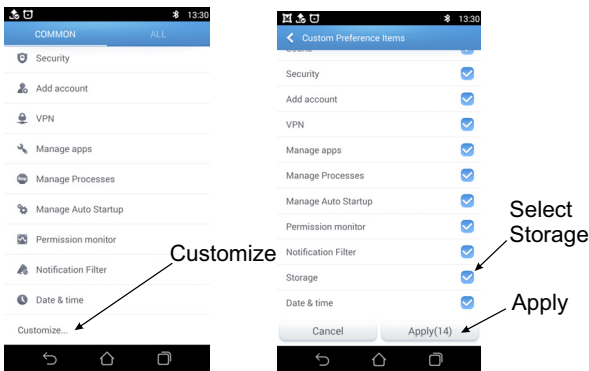

- 3. Select Storage.
- 4. Tap Apply.

The Storage option should now be visible in the Setting menu.



## Data Transfer via Bluetooth

Files may be transferred to/from the SignalHawk using the following steps.

1. Tap Home key on the SignalHawk display.
2. Select Settings.
3. Turn on Bluetooth.
4. Tap Home key.
5. Tap the File Manager icon on the unit's home screen.

**Figure 27 File Manager**

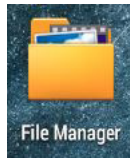

6. Tap LOCAL at the top of the File Manager window.
7. Tap Internal.
8. Scroll to the SpecAn folder, see [Figure 28](#).
9. Tap the SpecAn folder.

**Figure 28 File Selection**

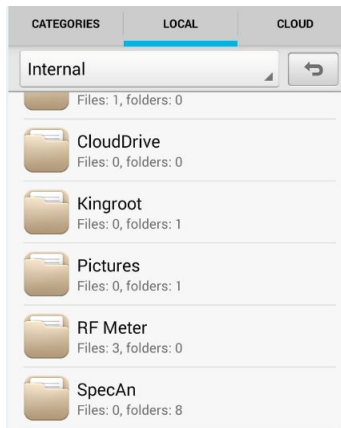

10. Tap the menu overflow icon  at the bottom of the screen.
11. Tap Share.
12. Select the file(s) to be copied.
13. Tap SHARE (X)
14. Select Bluetooth option for sharing.
15. Scan for available devices.

**Note:** You may need to make the destination device visible to other devices in it's setting's menu.

16. Select the destination device from the devices listed.
17. On the destination device, tap ACCEPT.
18. Verify transfer is complete.

## Delete Files

---

1. Press Home key on the SignalHawk display.
2. Tap the File Manager icon on the unit's home screen.

**Figure 29 File Manager**

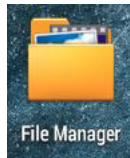

3. Tap LOCAL at the top of the File Manager window.
4. Tap Internal.
5. Scroll to the SpecAn folder, see [Figure 23](#).
6. Tap the SpecAn folder.

**Figure 30 File Selection**

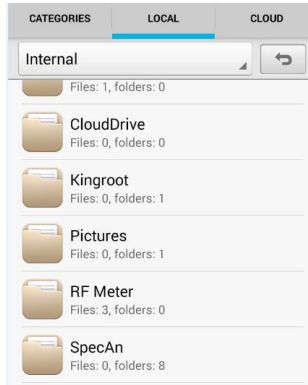

7. Tap the folder containing the file(s) to be deleted.
  - Print - contains files printed from the Spectrum Analyzer.
  - Save - contains saved configuration files.
  - Screen copy - contains screen copies from the spectrum analyzer.
  - Manual - contains pdf copies of this manual.

8. Tap the Delete icon: 
9. Select the file(s) to be deleted.
10. Tap DELETE (X).
11. Tap OK on the “are you sure” popup dialog to delete the files.

## Firmware Updates

---

Occasionally Bird may update the SH-42S spectrum analyzer software, updates may be downloaded when available from [www.birdrf.com](http://www.birdrf.com).

1. Go to [www.birdrf.com/Products/Test and Measurement/Analyzers/Spectrum-Analyzers/](http://www.birdrf.com/Products/Test%20and%20Measurement/Analyzers/Spectrum-Analyzers/).
2. Select SH-42S.
3. Scroll down to the Downloads.
4. Click on the Firmware link.
5. Download the SignalHawk-Firmware-XXX.apk update file.
6. Connect the USB Drive to the PC.
7. Transfer the SignalHawk-Firmware-XXX.apk update file to the USB drive.
8. Remove the USB drive.
9. Connect the USB drive to the USB Adapter.
10. Connect the USB Adapter to the SignalHawk.
11. Turn on the SignalHawk.
12. Connect AC Adapter to the SH-42S or verify battery has sufficient charge.
13. Tap “File Manager” on the home screen.
14. Tap LOCAL at the top of the File Manager window.
15. Tap “USB storage”.
16. Tap SignalHawk-Firmware-XXX.apk.
17. Follow the Installation instructions on the unit.

## Customer Service

---

Any maintenance or service procedure beyond the scope of those in this chapter should be referred to a qualified service center.

If the unit needs to be returned for any reason, request an Return Material Authorization (RMA) through the Bird Technologies website. All instruments returned must be shipped prepaid and to the attention of the RMA number.

### **Bird Service Center**

30303 Aurora Road  
Cleveland (Solon), Ohio 44139-2794  
Fax: (440) 248-5426  
E-mail: [bsc@birdrf.com](mailto:bsc@birdrf.com)

For the location of the Sales Office nearest you, visit our Web site at:

<http://www.birdrf.com>

## Signal Analysis Specifications

---

Frequency Range	10MHz to 4.2GHz
Frequency Reference Aging	±1ppm
Frequency Span Accuracy	±1%
Sweep Time	1.1ms ~ 1600s
Bandwidth Range	10 Hz ~ 5 MHz
Bandwidth Accuracy	≥1 MHz, ±10% <1 MHz, ±2%
Measurement Range	DANL to +20dBm
Input Attenuator Range	0~30dB, 1dB step
Max Safe Input Level vs. Pre-amp	
All Amps Off	+20 dBm
1 Amp On	-20 dBm
All Amps On	-40 dBm
Reference Level Range (Ref Level Offset: ON)	-140 dBm ~ +20 dBm -190 dBm ~ +70 dBm
Amplitude Accuracy	-5 to -30 dBm ±1.5 dBm
Switching Uncertainty	±0.3 dB
Input Attenuator	±0.6 dB
Reference Level Accuracy	≥-60dBm ±0.8dB
Average Noise Level Sensitivity	
All Amps Off - Low Power	1GHz, -131dBm/Hz, typical -133dBm/Hz
1 Amp On - Medium Power	1GHz, -151dBm/Hz, typical -153dBm/Hz
All Amps On - High Power	1GHz, -168dBm/Hz, typical -169dBm/Hz
Residual Responses	-75 dBm
Input Related Responses	-40 dBc
Second harmonic distortion	1.6GHz -70dBc
Third-Order Intercept (TOI) -	10 dBm +15dBm
P1dB	+5dBm Nominal
Phase Noise (1GHz)	-96dBc/Hz, @10kHz (typical -98dBc/Hz) -118dBc/Hz, @1MHz (typical -120dBc/Hz)

## Device Characteristics

---

### Instrument Calibration

---

Instrument Calibration Interval	one (1) year intervals
---------------------------------	------------------------

### Physical characteristics

---

Connectors RF In: USB: Power interface:	N type, female, 50 $\Omega$ USB type C Slim Tip, DC20V
Display	5.5 inch, 1280*720p
Battery Type:	Li-on
Battery Operating time:	3.5 to 6 hours
Battery Charging time:	2 to 2.5 hours
Operating Temperature:	0°C to 50°C
Storage Temperature:	-20°C to 70°C
Size	7.8 x 3.9 x 2.6 inches (200 x 99 x 67 mm)
Weight	2.3 - 2.8 lbs (1.05 - 1.25 kg)

### Software Characteristics

---

OS	Android
Languages	English, Chinese



# Limited Warranty

The product described in this manual is warranted to be free from defects in material and workmanship for a period of three (3) years, unless otherwise specified, from date of shipment and to conform to applicable specifications, drawings, blueprints and/or samples. Seller's sole obligation under these warranties shall be to issue credit, repair or replace any item or part thereof which is proved to be other than as warranted; no allowance shall be made for any labor charges of Buyer for replacement of parts, adjustment or repairs, or any other work, unless such charges are authorized in advance by Seller.

If Seller's products are claimed to be defective in material or workmanship or not to conform to specifications, drawings, blueprints and/or samples, Seller shall, upon prompt notice thereof, either examine the products where they are located or issue shipping instructions for return to Seller (transportation-charges prepaid by Buyer). In the event any of our products are proved to be other than as warranted, transportation costs (cheapest way) to and from Seller's plant, will be borne by Seller and reimbursement or credit will be made for amounts so expended by Buyer. Every such claim for breach of these warranties shall be deemed to be waived by Buyer unless made in writing within ten (10) days from the date of discovery of the defect.

The above warranties shall not extend to any products or parts thereof which have been subjected to any misuse or neglect, damaged by accident, rendered defective by reason of improper installation or by the performance of repairs or alterations outside of our plant, and shall not apply to any goods or parts thereof furnished by Buyer or acquired from others at Buyer's request and/or to Buyer's specifications. Routine (regularly required) calibration is not covered under this limited warranty. In addition, Seller's warranties do not extend to the failure of tubes, transistors, fuses and batteries, or to other equipment and parts manufactured by others except to the extent of the original manufacturer's warranty to Seller.

The obligations under the foregoing warranties are limited to the precise terms thereof. These warranties provide exclusive remedies, expressly in lieu of all other remedies including claims for special or consequential damages. SELLER NEITHER MAKES NOR ASSUMES ANY OTHER WARRANTY WHATSOEVER, WHETHER EXPRESS, STATUTORY, OR IMPLIED, INCLUDING WARRANTIES OF MERCHANTABILITY AND FITNESS, AND NO PERSON IS AUTHORIZED TO ASSUME FOR SELLER ANY OBLIGATION OR LIABILITY NOT STRICTLY IN ACCORDANCE WITH THE FOREGOING.