



NETWORK ENABLED
ANTENNA & CABLE MONITOR

ACMI SERIES

OPERATION MANUAL

©COPYRIGHT 2019 BY BIRD TECHNOLOGIES, INC.
INSTRUCTION BOOK P/N 920-ACMI REV. D
THRULINE® IS A REGISTERED TRADEMARK OF
BIRD ELECTRONIC CORPORATION

MICROSOFT® ARE REGISTERED TRADEMARKS OF THE MICROSOFT CORPORATION
ORACLE AND JAVA ARE REGISTERED TRADEMARKS OF ORACLE AND/OR ITS AFFILIATES.
GOOGLE AND GOOGLE CHROME™ BROWSER ARE REGISTERED TRADEMARKS OF GOOGLE INC.

Safety Precautions

The following are general safety precautions that are not necessarily related to any specific part or procedure, and do not necessarily appear elsewhere in this publication. These precautions must be thoroughly understood and apply to all phases of operation and maintenance.

WARNING

Keep Away From Live Circuits

Operating Personnel must at all times observe general safety precautions. Do not replace components or make adjustments to the inside of the test equipment with the high voltage supply turned on. To avoid casualties, always remove power.

WARNING

Shock Hazard

Do not attempt to remove the RF transmission line while RF power is present.

WARNING

Do Not Service Or Adjust Alone

Under no circumstances should any person reach into an enclosure for the purpose of service or adjustment of equipment except in the presence of someone who is capable of rendering aid.

WARNING

Safety Earth Ground

An uninterruptible earth safety ground must be supplied from the main power source to test instruments. Grounding one conductor of a two conductor power cable is not sufficient protection. Serious injury or death can occur if this grounding is not properly supplied.

WARNING

Resuscitation

Personnel working with or near high voltages should be familiar with modern methods of resuscitation.

WARNING

Remove Power

Observe general safety precautions. Do not open the instrument with the power on.

Safety Symbols

WARNING

Warning notes call attention to a procedure, which if not correctly performed, could result in personal injury.

CAUTION

Caution notes call attention to a procedure, which if not correctly performed, could result in damage to the instrument.

Note: *Calls attention to supplemental information.*

Warning Statements

The following safety warnings appear in the text where there is danger to operating and maintenance personnel, and are repeated here for emphasis.

WARNING

Leaking RF energy is a potential health hazard. Never attempt to connect or disconnect equipment from the transmission line while RF power is being applied. Severe burns, electrical shock, or death can occur.

See page 8.

WARNING

Do not touch the center conductor of the power monitor ports while RF power is being applied.

See page 9.

WARNING

Dangerous RF voltage. Do not connect or apply an RF signal to the ACMI during equipment setup. Failure to comply may result in severe burns, loss of use of limbs, or death.

See page 14.

WARNING

Do not connect RF power to the unit.

See page 14.

WARNING

Disconnect the unit from the RF power source and the AC line before any disassembly. The potential for electrical shock exists.

See page 31.

Caution Statements

The following equipment cautions appear in the text and are repeated here for emphasis.

CAUTION

The input voltage must be clean and stable. Be sure that the input voltage does not surge and does not contain spikes. Failure to comply may result in permanent damage to the instrument.

See page 10.

CAUTION

The maximum input voltage differential is 72 V for High Voltage models, 36 V for Medium Voltage models, and 18 V for Low Voltage Models. Do not apply an input voltage differential greater than the voltage limit for the model. Failure to comply may result in permanent damage to the instrument.

See page 10.

CAUTION

Network connections require specific address and protocol information. Have a qualified IT or network professional perform the ACMI Ethernet setup. Failure to comply may result in loss of network communication or the inability to communicate with the ACMI.

See page 13.

CAUTION

Do not use harsh or abrasive detergents for cleaning.

See page 31.

Safety Statements

USAGE

ANY USE OF THIS INSTRUMENT IN A MANNER NOT SPECIFIED BY THE MANUFACTURER MAY IMPAIR THE INSTRUMENT'S SAFETY PROTECTION.

USO

EL USO DE ESTE INSTRUMENTO DE MANERA NO ESPECIFICADA POR EL FABRICANTE, PUEDE ANULAR LA PROTECCIÓN DE SEGURIDAD DEL INSTRUMENTO.

BENUTZUNG

WIRD DAS GERÄT AUF ANDERE WEISE VERWENDET ALS VOM HERSTELLER BESCHRIEBEN, KANN DIE GERÄTESICHERHEIT BEEINTRÄCHTIGT WERDEN.

UTILISATION

TOUTE UTILISATION DE CET INSTRUMENT QUI N'EST PAS EXPLICITEMENT PRÉVUE PAR LE FABRICANT PEUT ENDOMMAGER LE DISPOSITIF DE PROTECTION DE L'INSTRUMENT.

IMPIEGO

QUALORA QUESTO STRUMENTO VENISSE UTILIZZATO IN MODO DIVERSO DA COME SPECIFICATO DAL PRODUTTORE LA PROZIONE DI SICUREZZA POTREBBE VENIRNE COMPROMESSA.

SERVICE

SERVICING INSTRUCTIONS ARE FOR USE BY SERVICE - TRAINED PERSONNEL ONLY. TO AVOID DANGEROUS ELECTRIC SHOCK, DO NOT PERFORM ANY SERVICING UNLESS QUALIFIED TO DO SO.

SERVICIO

LAS INSTRUCCIONES DE SERVICIO SON PARA USO EXCLUSIVO DEL PERSONAL DE SERVICIO CAPACITADO. PARA EVITAR EL PELIGRO DE DESCARGAS ELÉCTRICAS, NO REALICE NINGÚN SERVICIO A MENOS QUE ESTÉ CAPACITADO PARA HACERLO.

WARTUNG

ANWEISUNGEN FÜR DIE WARTUNG DES GERÄTES GELTEN NUR FÜR GESCHULTES FACHPERSONAL.

ZUR VERMEIDUNG GEFÄHRLICHE, ELEKTRISCHE SCHOCKS, SIND WARTUNGSARBEITEN AUSSCHLIEßLICH VON QUALIFIZIERTEM SERVICEPERSONAL DURCHZUFÜHREN.

ENTRETIEN

L'EMPLOI DES INSTRUCTIONS D'ENTRETIEN DOIT ÊTRE RÉSERVÉ AU PERSONNEL FORMÉ AUX OPÉRATIONS D'ENTRETIEN. POUR PRÉVENIR UN CHOC ÉLECTRIQUE DANGEREUX, NE PAS EFFECTUER D'ENTRETIEN SI L'ON N'A PAS ÉTÉ QUALIFIÉ POUR CE FAIRE.

ASSISTENZA TECNICA

LE ISTRUZIONI RELATIVE ALL'ASSISTENZA SONO PREVISTE ESCLUSIVAMENTE PER IL PERSONALE OPPORTUNAMENTE ADDESTRATO. PER EVITARE PERICOLOSE SCOSSE ELETTRICHE NON EFFETTUARE ALCUNA RIPARAZIONE A MENO CHE QUALIFICATI A FARLA.

Changes to this Manual

We have made every effort to ensure this manual is accurate. If you discover any errors, or if you have suggestions for improving this manual, please send your comments to our Solon, Ohio factory. This manual may be periodically updated. When inquiring about updates to this manual refer to the part number and revision on the title page.

Chapter Layout

Introduction — Identifies the parts and functions of the ACMI.

Theory of Operation — Describes the ACMI's alarm options.

Installation — Provides instructions for installing the ACMI at a site, as well as detailed information on the cable connections.

Operating Instructions — Explains computer commands for controlling the ACMI and describes operation of the Web Tool software.

Maintenance — Lists routine maintenance tasks for the ACMI, as well as troubleshooting information for common problems. Specifications and parts lists are also included.

TABLE OF CONTENTS

Safety Precautions	i
Safety Symbols	ii
Warning Statements	iii
Caution Statements	iv
Safety Statements	v
About This Manual	vii
Changes to this Manual	viii
Chapter Layout	viii
Chapter 1 Introduction	1
Features	1
Items Supplied	2
Optional Accessories	2
Component Description	3
Chapter 2 Theory of Operation.	5
Alarm Response	5
Alarm Reset	5
Alarm Latching	5
VSWR Alarm	6
Alarm on Zero Power	6
High Power Alarm	6
Low Power Alarm	6
Push-to-Talk	7
Chapter 3 Installation	8
Unpacking and Inspection	8
Mounting	8
Cable Connections	8
Power/Alarm Connector	10

Panel Mount	12
Installation	12
Ethernet Connector	12
Web Tool Software	18
Computer Requirements	18
Chapter 4 Operating Instructions	19
Web Tool Software	19
Main Screen	19
Stats Screen	20
Config Screen	24
Admin Screen	26
Help Screen	29
Push-to-Talk	29
Analog Output Gain	30
Chapter 5 Maintenance	31
Inspection and Cleaning	31
Troubleshooting	32
Customer Service	32
Specifications	33
General	33
Frequency Range	34
RF Power Range	34
Accuracy	34
Insertion Loss, Max.	34
VSWR, Max.	34
Safety	35
Replacement Parts	35
Limited Warranty	36

Designed for 50 ohm coaxial transmission lines, the Bird Antenna & Cable Monitor is the solution for monitoring transmission antenna systems. Service providers and end users can rely on it to keep their critical sites up and running. Designed to detect antenna and cable faults that transmitter-internal VSWR monitors may not detect, it also provides accurate in-line power measurement functionality.

Features

- Measures forward and reflected power as well as VSWR and Return Loss.
- Measures true average power of pulses with high peak-to-average ratios - works with any modulation.
- When monitoring transmitter output power, alarms available for low or high power.
- Accurately monitors antenna and cable system VSWR. Alarm triggered if antenna or cable fails.
- Integral coupler measures small changes in VSWR through high feeder and interface losses.

Note: *High directivity maximizes measurement accuracy.*

- Sampling ports allow signal measurements without requiring system downtime.
- Excellent passive intermod allows the unit to be inserted into multichannel systems with a single Tx/Rx antenna with no desensing or degradation of receiver performance.
- Can be rack mounted at the output of transmitter combiner or linear power amplifier.
- Setup and operation via built-in Web Tool (P/O firmware).

Items Supplied

- ACMI Unit
- Instruction Manual

Optional Accessories

Note: See [“Replacement Parts” on page 35.](#) for part numbers of accessories.

DB-15 Power/Alarm Cables — Connects the Antenna Monitor to a power supply and to external controllers. 50 feet long with male/female connectors.

Note: Refer to [Figure 4](#) and [Figure 5 on page 11](#) for pin layout.

DB-15 Interface Connector — Allows easy custom data cable connections to the ACMI.

Rack Mount — The Rack Mount Kit allows one ACMI to be installed in a standard (2U) panel mount. The ACMI is secured with locator holes and a Velcro strap. Power is provided by a desk-top power supply, connected to a terminal strip at the factory. Available voltages are 15, 24, and 48 VDC. [Figure 2](#) lists dimensions and highlights important components.

Component Description

Figure 1 Antenna & Cable Monitor Outline

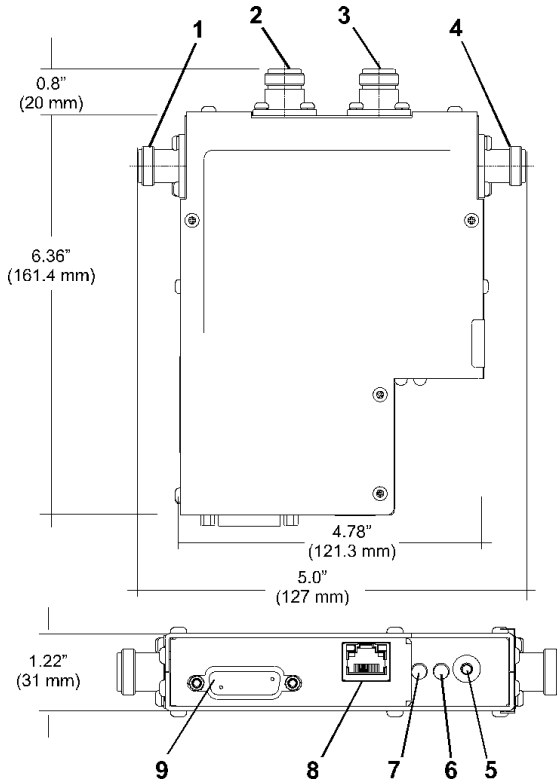

1	RF Input	Connects to the amplifier or combiner
2	Forward Monitor Port	Samples the forward traveling wave
3	Reflected Monitor Port	Samples the reflected wave
4	RF Output	Connects to the antenna or feeder
5	Reset Switch	Resets the alarm. If an alarm trigger is still present, the alarm will reactivate
6	Operation/Test LED	Green LED indicates when the unit is powered
7	Alarm LED	Red LED indicates when an alarm is triggered
8	Ethernet Port	RJ-45 connector. Interface to a PC using a Cat5 Ethernet cable
9	Power/Alarm Parallel Port	15 pin female connector. Connects to the power supply using a male 15 pin cable. Also used for remote operation.

Figure 2 Rack Mount Outline

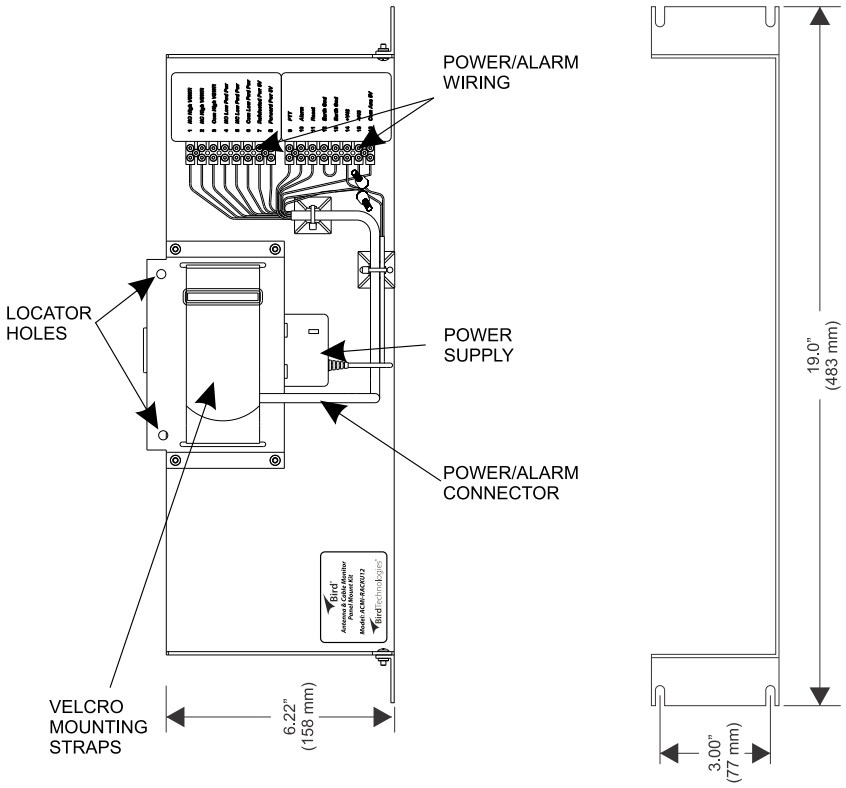

Alarm Response

When an alarm is triggered, the Bird Antenna & Cable Monitor turns on the alarm LED and de-asserts a TTL logic line (pulls low). In addition, depending on configuration settings, one Form C dry contact relay changes state (i.e. activates or de-activates) as a result of the VSWR alarm activating. A second Form C dry contact relay changes state as a result of either the low power or high power alarms activating. Refer to the Power/Alarm Connector pins for proper connection and Alarm configuration for set-up, see "[Power/Alarm Connector](#)" on page 10.

The LED activates and TTL logic line de-asserts as a result of any of the three alarm conditions (VSWR, low or high power).

If power to the unit is lost, both relays default to their de-energized condition. The Web Tool can configure whether the relays energize or de-energize during initialization or in response to an alarm when the unit is operating. Refer to the section on Alarms for instructions on setting alarm response behavior, see "[Alarm Tab](#)" on page 24.

Alarm Reset

- Alarms can be reset locally with the reset switch.
- Alarms are reset when the reset pin on the Power/Alarm port is activated by a TTL compatible logic low signal (0 to 0.8 VDC).
- The Web UI can reset the unit through the Ethernet port by sending a "Reset Alarm" command.
- Reset events clear all three alarms (VSWR, High Power, Low Power) and reset both relays.

Alarm Latching

The alarm defaults to latching operation. In this mode, the alarm will stay active until reset. In non-latching mode, the VSWR alarm will reset automatically about forty seconds after the trigger condition is corrected, power alarms will reset in about one-and-half seconds after the power condition is corrected.

VSWR Alarm

The ACMI continuously monitors forward and reflected power. From the power measurements, the VSWR is calculated and compared to the allowed maximum (default of 1.5 to 1). Based on the results of the comparison, possible actions include:

- No alarm is activated if the VSWR is less than the maximum, or if the VSWR alarm is disabled.
- If the VSWR is equal to or slightly greater than the maximum, additional measurements are accumulated for up to 30 seconds to determine a trend before triggering the alarm. If the VSWR trend is greater than the maximum level, an alarm is triggered, otherwise, measurements continue until a trend is established. An alarm will be triggered if the VSWR exceeds the maximum for more than thirty seconds.
- If the VSWR is much greater than the maximum then an alarm condition is triggered immediately.

Alarm on Zero Power

When the forward power is very small (< 2.5% of full scale), the measured VSWR becomes large due to the noise floor of the sensor. Under these conditions, the VSWR level is meaningless. When the zero power alarm is disabled, the VSWR will not be monitored at these low powers.

High Power Alarm

When the high power alarm is enabled, the forward power is continuously monitored. The alarm trigger is a percentage of the Monitor's full scale power, from 0 – 125%. If the forward power is greater than the trigger level, an alarm is triggered.

Low Power Alarm

When the low power alarm is enabled, the forward power is continuously monitored. The alarm trigger is a percentage of the Monitor's full scale power, from 0 – 125%. If the forward power is less than the trigger level, an alarm is triggered.

Push-to-Talk

The low power alarm and the VSWR alarm can falsely trigger when the transmitter is not keyed. The Push-to-Talk feature disables alarm checking for a predetermined period after the Push-to-Talk logic line is asserted. In order to prevent false alarms while monitoring for low power and high VSWR, the Push-to-Talk feature must be enabled.

This chapter provides information for preparing the Bird Antenna & Cable Monitor for use.

Unpacking and Inspection

1. Carefully inspect the shipping container for signs of damage.

Note: *If damage is noticed, do not unpack the unit. Immediately notify the shipping carrier and Bird Electronic Corporation.*

2. If the shipping container is not damaged, unpack the unit.

Note: *Save the packing material in case the unit needs to be shipped again.*

3. Inspect all of the components for visible signs of damage.

Note: *Immediately notify the shipping carrier and Bird Electronic Corporation of equipment damage or missing parts.*

The Bird ACMI is shipped complete and ready for use upon receipt. After unpacking and inspecting the unit, it is ready to be installed.

WARNING

Leaking RF energy is a potential health hazard. Never attempt to connect or disconnect equipment from the transmission line while RF power is being applied. Severe burns, electrical shock, or death can occur.

Mounting

Mount the ACMI in the feeder line between the combiner and the antenna. Make sure that the alarm LED and reset button are accessible, and that the connecting cables have proper clearance.

Cable Connections

Note: *Refer to [Figure 3 on page 9](#) for cable connections.*

When connecting the Bird ACMI to RF power, use 50 ohm coaxial cable suitable for the frequency and power level of operation. The cable connector should mate with the connector on the unit.

Connect the amplifier or combiner to the Monitor's input. Connect the antenna or feeder to the output.

WARNING

Do not touch the center conductor of the power monitor ports while RF power is being applied.

To monitor the RF waveform, connect the forward and reflected power monitor ports to an appropriate power sensor or meter.

Note: If a power monitor port is not being used, terminate it with a 50Ω load.

Figure 3 Cable Connections

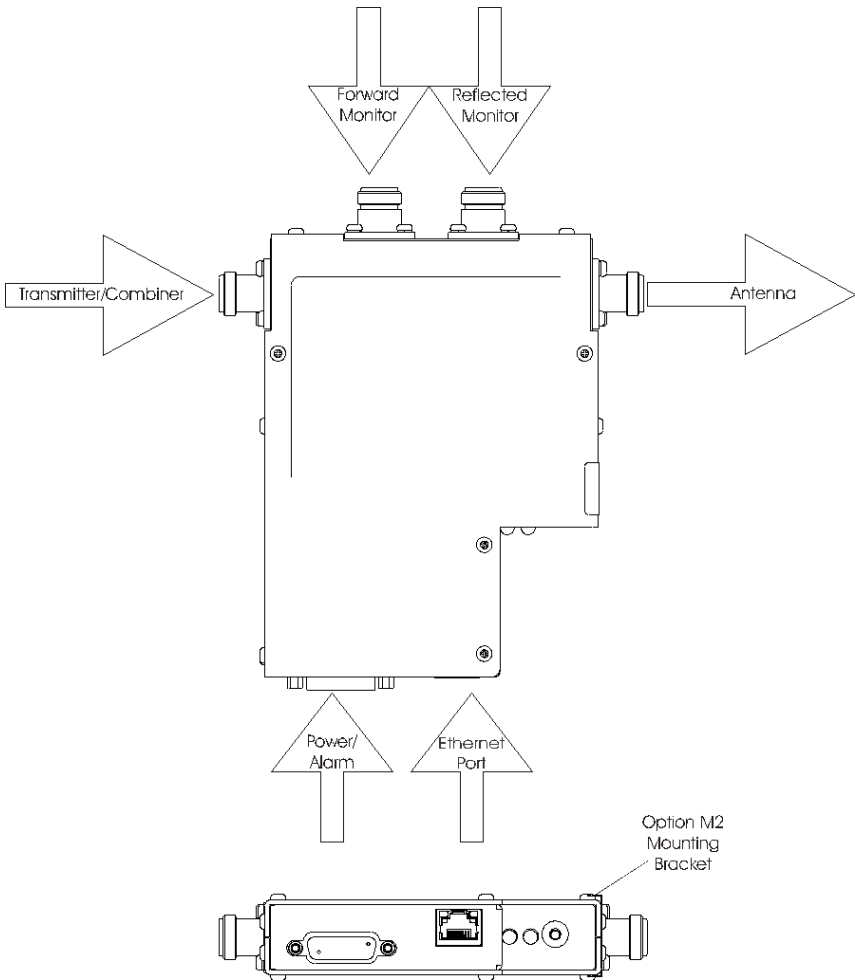

Power/Alarm Connector

Note: The power cable must be <50m in length.

Connect the external power supply here. Pin numbers and descriptions are given in [Figure 4](#).

If installing the ACMI in a Rack Mount Kit, a power supply is provided with the kit.

CAUTION

The input voltage must be clean and stable. Ensure that the input voltage does not surge and does not contain spikes. Failure to comply may result in permanent damage to the instrument.

CAUTION

The maximum input voltage differential is 72 V for High Voltage models, 36 V for Medium Voltage models, and 18 V for Low Voltage Models. Do not apply an input voltage differential greater than the voltage limit for the model. Failure to comply may result in permanent damage to the instrument.

High voltage models (ACMI-x-xxxxxH and ACMI500-x-xxxxxH) require 36 to 72 VDC (48 V nominal). Either terminal (10 or 11) may be connected to DC input ground, as dictated by the power supply requirements.

Medium voltage models (ACMI-x-xxxxxM and ACMI500-x-xxxxxM) require 18 to 36 VDC (24V nominal). Either terminal (10 or 11) may be connected to DC input ground, as dictated by the power supply requirements.

Low voltage models (ACMI-x-xxxxxL and ACMI500-x-xxxxxL) require 9 to 18 VDC (12 V nominal). Either terminal (10 or 11) may be connected to DC input ground, as dictated by the power supply requirements.

Figure 4 Voltage DB-15 Power/Alarm Connector, Female

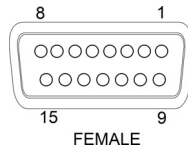

Pin	Description
1	Relay 1, VSWR alarm contact, normally closed (closed when relay is not energized or loss of power to unit) (open when the relay is engaged)
2	Relay 1, VSWR alarm common contact
3	Alarm output, TTL compatible TTL High (≥ 4.3 VDC with a 10k load) = no alarm TTL Low (<0.2 VDC) = alarm (VSWR, Low, or High Power)
4	PTT input, +5V to +24V to activate, 0V or open to deactivate
5	Reset input, TTL compatible TTL Low (<0.5 VDC) resets all active alarms
6	Relay 2, Power Alarm contact, normally closed (closed when relay is not energized or loss of power to unit) (open when relay is energized)
7	Relay 2, Power Alarm common contact
8	Relay 2, Power Alarm contact, normally open (open when relay is not energized or loss of power to unit) (closed when the relay is energized)
9	Relay 1, VSWR Alarm contact, normally open (open when relay is not energized or loss of power to unit) (closed when the relay is energized)
10	DC input, + terminal. See Figure 5 .
11	DC input, - terminal. See Figure 5 .
12	Analog FWD, 0 to 5 VDC linearly proportional to forward power, 200 ohm output impedance
13	Analog RFL, 0 to 5 VDC linearly proportional to reflected power, 200 ohm output impedance
14 - 15	Ground

Figure 5 Power/Alarm Connector Wiring, Female

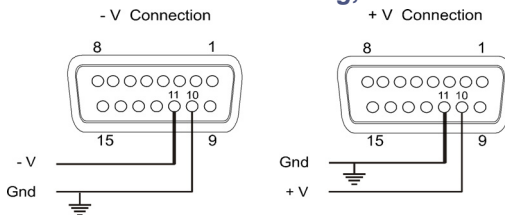

Panel Mount

WARNING

Disconnect the unit from the RF power source and the AC line before any disassembly. The potential for electrical shock exists.

CAUTION

The +15V supply should only be used to power the ACMI Panel. Do not connect anything else to the power supply.

Installation

To install a Bird Antenna Monitor in the rack mount, follow these instructions (Refer to [Figure 2 on page 4](#)):

1. Unbuckle the Velcro strap and move the power/alarm connector out of the way.
2. Place the ACMI on the panel so that the screws on the bottom of the Monitor fit into the locator holes on the panel.

Note: *The ACMI should lock into place.*

3. Use the strap to secure the ACMI.
4. Plug the power/alarm connector into the power/alarm parallel port on the ACMI.
5. Make RF and Ethernet connections as described in this chapter.

Ethernet Connector

Note: *Max. Ethernet cable length must be <50m.*

The Ethernet connector carries data between the Antenna Monitor and a PC.

When connecting to the ACMI using the Ethernet port, you use the Web Tool software to setup the ACMI. You do not need to install the Web Tool software because it is part of the ACMI firmware.

In order to determine the IP address of the ACMI, the ACMI Finder utility will need to be installed.

Note: *You must have Java runtime environment version 7 (JRE v7) or higher installed before you can use the Web Tool or Finder software.*

CAUTION

Network connections require specific address and protocol information. Have a qualified IT or network professional perform the ACMI Ethernet setup. Failure to comply may result in loss of network communication or the inability to communicate with the ACMI.

The setup in this section should be performed only by a person who thoroughly understands IP and network setup protocols.

Note: *If you are connecting to a network, before you begin, do the following:*

- Contact your IT professional to get the subnet mask values for your network and to determine whether or not your network has a DHCP server.
- Inform your network administrator that the ACMI will use port 10001. The network administrator might need to open this port before you can set up the ACMI.

1. Install the Java runtime environment.

Note: *Perform this step if it is not already done.*

Note: *To use the Web Tool software, your PC must have a compatible web browser and the Java runtime environment version 7 (JRE v7) or higher installed prior to connecting the ACMI to an Ethernet device. If you do not have the runtime environment, you can download it from the web at www.java.com or from the Bird Technology web site (www.birdrf.com).*

Note: *It may be necessary to change the Java runtime environment security level in order for the Web Tool to operate. This can be accomplished by opening your Control Panel and double clicking the Java control panel icon. In the Security tab, reduce the security level to its lowest setting. Contact your IT professional for more information.*

WARNING

Dangerous RF voltage. Do not connect or apply an RF signal to the ACMI during equipment setup. Failure to comply may result in severe burns, loss of use of limbs, or death.

WARNING

Do not connect RF power to the unit.

2. Apply operating power to the ACMI.
3. Follow the Ethernet setup flowchart ([Figure 6](#)) to complete the installation.

Figure 6 Ethernet Connection Flowchart

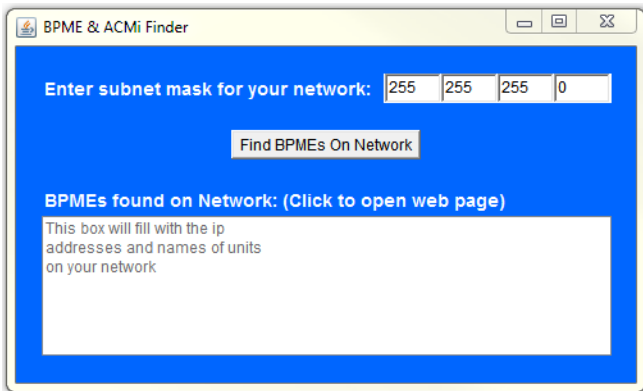
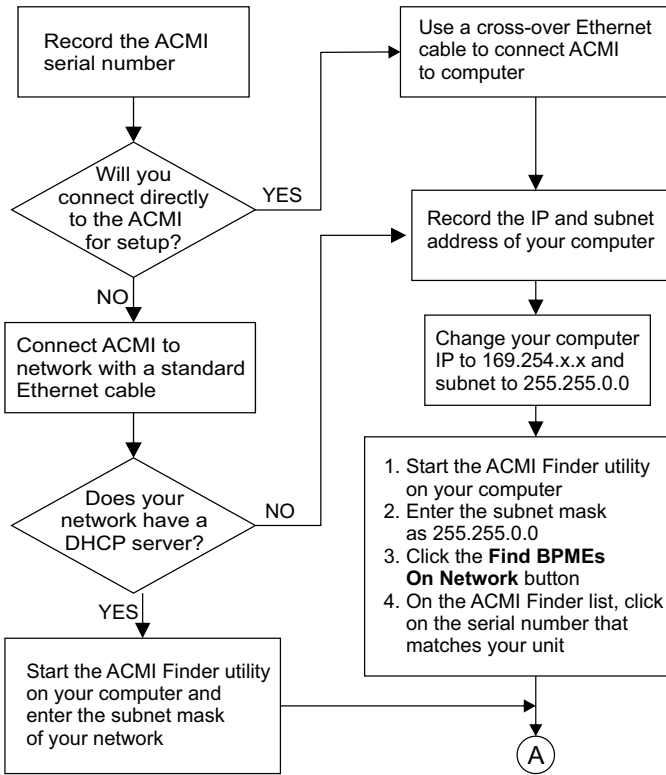

A

When you click on the serial number that matches your unit, the Web Tool starts. If Web Tool doesn't start, your web browser is not in your path. Either add it to your path or open your Web browser and enter the IP address of the ACMI in the address bar. `http://<ip address>`

B

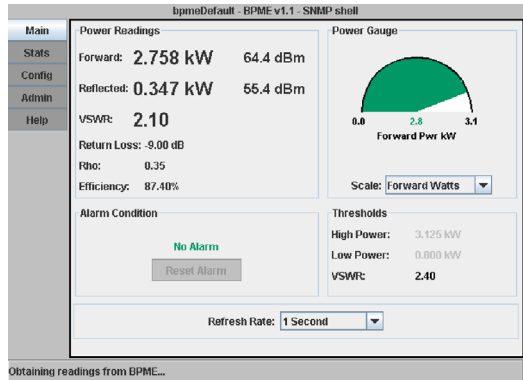

B

In the Admin Screen, Networking tab you can specify the following information about the address of the ACMI: IP address, subnet mask, gateway IP, DHCP host name, and whether or not DHCP is used. Contact your IT professional for assistance in determining the IP address, subnet mask, and information about DHCP use and name.

C

The screenshot shows the 'bpmeDefault - BPME v1.1' Admin screen with the 'Email Alerts' tab selected. The left navigation menu is the same as in the previous screenshot. The main content area contains:

- Navigation tabs: Network, Email Alerts, SNMP, Passwords.
- Email Alerts Enabled
- SMTP Server IP: 10.128.0.241
- SMTP Port: 25
- Recipient 1: frank@mycompany.com
- Recipient 2: sue@mycompany.com
- Email From: bpmeDefault@bpme.com
- An 'Apply All Changes' button at the bottom.

 At the bottom of the screen, it says 'All settings retrieved.'.

Note: The name you enter (at the left of the @ symbol) is also used in the ACMI Finder utility. If you use the email option to notify someone that an alarm has occurred, the name of this ACMI will help identify where the alarm came from.

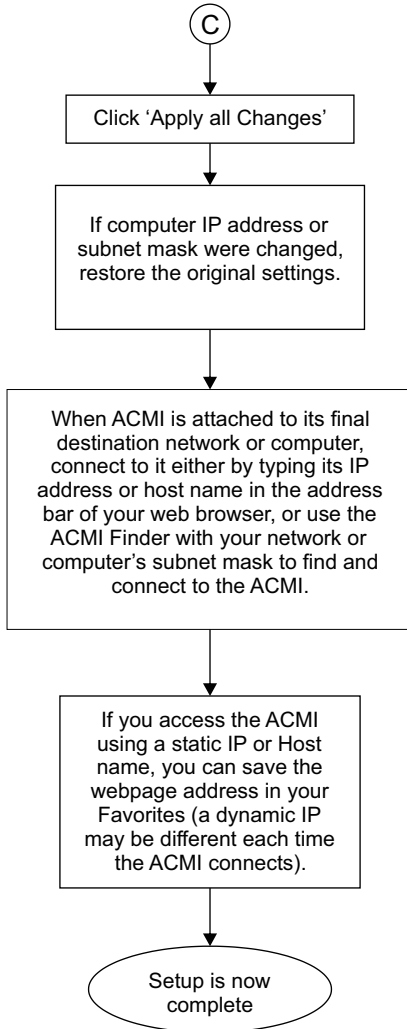

Note: To use the features of the Web Tool, refer to ["Operating Instructions" on page 19.](#)

Web Tool Software

Computer Requirements

The Web Tool software does not need to be installed because it is part of the ACMI firmware. The Web Tool will run on any computer with a supported web browser and Java runtime environment version 7 (JRE v7) or higher installed. In order to locate the IP address of an ACMI, the ACMI Finder Utility is used. This is a separate program that is installed on a host machine and is not part of the Web Tool software.

To run the program, your computer system must have appropriate system requirements to run a Web browser that supports Java runtime environment version 7 (JRE v7) or higher such as Microsoft® Internet Explorer or Google Chrome™ Browser

The ACMI Finder tool and JRE may be downloaded from the Bird Technologies Group website at:

<http://www.birdrf.com>

Web Tool Software

The ACMI Web Tool software is used to monitor the measurement outputs from the ACMI and to set and change alarm and network configurations. This software runs in a web browser (such as Microsoft's Internet Explorer). To use the tool, open a web browser then in the address field, type the IP address of the ACMI you wish to access. The software has five buttons at the left side that open the following screens: Main, Stats, Config, Admin, and Help.

Main Screen

The Main screen is the default screen you see when you open the Web Tool software ([Figure 7 on page 20](#)). The Main screen identifies the ACMI at the top of the window. The center of the screen displays measurement data that is being received from the ACMI. You can set the refresh rate from 1 second to 60 seconds (how frequently the software updates the data from the ACMI). At the bottom of the window, the status bar displays various information about the software and uses three alert colors, red - a fatal error (cannot establish connection, connection lost), yellow - a warning (cannot complete a user request, user does not have access permission), gray - normal operation.

The alarm condition area ([Figure 8 on page 20](#)) will display three conditions

- No alarm (green text) - no alarm condition exists
- Latched (red text) - an alarm condition did occur but its cause has been fixed or the cause no longer exists.
- Alarm (red text) - an alarm condition that has occurred and has not gone away or been reset is identified by text (VSWR, High Pwr, Low Pwr, or any combination of these if more than one alarm exists).

You can reset the alarm at the ACMI by pressing the reset button or by clicking on the Reset Alarm button on the Web Tool Main screen. If the cause of the alarm is still present, the message cannot be reset.

Figure 7 ACMI Web Tool Software, Main Screen

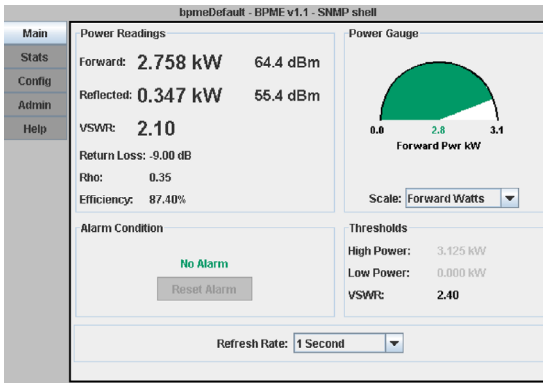
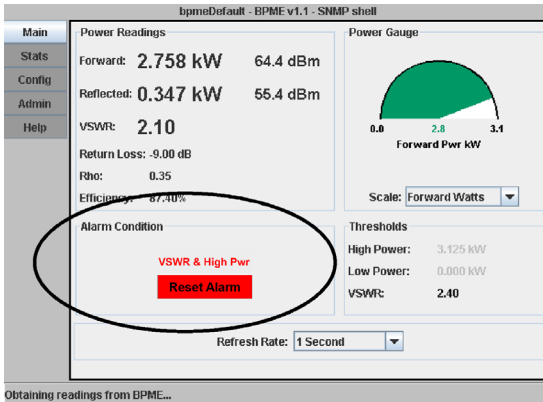

Figure 8 Alarm Active Message



Stats Screen

The Stats screen (Figure 13 on page 24) can chart and display historical data stored in the ACMI memory. You can chart forward and reflected power readings and alarm conditions (low power, high power, and VSWR alarm). You can display the data in either a line graph or a bar chart.

The ACMI keeps data for a 365 day period. You select the starting day (in the Begin field) and the number of days to view. Day 0 is today, day 1 is yesterday, and so on to day 364. Click the Add >> button to add the days to the list to view.

When you click the Chart It button, the Web Tool retrieves the data and generates a new chart. Click the Clear button to clear your day selection.

The Stats View is not password protected. It is used to retrieve and plot historical data stored on the ACMI. You can use the controls provided on this view to generate charts and save the data for your records.

Data Log

The ACMI maintains a 365 day log (data log) of forward and reflected power readings and alarm conditions (low power, high power, and VSWR alarm). For each new day, the ACMI will automatically take a power reading every minute and average it with the previous minute. This averaged value is temporarily stored every hour and then a new average is started. If an alarm occurred over the course of an hour, then a value of '1' is logged for the specific condition that triggered the alarm: low power, high power, and/or VSWR. At the end of a 24 hour period, the hourly power reading data is averaged and the percentage of time that a specific alarm was on is written to non-volatile storage. Each individual hour's data (both powers and alarms) is also written to non-volatile storage at the end of the day. If the power is lost, you will lose only historical data obtained for the current day after the log started and before the power went out. All other data will remain intact.

Figure 9 Data Log

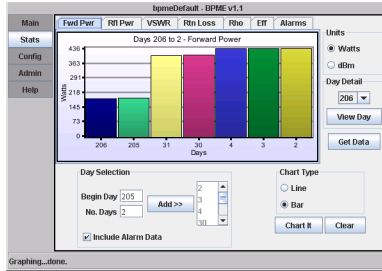

Day Selection

The steps to create and display information from the data log are: select the days to view, choose to include or exclude alarm data, select chart type, chart the data.

1. Select Days
 - a. Decide which days to view.

Note: *Day 0 is today, day 1 is yesterday, and so on up to day 364.*
 - b. Enter the day number of the log you wish to view in the **Begin** field under **Day Selection**.
 - c. Click the **Add >>** button to add it to the list of days to view.
- To add a range of days,
 - a. Enter the start day in **Begin**.
 - b. Enter the number of days in the **No. Days** field.
 - c. Click the **Add >>** button.

Note: *The day numbers can be added in any order and any range.*

Example - Comparing data from days 3-6 to days 203-206 on the same chart. You can view the days you've selected by scrolling the list to the right of the **Add >>** button under **Day Selection**.

Note: The more days you view, the longer it will take to chart them.

2. Include Alarm Data

- a. Check the **Include Alarm Data** check box.

Note: This will retrieve alarm data for each selected day and generate a new alarm chart. The chart will be shown under the "Alarms" tab. See the figure below for an example of an alarms bar chart.

3. Choose Chart Type

- a. Select the chart type: **Line** or **Bar**.

Note: A line chart will plot the data as a simple connected line graph with data values on the y-axis and the time units (days or hours) on the x-axis. The line chart has no day limit and can also be used to plot hourly data.

Note: A bar chart will plot the data as vertical bars - one for each day - with the days on the x-axis and the data values on the y-axis. You can use the bar chart to plot up to only 12 days at once.

Note: Hourly data is logged with hour 0 as the first hour of the day and hour 23 as the last hour of the day.

4. Chart the Selection

- a. Click the **Chart It** button to retrieve the data and generate a new chart.
- b. Click **Clear** to clear your day selections.

Note: Once the chart has been displayed you can browse the various graphs for each power scale and alarms by clicking on the appropriate tab at the top of the chart. Each chart is plotted in a similar fashion - from the least-recent to the most-recent data value acquired - when reading from left to right along the x-axis.

Figure 10 Alarms Screen

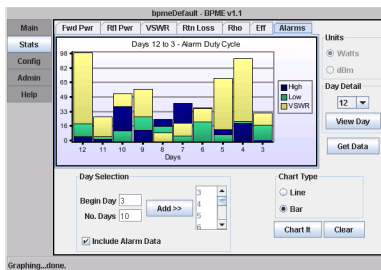

Get Data

1. Click the **Get Data** button.

Note: This will display the data for the current chart in a new window in a tab-delimited text format.

2. Copy the text and paste it into a file on your computer or directly into a Microsoft Excel workbook.

Note: In MS Windows, hold the Ctrl button and press A to select all the data, hold Ctrl and press C to copy, select your destination (e.g. Excel), and hold Ctrl and press V to paste. See the figure below for an example.

Figure 11 Get Data Screen

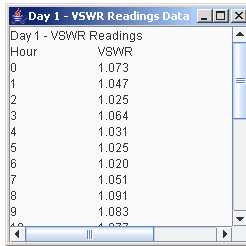

Day Detail

1. Select a day under **Day Detail** (at the right of the chart).
2. Click the **View Day** button to retrieve and generate a new chart of hourly data for the selected day.

Note: This new chart will appear in a new window. The window can be resized to stretch the chart's dimensions (by dragging the lower-right corner of the window).

3. Click the **Get Data** button on this window to display the hourly data for the selected day in a new window.

Note: It works just like the **Get Data** button explained in the above paragraph.

Figure 12 Day Detail

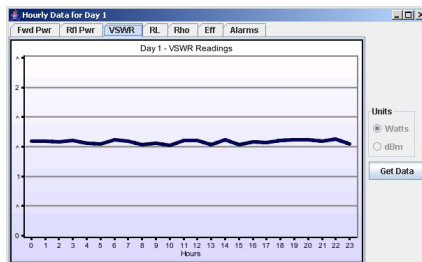
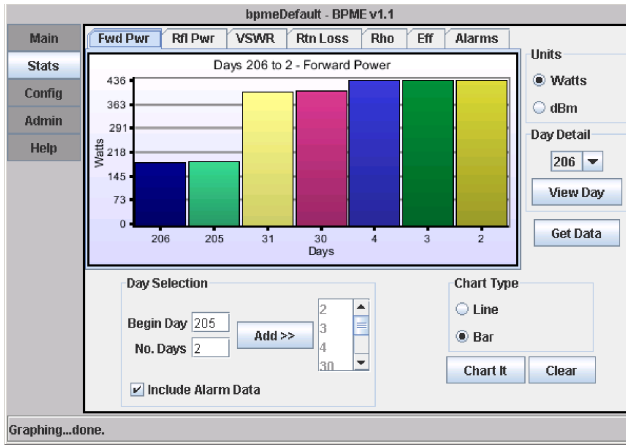

Figure 13 Web Tool Stats Screen



Config Screen

The Config (Configure) screen sets alarm configuration and analog output gain. The administrator of the Web Tool can set an optional password requirement to control who can make changes to the Config screen. The Config password is disabled by default. Refer to Admin Screen for password control.

Alarm Tab

In the Alarms tab ([Figure 14 on page 26](#)), you specify ACMI alarm settings. To return to the factory default alarm settings, click on the Factory Default button. After you have set the alarm preferences, click the Apply Changes button to record your settings in memory.

You can select or deselect the following alarm conditions:

Latch Alarms — Sets whether the alarm will reset automatically in the absence of an alarm condition. When this checkbox is unchecked, if an alarm trigger is corrected, the VSWR alarm will reset after a forty-five second delay and the power alarms after a one and a half second delay. When the box is checked, the alarms must be manually reset.

Alarm at Power (Pwr) Up — At power up, before the instrument is ready to take measurements, the unit performs initialization tasks. During this period, the unit's alarm indicators (LED & TTL output) will activate for ~2ms and the alarm relays will toggle to the alarm-active state for ~2ms (i.e. change from activated to deactivated or visa-versa depending on the Relay Energized on Alarm configuration).

Checking the Alarm at Pwr Up box will cause the unit's alarm indicators and alarm relays to remain in an alarm condition from the time power is applied until the unit begins making measurements. At that time, the relays and indicators will return to their no-alarm condition until an event activates them.

VSWR Alarm Enable — Check the VSWR Alarm Enable box to monitor the VSWR reading and activate the alarm if the VSWR is slightly greater than the trip point for more than 30 seconds, or immediately if the VSWR is much greater than the Trip Point.

VSWR Relay Energized on Alarm — Checking this box will cause the VSWR alarm relay to energize if the VSWR alarm is active and de-energize when the alarm is not active. Unchecking this box will cause the VSWR alarm relay to de-energize when the alarm is active and energize when it is not active. Unchecking this box ensures a fail-safe alarm configuration in the event of loss of power to the ACMI.

This setting will determine which relay contact will be open and which will be closed in the event of an alarm condition and influence the hard-wiring of the VSWR relay contacts. Refer to the power/alarm connection instructions.

VSWR trip point — Specify the VSWR value that will cause a VSWR alarm (select values from the drop-down list). This value is adjustable from 1.3 to 2.5 by increments of 0.1. Check the VSWR Alarm Enabled on Zero Power checkbox to allow the VSWR alarm to trigger at very low forward power (< 2.5% of full scale power).

High Power Alarm (forward power only) — Check the Enable box and specify the percentage of full scale at which an alarm will occur. The high power value must be greater than the low power value. The maximum value is 125% of full scale power. The alarm setpoint is entered as a percent of full scale. For example, if you have a 500W full scale unit and would like an alarm when the forward power exceeds 375 W, the alarm setpoint would be $375/500 \times 100$ or 75%. Enter 75 in the field and check the Enable High Power Alarm checkbox.

Low Power Alarm (forward power only) — Check the Enable box and specify the percentage of full scale at which an alarm will occur. The low power value must be less than the high power value. The minimum is 0%.

Power Relay Energized on Alarm — Checking this box will cause the Power alarm relay to energize if the Power alarm is active and de-energize when the alarm is not active. Unchecking this box will cause the Power alarm relay to de-energize when the alarm is active and energize when it is not active. Unchecking this box ensures a fail-safe alarm configuration in the event of loss of power to the ACMI.

This setting will determine which relay contact will be open and which will be closed in the event of an alarm condition and influence the hard-wiring of the Power relay contacts. Refer to the power/alarm connection instructions.

Trigger Alarm Button — Use the Trigger Alarm button to force an alarm on the ACMI. You can use this function to test the response of your system to alarm indicators (messages, relay, TTL outputs). If the Config password is enabled, you will be required to enter the password before you can test the alarm settings.

Factory Defaults — Use the Factory Defaults button to return the ACMI configuration to factory default conditions (Latch Alarms and VSWR Alarm Enable checked, VSWR Trip Point =1.8, power alarms, and PTT disabled).

Figure 14 Web Tool Config Screen, Alarms

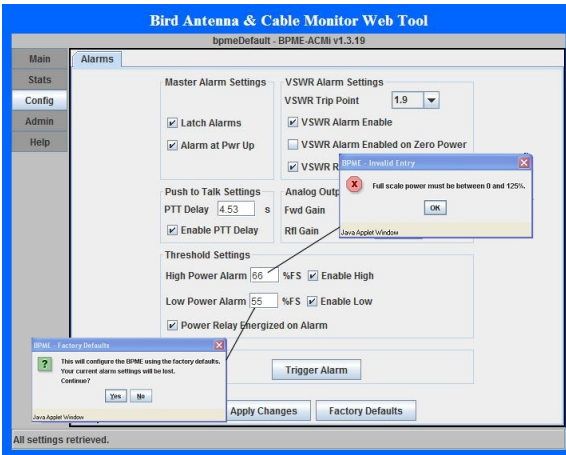

Admin Screen

The Admin screen has four tabs, Network, Email Alerts, SNMP, and Passwords. After making changes in one or all of the tabs, click the Apply All Changes button to record your settings in memory.

You must have a password to view and edit the Admin screen. The Admin password is left blank by default. The administrator of the Web Tool can change the password to control who can make changes to the Admin screen. Refer to Password Tab for password control.

Note: The Admin password is left blank (null) by default

Network Tab

In the Networking tab ([Figure 15 on page 27](#)), you can specify the following information about the address of the ACMI: IP address, subnet mask, gateway IP, DHCP host name, and whether or not DHCP is used.

An IP address is required even if you connect the ACMI directly to a computer that is not on a network. Contact your IT professional for assistance in determining the IP address, subnet mask, and information about DHCP use and name.

Figure 15 Web Tool Admin Screen, Network Setup

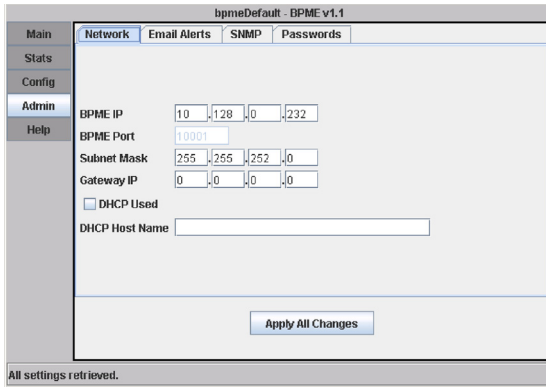

Email Alerts Tab

In the Email Alerts tab (Figure 16 on page 27), you can specify the following information: the SMTP server IP, the SMTP port, whether or not to use the email alerts, the email address of the ACMI, and the email addresses of two people to notify when an alarm occurs (optional).

You can have the Web Tool software contact two specified recipients via email if an alarm occurs. The ACMI needs to be connected to a computer or server that has email capabilities. Contact your IT professional for assistance in determining the SMTP server IP and port. The text you enter at the left of the @ symbol in the From email address will uniquely identify this ACMI in all sent emails. Use text that will identify the ACMI and its location. The text at the right of the @ symbol is the email domain information for your server.

Figure 16 Web Tool Admin Screen, Email Alerts

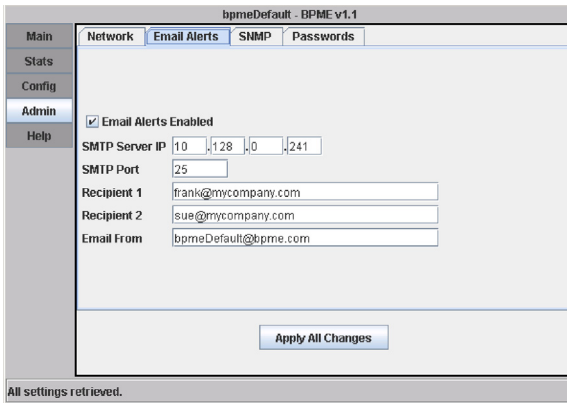

SNMP Tab

In the SNMP tab (Figure 17 on page 28), you can specify setup for the SNMP feature if you have chosen to use it. Contact your IT professional for assistance. You can obtain the latest MIB file from the Bird Technologies web site.

Figure 17 Web Tool Admin Screen, Set SNMP Email Address

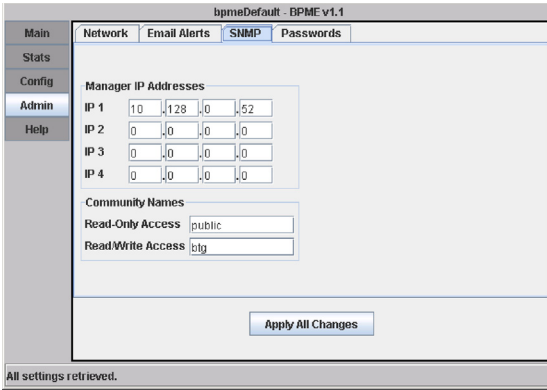

Password Tab

In the Password tab (Figure 18 on page 28), you can set the administrator password and the optional configuration access password. When you set or change a password, you must type the password a second time in the appropriate “confirm” field before it will be accepted.

You must have a password to view and edit the Admin screen. The default password is left blank. After you make changes, click on the Apply All button.

If a configuration access password is set, users can view the Config screen but not edit it. A password must have at least 3 and no more than 49 characters.

Figure 18 Web Tool Admin Screen, Passwords

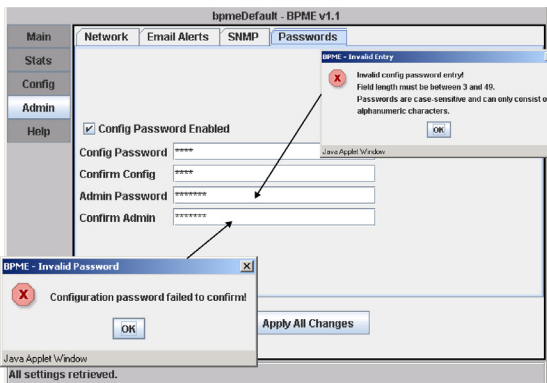

Help Screen

While you are using the Web Tool software, you can access an on-line version of this manual by clicking on the Help button at the left side of the screen.

Push-to-Talk

When enabled, the Push-to-Talk (PTT) feature monitors the PTT logic input on the DB-15 connector. When the PPT input is not asserted (low or open), the low-power and VSWR alarms will not be monitored. When the PTT logic input is asserted (i.e. when the transmitter is keyed) the PTT delay timer will begin to countdown. During this PTT Delay, the low-power and VSWR alarms will continue not to be monitored. The alarms will be monitored only when the end of the PPT Delay is reached and the PTT logic input is still asserted. This prevents false alarms while monitoring for low power and high VSWR.

Note: *The VSWR Alarm Enable and/or Low Power Alarm Enable must be enabled (checked) in order for these alarms to activate after a PTT logic event and delay.*

Setting Push-to-Talk

1. Open the Power Monitor Options dialog.
2. Do one of the following:
 - Check the Enable checkbox to turn the Push-to-Talk feature on.
 - Uncheck the Enable checkbox to turn the Push-to-Talk feature off.
3. Enter any value for the time up to 14 sec.

Note: *The time actually programmed on the ACMI will be a multiple of 156.25 ms. For this reason, the time displayed will be slightly different from the time set. The actual delay from the PTT signal is uncertain because the PTT signal is asynchronous to the internal measurement samples. The uncertainty is +/- 156.25 ms.*

Figure 19 Push-to-Talk

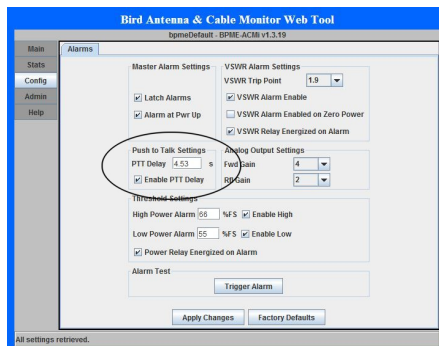

Analog Output Gain

This setting controls the sensitivity of the two analog outputs on the ACMI. The output level for the two channels are proportional to the measured power in the forward and reflected directions. The output range is 0 to 5.0 V with 10 bits of resolution. The gain settings allow the adjustment of the range at the cost of resolution.

Example - At a gain of 1, the resolution is approximately 0.12% of full scale. At a gain of 8 it is approx 0.015% of full scale.

The tables below show the forward and reflected range and resolution for the 100 W and 500 W ACMIs for the various gain settings:

Table 1 100 W ACMI

Gain	Max (W)	Resolution (mW)	Max (W)	Resolution (mW)
1	125.00	122.0703	12.50	12.2070
2	62.50	61.0352	6.25	6.1035
4	31.25	30.5176	3.13	3.0518
8	15.63	15.2588	1.56	1.5259

Table 2 500 W ACMI

Gain	Max (W)	Resolution (mW)	Max (W)	Resolution (mW)
1	625.00	610.3516	62.50	61.0352
2	312.50	305.1758	31.25	30.5176
4	156.25	152.5879	15.63	15.2588
8	78.13	76.2939	7.81	7.6294

This chapter contains troubleshooting instructions, part information, and specifications for the Bird Antenna & Cable Monitor.

Inspection and Cleaning

This unit requires only simple and routine maintenance.

CAUTION

Do not use harsh or abrasive detergents for cleaning.

WARNING

Disconnect the unit from the RF power source and the AC line before any disassembly. The potential for electrical shock exists.

1. Wipe off dust and dirt regularly.

Note: *Use a soft, clean cloth dampened with mild detergent.*

2. Check connectors, connector pins, and cables for damage.

Note: *If needed, clean the connectors using a self-drying contact cleaner that leaves no residue.*

Troubleshooting

The Bird Antenna Monitor has no operator serviceable parts. Any required service must be performed at an authorized service facility.

The table below contains troubleshooting information for problems which can occur during normal operation. This manual cannot list all malfunctions that may occur, or their corrective actions. If a problem is not listed or is not corrected by the listed actions, notify a qualified service center.

Problem	Possible Cause	Correction
Operation/Test LED does not illuminate	No DC power	Check power source.
	Defective LED	Return the unit to an authorized service center.
Alarm LED does not illuminate	Defective LED	Return the unit to an authorized service center.
High VSWR	Dirty connectors	Clean connectors.
	Defective connectors	Return the unit to an authorized service center.
	Shorted or open transmission line	Have the line serviced.

Customer Service

Any maintenance or service procedure beyond the scope of those in this chapter should be referred to a qualified service center.

If the unit needs to be returned for any reason, request an Return Material Authorization (RMA) through the Bird Technologies website. All instruments returned must be shipped prepaid and to the attention of the RMA number.

Bird Service Center

30303 Aurora Road
 Cleveland (Solon), Ohio 44139-2794
 Fax: (440) 248-5426
 E-mail: bsc@birdrf.com

For the location of the Sales Office nearest you, visit our Web site at:

<http://www.birdrf.com>

Specifications

General

Directivity, Min. 108 – 960 MHz 960 – 2400 MHz	30 dB 26 dB
VSWR Alarm Setpoint	1.3:1.0 to 2.5:1.0 by 0.1:1.0 steps. Refer to "Power/Alarm Connector" on page 10 for information about power limitations.
Alarm Relays	Dry, form C. Common, normally open, & normally closed contacts.
Relay Contact Rating	100 VDC @ 0.5 A
Visual Alarm	Red LED will light to indicate an alarm
Alarm Stimulus	VSWR setpoint exceeded, response time proportional to overload
Alarm Reset	Local mechanical reset switch Remote input (Reset if VDC = 0 to +0.8 V)
RF Connectors	Male or Female, N or 7/16 DIN
Monitor Port Connectors	Female N, TNC, or BNC
Monitor Port Coupling	-63 dB nominal
Passive Intermodulation Products	< -130 dBc
Ethernet Port Connector Protocol	RJ-45 10/100 IEEE802.3
Power/Alarm Parallel Port	Female DB-15 connector
Power Requirements ACMI-x-xxxxxL ACMI500-x-xxxxxL ACMI-x-xxxxxM ACMI500-x-xxxxxM ACMI-x-xxxxxH ACMI500-x-xxxxxH	+/- (8 to 18) VDC @ 2.65 W +/- (8 to 18) VDC @ 2.65 W +/- (18 to 36) VDC @ 2.65 W +/- (18 to 36) VDC @ 2.65 W +/- (36 to 72) VDC @ 2.65 W +/- (36 to 72) VDC @ 2.65 W
Analog Outputs	0 to 5 V full scale, 200 ohm output impedance
Temperature Operating Storage	0 to 50 °C (32 to 122 °F) -20 to +80 °C (-4 to +176 °F)
Altitude, Max.	3000 m (10,000 ft.)
Humidity, Max.	95% non-condensing
Dimensions, Nominal, without connectors	4.75" L x 6.44" W x 1.22" H (121 x 164 x 31 mm)

Weight, Max.	2 lbs. (0.9 kg)
--------------	-----------------

Frequency Range

ACMI500	ACMI	
---	L0-xxxxxx	108 – 144 MHz
L1	L1-xxxxxx	136 – 225 MHz
L2	L2-xxxxxx	225 – 520 MHz
M	M-xxxxxx	470 – 960 MHz
---	H-xxxxxx	960 – 2400 MHz

RF Power Range

ACMI-xx-xxxxxx	2.5 – 100 W
ACMI500-xx-xxxxxx	12.5 – 500 W

Accuracy

ACMI500	ACMI	
---	L0	+/- 8%
L1	L1	± 10%
L2	L2	± 8%
M	M	± 5%
----	H	± 5%

Insertion Loss, Max.

108 - 960 MHz	0.1 dB
960 - 2400 MHz	0.15 dB

VSWR, Max.

N Connectors	
108 - 960 MHz	1.07:1
960 - 2400 MHz	1.1:1

7/16 DIN Connectors	
108 - 960 MHz	1.07:1
960 - 2000 MHz	1.1:1
2000 - 2400 MHz	1.2:1

Safety

EMC	<p>Directive 2004/108/EC relating to electromagnetic compatibility</p> <p>EN 61326-1 - Electrical equipment for measurement, control and laboratory use - EMC requirements - Part 1: General requirements (IEC 61326-1):</p> <p>Radiated Immunity (EN 61000-4-3)</p> <p>Radiated Emissions (EN 55011)</p> <p>ESD Immunity (EN 61000-4-2)</p> <p>EFT Immunity (EN 61000-4-4)</p> <p>Surge Immunity (EN 61000-4-5)</p> <p>Conducted Immunity (EN 61000-4-6)</p>
Safety	<p>European Standard EN 61010-1:2001 – Safety Requirements for Electrical Equipment for Measurement, Control, and Laboratory Use.</p>

Replacement Parts

Description	Part Number
Instruction Manual	920-ACMI
DB-15 Interface Cable, 50 ft., male/female	5A2264-15-MF-50
DB-15 Interface Connector	SUBCON-15/M-SH
Rack Mount Kit with 15 VDC Power Supply with 24 VDC Power Supply with 48 VDC Power Supply	ACMI-RACKU15 ACMI-RACKU24 ACMI-RACKU48

Limited Warranty

All products manufactured by Seller are warranted to be free from defects in material and workmanship for a period of one (1) year, unless otherwise specified, from date of shipment and to conform to applicable specifications, drawings, blueprints and/or samples. Seller's sole obligation under these warranties shall be to issue credit, repair or replace any item or part thereof which is proved to be other than as warranted; no allowance shall be made for any labor charges of Buyer for replacement of parts, adjustment or repairs, or any other work, unless such charges are authorized in advance by Seller.

If Seller's products are claimed to be defective in material or workmanship or not to conform to specifications, drawings, blueprints and/or samples, Seller shall, upon prompt notice thereof, either examine the products where they are located or issue shipping instructions for return to Seller (transportation-charges prepaid by Buyer). In the event any of our products are proved to be other than as warranted, transportation costs (cheapest way) to and from Seller's plant, will be borne by Seller and reimbursement or credit will be made for amounts so expended by Buyer. Every such claim for breach of these warranties shall be deemed to be waived by Buyer unless made in writing within ten (10) days from the date of discovery of the defect.

The above warranties shall not extend to any products or parts thereof which have been subjected to any misuse or neglect, damaged by accident, rendered defective by reason of improper installation or by the performance of repairs or alterations outside of our plant, and shall not apply to any goods or parts thereof furnished by Buyer or acquired from others at Buyer's request and/or to Buyer's specifications. Routine (regularly required) calibration is not covered under this limited warranty. In addition, Seller's warranties do not extend to the failure of tubes, transistors, fuses and batteries, or to other equipment and parts manufactured by others except to the extent of the original manufacturer's warranty to Seller.

The obligations under the foregoing warranties are limited to the precise terms thereof. These warranties provide exclusive remedies, expressly in lieu of all other remedies including claims for special or consequential damages. SELLER NEITHER MAKES NOR ASSUMES ANY OTHER WARRANTY WHATSOEVER, WHETHER EXPRESS, STATUTORY, OR IMPLIED, INCLUDING WARRANTIES OF MERCHANTABILITY AND FITNESS, AND NO PERSON IS AUTHORIZED TO ASSUME FOR SELLER ANY OBLIGATION OR LIABILITY NOT STRICTLY IN ACCORDANCE WITH THE FOREGOING.

