

I N S T R U C T I O N B O O K

F O R

M O D E L 8 5 7 2 / 7 3

T E R M A L I N E® L O A D R E S I S T O R

BIRD
Electronic Corporation

30303 Aurora Road, Cleveland, Ohio 44139-2794

Copyright 1987 by Bird Electronic Corporation

SAFETY PRECAUTIONS

The following are general safety precautions that are not necessarily related to any specific part or procedure and do not necessarily appear elsewhere in this publication.

Keep away from live circuits.

Operating personnel must at all times observe normal safety regulations. Do not attempt to replace parts or disconnect a RF transmission or any other high voltage line while power is applied. When working with high voltage always have someone present who is capable of rendering aid if necessary. Personnel working with or near high voltage should be familiar with modern methods of resuscitation.

The following will appear in the text of this publication and is shown here for emphasis.

```
*****
*                               C A U T I O N                               *
*                               *                                           *
* Before any RF operation of the TERMALINE® is attempted,*
* the transmitter interlock and ac line attachment to the*
* equipment must be made. Attach the transmitter inter- *
* lock connections to the two binding posts on the con- *
* trol panel.                                           *
*****
```

```
*****
*                               W A R N I N G                               *
*                               *                                           *
* Do not insert a screwdriver or any thin metal objects *
* through the perforated cooling air grilles while the *
* load is in operation. The power within the unit could *
* arc over and will cause serious injury to personnel *
* and damage to the unit.                                           *
*****
```

```
*****
*                               C A U T I O N                               *
* Do not apply more than the rated RF power to the load. *
* Resistor failure could result.                                           *
*                               *                                           *
* Do not block air flow. Air enters housing through per- *
* forated grilles at the top of the unit and exhausts *
* through lower grilles of the unit. Blocking these *
* grilles could cause unit failure.                                           *
*****
```

SAFETY PRECAUTIONS

* W A R N I N G *
* *
* When using dry cleaning solvents, provide adequate *
* ventilation and observe normal safety precautions. *
* Many dry cleaning agents emit toxic fumes that *
* may be harmful to your health. *

* W A R N I N G *
* *
* Disconnect this unit from ac power source before any *
* disassembly for repair or replacement procedures. *
* The potential for electrical shock exists. *

TABLE OF CONTENTS

	<u>Page</u>
SAFETY PRECAUTIONS	i
INTRODUCTION	
General.....	v
Description.....	v
SECTION I - INSTALLATION	
Location.....	1
Mounting.....	1
Interlock Connections.....	1
Line Attachment.....	2
Connecting RF Line to Load.....	2
SECTION II - THEORY OF OPERATION	
General.....	3
RF Section Description.....	3
Heat Transfer.....	3
Interlock Control Circuit.....	4
SECTION III - OPERATING INSTRUCTIONS	
General.....	5
Load Power.....	5
Operation Under Normal and Abnormal Conditions.....	5
Shutdown.....	6
Measurement & Monitoring of RF Power.....	6
SECTION IV - MAINTENANCE	
General.....	7
Cleaning.....	7
RF Load Resistors.....	7
Enclosure Disassembly and Resistor Replacement.....	8
Diagnosing the RF Assembly.....	12
Thermoswitch and Reject Switch Replacement.....	12
Relay Replacement.....	14
Motor and Propeller Replacement.....	14
ON/OFF Switch, Fuse Holder and Pilot Lamp Receptical Replacement..	16
SECTION V - PREPARATION FOR RESHIPMENT	
General.....	17

Continued

TABLE OF CONTENTS

	<u>Page</u>
SECTION VI - STORAGE	
General.....	18
SECTION VII - REPLACEMENT PARTS LIST	
Models 8572/73.....	19
ILLUSTRATIONS	
Outline Drawing.....	vii
Back Panel Removal.....	10
RF Housing Panel Removal.....	10
Inside View.....	11
Center Resistor Support and Resistor Clips.....	11
Motor/Propeller Installed.....	20
Models 8570-74 Schematic Diagram.....	21
Optional Ductwork Adaptor.....	22
TABLES	
Specifications.....	vi

MODELS 8572/73 TERMALINE® LOAD RESISTORS

INTRODUCTION

GENERAL

This new series air cooled high power TERMALINE® Load resistor was designed to be a quiet, rugged and trouble free rigid RF line termination as a dummy antenna or as a standby reject load. They are forced air cooled and are capable of dissipating RF line power up to 25kW from dc to 250MHz. Virtually maintenance free and simple to operate, these units should provide years of trouble free operation yet are field repairable in the event of failure of the load resistor or other components. The RF sections are composed of a series-parallel network of resistors which allow the unit to remain in operation even if one or two of the resistors should fail.

DESCRIPTION

The units are rectangular in shape and stand approximately six feet high. They are supported on the bottom by four cylindrical shaped feet. The RF input connectors are located at the top center of the units. Perforated side panel grilles at the top and bottom of the units allow for direct forced air cooling of the resistors. The ac power receptacle, ON/OFF switch and transmitter interlock are located on the front panel of the units or control panel. The rear panels are removable for service accessibility. Two lower exhaust grilles on the right and rear sides, are removable for installation of an optional exhaust ductwork adapter.

SPECIFICATIONS FOR 8572/73 TERMALINE® LOAD RESISTORS

Impedance.....	50 ohms nominal
VSWR	
dc-110MHz.....	1.1:1 maximum
110-250MHz.....	1.15:1 maximum
Connectors	
Model 8572.....	3-1/8" EIA Swivel Flanged
Model 8573.....	3-1/8" Unflanged
Power Rating.....	25kW continuous duty
Frequency Range.....	dc-250MHz
Dimensions.....	16-1/4"L x 16-1/4"W x 70-3/4"H (412.7 x 412.7 x 1797mm)
Ambient Temperature.....	-40°C to +45°C (-40°F to +113°F)
Cooling Method.....	Forced air cooled
Weight.....	118 lbs. (54kg)
Motor.....	1/3HP, 1725RPM prelubricated ball bearing, thermally protected
AC Power Requirements	
115V ac.....	10 amps, 60Hz
230V ac.....	5 amps, 50Hz
Finish.....	Light navy grey and lusterless black baked enamel

Figure I-1. Models 8572/73 Outline Drawing.

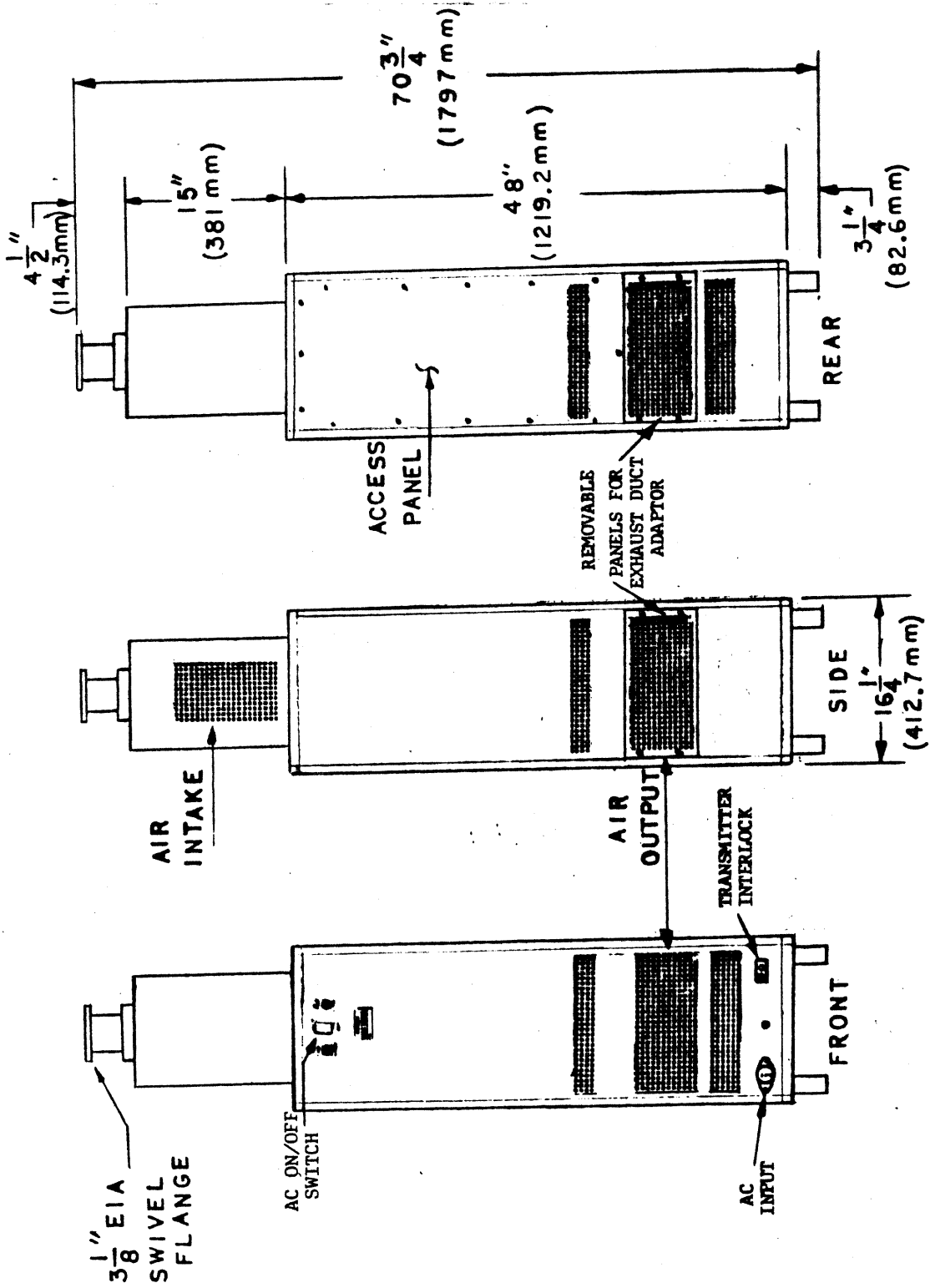

SECTION 1 - INSTALLATION

1-1. LOCATION

1-2. Being forced air cooled, the Models 8572/73 Load Resistor have no intermediate dielectric fluids or coolant and require no cooling water hookups. The unit may be placed conveniently anywhere adequate space is available for air circulation and an ac power source is handy. Do not enclose the unit in a small room or closet that has no means of ventilation. The heat given off by the unit may raise the ambient temperature to an unacceptable level for sufficient cooling of the resistors.

1-3. Since 25kW is equivalent to 85,000 Btu/h a sufficient quantity of air must be provided for cooling. Be sure the intake and exhaust grilles are unobstructed. As an optional item, an adaptor kit is available for outside exhaust ductwork. Contact the factory for information.

1-4. MOUNTING

1-5. There are no provisions for permanent mounting of these units, and the feet must not be removed to mount the unit to the floor. The cooling fan motor derives its cooling air from the bottom of the load; therefore, clearance underneath the load must be maintained.

1-6. INTERLOCK CONNECTIONS

```
*****
*                               C A U T I O N                               *
*                               *                                           *
* Before any RF operation of the TERMALINE® is attempted,*
* the transmitter interlock and ac line attachment to the*
* equipment must be made. Attach the transmitter inter- *
* lock connections to the two binding posts on the con- *
* trol panel.                                           *
*****
```

1-7. Always make the connection to the transmitter interlock first as a safety precaution in the unlikely event of the blower activating switch failure. Applying high RF power to the load without the blower fan running will cause failure of resistive elements.

1-8. There are three terminals on the interlock connection of the load. One terminal (A) is a common tiepoint and the other two are for normally open (C) or normally closed (B) contact connection, depending on the requirements of the transmitter used. Check the requirements of the transmitter interlock and make the connections to the appropriate terminals as required.

1-9. LINE ATTACHMENT

1-10. AC power, 115 or 230V depending on the unit requirements, is supplied to the 3-wire "Twistlock" panel socket by means of the ten foot, 3.05m, cable and matching plug that is furnished with the load equipment. The third wire in the cable, coded green, is the ground. For proper protection if a 3-wire type plug and outlet is not used, fasten the green wire at the supply end to a satisfactory ground. Do not detach the ac cable, only when necessary or when disconnection of the RF power supply to the load is definitely assured. Observe the warning label on the front panel. Do not apply RF power to the unit unless the power cord is connected. Even if the ON/OFF switch is in the OFF position the blower will automatically turn on shortly after RF power is supplied. This feature makes the load especially suited as a reject load for standby operation.

1-11. CONNECTING RF LINE TO LOAD

1-12. After installation, the coaxial RF transmission line may be attached. For the respective Models 8572 and 8573 the connections are as follows:

a. Model 8572, 3-1/8 inch EIA, 50 ohm with swivel flange.

1. Use 3-1/8 inch EIA coupling kit, P/N 4600-020, which includes: six each 3/8-16 x 1-1/2 bolt and nut sets, O-Ring, and insulated center bullet.

2. Insert the center bullet, push in until insulator is seated in facing, and install O-Ring in groove.

3. Connect coaxial input in straight line, push carefully on center contact to close. The swivel flange on the load makes connection independent of a fixed flange on the coaxial input outer conductor.

4. Insert bolt sets, tighten evenly all around.

b. Model 8573, 3-1/8 inch unflanged, 50 ohm.

1. Use 3-1/8 inch unflanged coupling kit, P/N 5-726 or RCA MI-27791-4A, which includes: an outer sleeve with two clamping bands, and the center conductor coupling bullet.

2. Insert center bullet and bottom it on the midpoint nibs.

3. Position the outer sleeve, with clamps, over input connector.

4. Introduce transmission line and seat snugly against the coupling stops.

5. Position clamp bands evenly about 3/4 inch from ends of sleeve and tighten.

SECTION II - THEORY OF OPERATION

2-1. GENERAL

2-2. The Models 8572/73 are high power air cooled RF loads for termination of coaxial transmission lines. The RF energy, converted into heat, is transmitted directly to the surrounding area by forced air without any intermediate dielectric transfer fluid or finned heat exchangers.

2-3. RF SECTION DESCRIPTION

2-4. The RF section, of the Models 8572/73, is composed of a series-parallel array of tubular resistors. These resistors are carefully positioned to provide a reduction in surge impedance proportional to the distance along the resistive system which finally terminates to the housing forming the return path for the coaxial circuit. This produces a very uniform and almost reflectionless line termination over the stated frequencies of the load resistor.

2-5. An advantageous feature of this series-parallel resistor network design is that it allows the unit to remain in operation in the unlikely event of failure of one or two of the resistive elements with little or no increase in reflected power.

2-6. Consider if one resistor in a parallel circuit of ten would be completely removed. That would mean a 10% increase in resistance. If these resistors are in series with another parallel circuit of ten resistors, there would be an increase of only 5%. This is an acceptable level and will not affect, to an appreciable amount, the operation of the load or readings if used with a THRULINE Wattmeter. It is not implied that these should continuously be used this way, but merely that they may be used with a defective element until the load can be repaired or the defective element replaced.

2-7. HEAT TRANSFER

```
*****  
*                               W A R N I N G                               *  
*                                                                                   *  
* Do not insert a screwdriver or any thin metal objects *  
* through the perforated cooling air grilles while the *  
* load is in operation. The power within the unit could *  
* arc over and will cause serious injury to personnel *  
* and damage to the unit. *  
*****
```

2-8. The resistors used in the Models 8572/73 are of a tubular type, situated in a vertical position within their housing. When the unit is in operation, a fan located at the bottom of the unit draws air into the top grille openings and directs it over the RF resistor network. The heat, developed in the resistors from dissipation of the RF energy, is carried off by the flow of air over the resistors surface. This hot air is then exhausted through the lower grille openings in the unit. With this forced

air entering at the top and being directed downwards, the RF input connector and coaxial line, or as the case may be a THRULINE Wattmeter mounted in the coaxial line, remain cool. This is helpful in maintaining the accuracy of a THRULINE® as well as in permitting disconnection of the coaxial line section immediately after the RF power has been turned off without the discomfort of handling a hot coaxial line connection.

2-9. INTERLOCK CONTROL CIRCUIT

2-10. The interlock control circuit provides fail-safe protection of the transmitter and load resistor in the event of ac power failure to the cooling fan motor. This protection is necessary because dissipation of the heat generated by the RF power is critically dependent upon a required minimum flow of cooling air at all times. Without this air flow, the power handling capabilities of the load are reduced to approximately 2kW of power.

2-11. The interlock system consists of an over temperature switch, thermoswitch, and relay switch interlock control. The over temperature switch, is a normally closed contact switch located in the center of the RF section. When ac power is applied to the load the interlock relay is energized and the contacts of the relay actuate for normally open or normally closed operation and the circuit to the transmitter interlock is completed, allowing the transmitter to turn on. Note - The interlock may be wired for normally open or closed operation, see 1-6, Interlock Connections. The RF power then flows into the load and is absorbed by the resistive element which in turn releases the RF power in the form of heat. The blower fan, being turned on by either the ON/OFF switch or the automatic mode switch, draws cooling air through the resistor network dispersing the heat into the surrounding air. If the air flow over the resistor array should stop or be restricted, and the temperature in the chamber should rise beyond a safe limit, the thermoswitch will open reversing the above process and shutting off the transmitter. The interlock system will not permit reoperation of the transmitter until a safe low temperature and the required air flow is once again attained.

SECTION III - OPERATING INSTRUCTIONS

3-1. GENERAL

```
*****  
*                               C A U T I O N                               *  
* Do not apply more than the rated RF power to the load. *  
* Resistor failure could result. *  
*                               *  
* Do not block air flow. Air enters housing through per-*  
* forated grilles at the top of the unit and exhausts *  
* through lower grilles of the unit. Blocking these *  
* grilles could cause unit failure. *  
*****
```

3-2. The Models 8572/73 have only one operating control, the ON/OFF switch. When installed according to Section I - Installation, the only requirement is for the ON/OFF switch to be placed in the ON position except when used as a standby reject load. Notice that the red power light comes on when the blower motor is running. The unit is now ready to accept RF power. Once the unit is set, there is no need for the presence of an operator.

3-3. LOAD POWER

3-4. It is advised that these units are not operated above their rated capacity; i.e., 25kW of power. The units will handle a small percentage of overload until the interlock system's thermoswitch opens due to over temperature and turns off the transmitter. If a large amount of overloading occurs, resistor failure is eminent before the interlock system reacts.

3-5. OPERATION UNDER NORMAL AND ABNORMAL CONDITIONS

3-6. At normal power operation, the units operate at temperatures just warm to the touch; therefore, presents no danger of burns when touched by operating personnel. This is accomplished by natural air convection between the RF housing and outer surface of the unit.

3-7. When these units are used in a confined area or a small room, they will cause the ambient temperature to rise considerably. This can be avoided by adding an optional ductwork adaptor kit and venting the exhaust air to the outside. This is recommended only when absolutely necessary. Ductwork must be properly designed with elbows and lengths held to a minimum, no 90° bends, so excessive back pressure is not created. Ductwork may exceed dimensions but must not be smaller than the adapter. Included with the ductwork adapter kit, P/N 8572-090, are two exhaust grille plates to stop the air flow of the hot exhaust air from the front and left side grilles. Without these plates installed only about 50 percent of the warm exhaust air will be vented to the ductwork and 50 percent directed back into the room. The exact amount of exhausted air vented into the room will depend on the amount of back pressure created by the installed ductwork. Consult with the factory for further information.

3-8. SHUTDOWN

3-9. When operation of the load has been completed, always turn off the transmitter first. Before turning the ac power off, allow the fan motor to run a few minutes without RF power being applied. Normally the blower activating switch will keep the fan motor running as long as the power has not been disconnected. This allows the resistive elements to cool. Disconnection of the coaxial RF line may be made immediately after the RF power has been turned off, even though the cooling fan is still running.

3-10. MEASUREMENT AND MONITORING OF RF POWER

3-11. The Models 8572/73 Load Resistor may be used in conjunction with any one of the various Bird 3-1/8 inch coaxial line THRULINE® Wattmeters. When fitted with the appropriate line section and wattmeter, either Model 8572/73 becomes a useful tool for tuning and adjusting a transmitter as well as monitoring RF power directly in watts. Consult with the factory for available THRULINE® Wattmeters and other pertinent information.

SECTION IV - MAINTENANCE

4-1. GENERAL

4-2. Since the Models 8572/73 are of a relative simple yet rugged design, only a moderate amount of preventive maintenance is required. Use reasonable care in handling; do not subject the unit to hard blows or jarring. These units are designed for use in a vertical position; do not operate them on any surface that is not relatively horizontal. These loads are designed to operate for long periods of time without failure if care is taken not to exceed their power handling capabilities.

4-3. CLEANING

```
*****
*                               W A R N I N G                               *
*                               *                                           *
* When using dry cleaning solvents, provide adequate                       *
* ventilation and observe normal safety precautions.                       *
* Many dry cleaning agents emit toxic fumes that                         *
* may be harmful, if inhaled.                                             *
*****
```

4-4. A main factor in effective preventive maintenance is cleanliness, for optimum performance and service life, the load must be kept in a clean and dust-free condition. During periods of inaction, or if the unit is to be stored for a period of time, keep the unit covered with a cloth or plastic sheet to prevent the intrusion of dust, dirt or moisture, especially the RF connector.

4-5. The outside surface of the unit should be wiped free of dust and dirt occasionally. When necessary the inner RF housing and the outside housing may be cleaned with a mild detergent solution on a cloth. The back and right side panels may be removed without difficulty for cleaning purposes, see Paragraphs 4-10 and 4-14. Give particular attention to the air intake and exhaust grilles. These grilles must be kept clear of dust, lint or any matter that may cause restriction of air flow.

4-6. Occasionally check the condition of the RF coaxial connection. If required, disconnect the unit from the transmission line and clean the RF connector parts, both metallic and insulator surfaces. When cleaning these parts and all other electrical parts, use an aerosol contact cleaner or any dry cleaning solvent. Use a cloth to wipe the surfaces; a swab stick is also useful for this purpose.

4-7. RF LOAD RESISTORS

4-8. Measurement of the dc resistance between the inner and outer conductors of the RF input connector will provide a relative check on the condition of the load resistors. Use an accurate ohmmeter or resistance bridge equipped with clip leads for this measurement. The resistance should be close to 50 ohms nominal. It is recommended that this resistance check be performed at room temperature and recorded for future reference before and

after each operation of the load. If at any time a drastic change in resistance is noticed, or if you have reason to believe one or more resistors have been damaged, the unit must be opened and each resistor checked individually to determine which, if any, are defective. Follow the resistor removal and replacement procedure, see Paragraph 4-10.

4-9. ENCLOSURE DISSASSEMBLY AND RESISTOR REPLACEMENT

```
*****
*                               W A R N I N G                               *
*                               *                                           *
* Disconnect this unit from ac and RF power source                       *
* before any disassembly for repair or replacement pro-                 *
* cedures. The potential for electrical shock exists.                   *
*****
```

4-10. As mentioned previously, the Models 8572/73 RF Load are field repairable. For assistance before and during disassembly, see Figures 4-1, 4-2, 4-3, 4-4. To change the resistive elements proceed with the following steps:

- a. Remove the 13 #8-32 x 5/16 pan head machine screws from the edges of the back access panel and the single 1/4-20 pan head screw from the bottom center, just above the removable grille of the back panel. The back panel is now free to be removed.
- b. Remove the four #8-32 pan head screws from the mid-back exhaust grille work and remove this grille.
- c. With the outer housing, upper, and mid-back panels removed, the RF section housing is exposed. The back panel of this housing must now be taken off.
- d. Remove the 16 #8-32 x 9/32 pan head screws on the right and left edges of this panel. Note - There are three Phillips head screws at the top edge of the RF housing back panel and one in the upper center of this panel, do not remove these screws. Remove the three slotted head #8-32 x 9/32 screws located on the back edge of the top RF input flange support panel.
- e. Remove the three #8-32 x 9/32 pan head screws from the outer edge of the rear small rectangular breather grille, on the top step of the outer housing. Also remove three #8-32 screws from the lower lip of the RF housing. These are removed from underneath the mounting plate.
- f. Remove the two 1/4-20 x 2-3/4 round head screws located on the lower section of the inner panel, just above the bottom flange. These 1/4-20 x 2-3/4 screws project through the RF housing panel and through the lower resistor support bracket, and are captivated by a 7/16, 1/4-20 nut. When removing these screws, it is necessary to put your hand into the RF section through the fan propeller, and hold the 7/16 nuts to keep them from turning. When loose, remove the nuts through the propeller blade opening.

g. The RF housing panel is now loose and ready to be taken off. There are metal plates fastened on the inside at the top of the front and rear RF housing panels. When they are removed, the top of the panel must be pulled out to clear a supporting rail. The panels may then be lifted upwards to clear the top frame work of the outside housing.

h. With the rear RF housing panel removed, you are now ready to test and replace the load resistors. The resistors are held very firmly by their clips and the possibility of their chipping or cracking upon removal is eminent, unless reasonable care is taken. Do not force the resistors out of the clips. It is advised to use some sort of tool to spread the clips somewhat when removing the resistors. We recommend retaining ring pliers, spreader type, as a very useful tool for this purpose.

i. Remove one end of a resistor at a time. Removal of the exposed bank of resistors should present no problem. However, the rear bank of resistors may be more difficult since they are in a confined space facing away from you. Remove the lower inside resistors by first detaching the top of the resistors from the center resistor support. Lift the resistor up and slide it out of the lower clamp. You may find it necessary to remove all the outer, exposed, resistors before removing the opposite inner resistors.

j. To reassemble the resistors and panels it is simply a matter of reversing the disassembly procedure above.

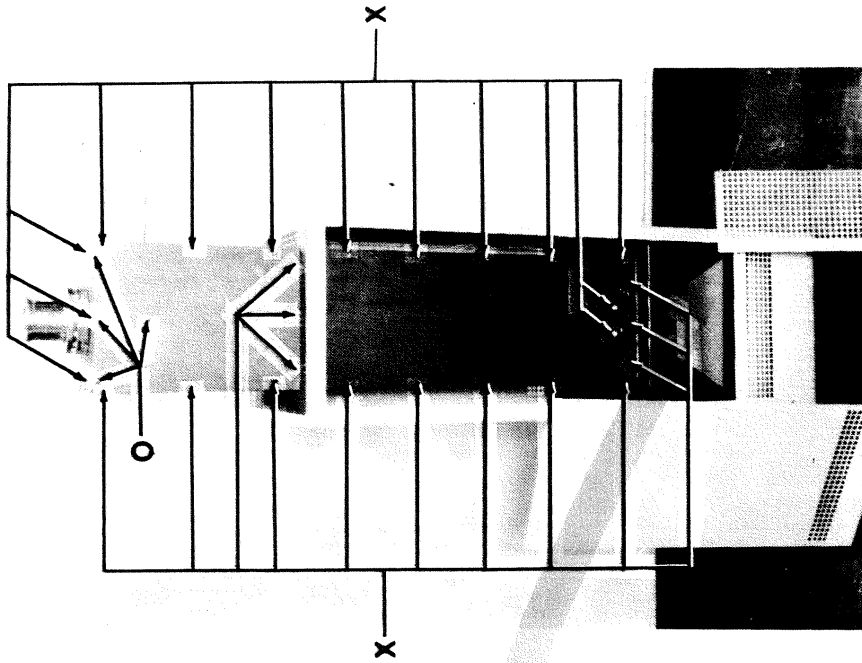

Figure 4-2. Models 8572/73 RF Housing Panel Removal. Remove screws marked "X" for RF section rear panel removal. Do not remove any screws marked by an "O".

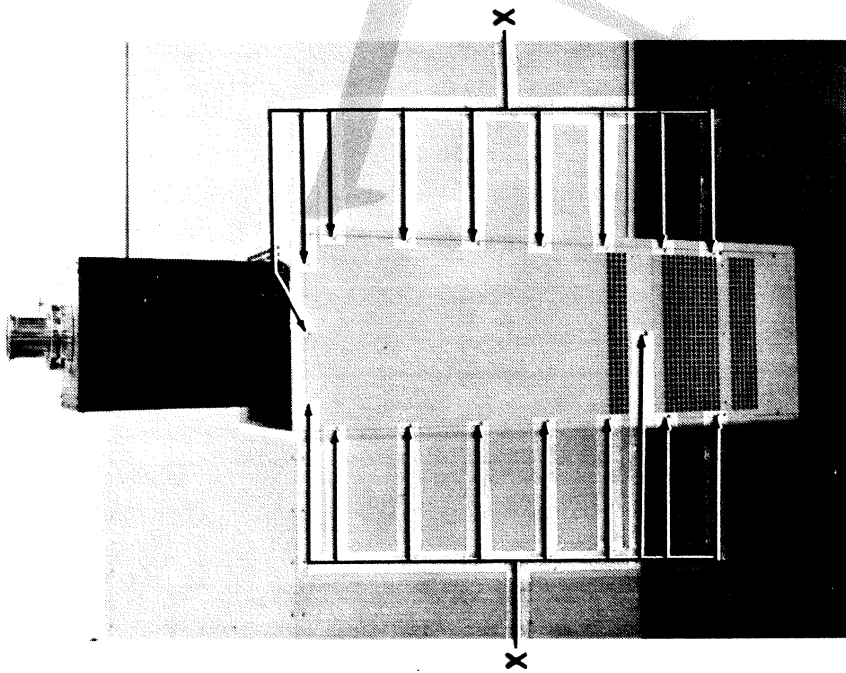

Figure 4-1. Models 8572/73 Back Panel Removal. Remove screws marked "X" for rear panel removal.

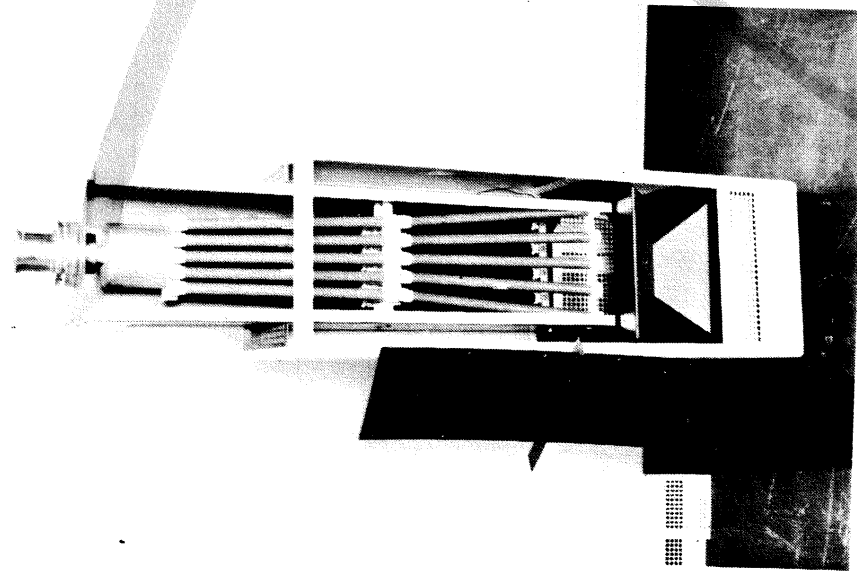
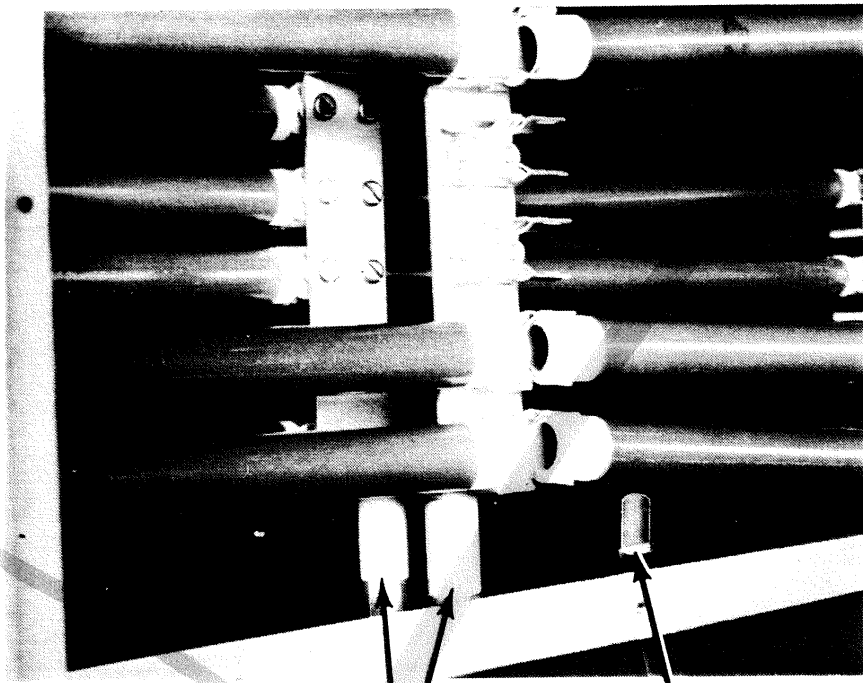

Figure 4-3. Models 8572/73 Inside View. Inner and outer back panels removed showing RF load resistor array.



CERAMIC SUPPORTS

THERMOSWITCH ASSEMBLY

Figure 4-4. Models 8572/73 Center Resistor Support And Resistor Clips.

4-11. DIAGNOSING THE RF ASSEMBLY

4-12. As mentioned, the RF section is comprised of a series-parallel configuration. There are two networks of parallel resistors in series. Each network has two branches, each with five 250 ohm resistors in parallel. These two branches are in parallel with each other resulting in a 25 ohm network. When one of these networks is in series with a similar network, the total resistance is a nominal 50 ohms.

4-13. If there has been a drastic change in the resistance of the load or if you have reason to suspect a resistor has failed, the following procedure may be helpful in finding a faulty resistor.

4-14. First make a visual inspection of all the resistors. Check for cracks or burned spots on the surface of each resistor. If no visual discrepancies are found to indicate resistor failure, it will be necessary to make resistance measurements. A suggested method is outlined below:

a. Use an accurate ohmmeter and measure the resistance of the top resistor network, from the top resistor support to the center or mid resistor support. Record this resistance measurement.

b. Check the lower resistor network by attaching the ohmmeter leads between the center resistor support and a good ground or preferably the lower resistor supports. Record this resistance measurement and compare this data.

1. If the resistance of one network exceeds the other by more than five ohms, 20% of a nominal 25 ohm, check each resistor of that network.

2. If one or both networks exceed a ± 5 ohm limit of a nominal 25 ohms; i.e., less than 20 ohms or more than 30 ohms, then each resistor of that or, as the case may be, both networks will have to be checked. Remove each resistor of each branch and check individually.

c. None of the resistors should exceed a $\pm 20\%$ tolerance. If a resistor is found to exceed 300 ohms, or to be less than 200 ohms, then that resistor should be replaced.

4-15. THERMOSWITCH AND REJECT SWITCH REPLACEMENT

4-16. The over-temperature thermoswitch and the blower actuation switch, "reject switch", are replaced by basically the same procedure.

4-17. The thermoswitch is mounted on the right RF housing panel centered just below the ceramic supports for the center resistor support bracket. The reject switch is mounted on the same panel below the thermoswitch but more to the back of the unit. In case of failure, these switches may be replaced by the following procedure.

- a. Remove the side outer housing panel by unscrewing the #8-32 x 9/32 pan head screws on the perimeter of the panel and the 1/4-20 x 1/2 pan head screw at the lower center of the panel. In a like manner, remove the mid or grille panel. Refer to Subparagraph 4-10a and b.
- b. After the side outer housing has been detached and set aside, remove the RF housing back panel; remove the 16 #8-32 x 9/32 pan head screws on the edges of this panel. Do not remove the Phillips head screws at the top of the panel. However, three screws on the top edge of the load just above the panel must be removed, see Subparagraph 4-10d.
- c. Remove the three #8-32 x 9/32 pan head screws from the edge of the small rectangular grille, on the top step of the outer housing. Remove the three #8-32 pan head screws that secure the panel lip to the mounting plate. These are removed from underneath the mounting plate.
- d. Remove the two #1/4-20 x 2-3/4 screws on the lower section. These screws are secured by a #7/16 x 1/4-20 nut and project through the RF housing panel and the lower resistor support. It will be necessary to reach your hand through the propeller and hold these nuts when removing the 1/4-20 screws. Remove these nuts through the propeller when free.
- e. The rear RF housing panel is now loose and ready to be taken off. Pull outward at the top edge of the panel to clear a mounting rail and plate assembly. When the top is clear a mounting rail and plate assembly. When the top is clear, pull the panel upward to clear the top framework of the outer housing.
- f. Remove the upper section of the right side panel. This is the only side panel made in three sections. To remove this panel simply remove the 13 #8-32 x 9/32 pan head screws around the edges and one 1/4-20 pan head screw at the power center of the panel. When these screws are removed, the panel will come right off.
- g. With the right side panel removed, notice the thermoswitch and the reject switch mounted on the wall of the front RF housing panel. The exposed portion is the microswitch with the interlock wires attached. The sensor section mounts through the wall of the RF panel. The thermoswitch is secured by two 3/4 hex nuts directly on the sensor body and the reject switch is secured by one 6-32 screw.
- h. Disconnect the wires leading to the switch to be replaced. Normally these will be the poles marked "common", normally closed, for the thermoswitch or "common", normally open, for the reject switch. Connect the wires to the same poles on reassembly.
- i. Using a 3/4 end wrench, reach inside the RF housing and remove the 3/4 nut holding the thermoswitch sensor in place. In some cases it may be necessary to hold the outside 3/4 nut with another wrench while loosening the inside nut. The reject switch is removed by

simply removing the 6-32 screw holding it. The thermoswitch may now be withdrawn from outside the RF housing front panel.

j. To reassemble a new thermoswitch, or reject switch, reverse the disassembly procedure above.

4-18 RELAY REPLACEMENT

4-19. The fan motor relay and interlock relay replacement procedure is the same. They are similar in configuration and are situated in the same general location inside at the bottom of the front control panel. For convenience in determining one from the other the relays are numbered (1) for motor relay and (2) for interlock relay. For replacement procedures follow the steps below:

a. Detach all power connections to the load and carefully lay the entire load on its side.

b. On the inside lower front panel, you will notice the relays. Determine which one must be replaced and remove the #6-32 screw and nut set securing the relay to the front panel. The screw head is accessible on the front panel.

c. When the relay is free from its mounting, position it so that the connection wires may be unsoldered easily. Before unsoldering, tag each wire with the number that corresponds to the number by each pole on the relay. This will identify the wires when resoldering them to the correct poles. Also refer to the wiring diagram.

d. To reassemble the unit, simply reverse the steps outlines above.

4-20. MOTOR AND PROPELLER REPLACEMENT

4-21. When replacing the motor or propeller, the entire unit must be placed on the left-hand side. This is the side with the one piece panel. Place it gently on a padded or cloth covered surface so not to mar its surface. The bottom and middle right side grilled panel must be removed to replace the motor and/or propeller. The steps following, detail the disassembly procedure.

a. Remove the four #8-32 pan head screws that secure the middle grille panel of the right side. With the unit on its side, this panel will be facing up. When this panel is removed, the bottom 2/3 portion of the propeller will be exposed. The propeller must be positioned the same way at reassembly. It may be useful to mark one or two of the blades at the bottom of the propeller shroud for alignment when reassembling.

b. Using a 5/32 Allen wrench, loosen the two 5/16-24 socket head set screws on the propeller hub. The propeller is not removed at this time.

c. Disconnect the ac wires that power the motor/capacitor combination at the splice near the motor. Tag each wire to assure correct connections in reassembling.

d. Using a 7/16 socket or box wrench, loosen and remove the four 1/4-20 hex head screws that secure the motor base to the motor mounting bracket. Be sure to support the motor while removing these screws.

e. Hold the propeller and slide the motor straight out of the bottom of the unit. The propeller will slide off of the motor shaft as the motor is retracted. If there is any restriction the set screws may have to be loosened a bit more.

f. With the motor removed, the propeller will have to be turned or manipulated to free it from the unit. It may be necessary, especially with the 50Hz propeller, to remove the three #8-32 pan head screws at the base of the pyramid air deflector. This will allow the deflector to be pushed down somewhat in order to free the propeller from the propeller cavity. This may still take some manipulation, but be careful not to bend the blades of the propeller out of shape as this could cause undesirable vibration.

g. When reinstalling the motor/propeller assembly, install the propeller in its cavity first with the hub facing down then, if removed, replace the three #8-32 screws at the base of the pyramid.

h. With the propeller in its cavity, insert the motor in the bottom of the unit with its shaft going through the hole in the bottom side of the air deflector pyramid. At the same time, hold the propeller so the shaft enters the hole in the hub. Slide the propeller slightly on the shaft, but do not tighten.

i. Insert the 1/4-20 hex screws through the motor base and screw them into the motor mounting bracket until it is snug but not tight. Position the propeller so that about 2/3 of the blades are showing below the shroud, or until the previously made marks are aligned at the bottom of the shroud. Tighten the set screws slightly on the hub.

j. Turn the propeller and notice if it hits the shroud. The motor will possibly have to be repositioned on the mounting bracket until the propeller spins freely without hitting the shroud.

k. When the propeller spins freely without touching the shroud, tighten the motor mounting screws securely and also the socket set screws on the propeller hub. Complete the reassembly by reversing the disassembly procedures previously listed and test the motor/propeller operation under ac power. It may be useful to test the unit with ac power before the side panels are reattached in case realignment of the motor is required.

4-22. ON/OFF SWITCH, FUSE HOLDER AND PILOT LAMP RECEPTICAL REPLACEMENT

4-23. For replacement of the ON/OFF switch, fuse holder of pilot lamp receptical, the front panel must be removed. Follow the procedure below for front panel removal then the substeps for individual component disassembly. Care must be taken not to draw back the front panel too far as internal connecting wires will restrict its travel.

a. Remove the 22 #8-32 pan head screws from around the perimeter of the front panel.

b. Remove the three #8-32 pan head screws located between the lower and center grille work. Also remove the 1/4-20 pan head screw centered between the top and center grille work. The front panel is now detached and may be withdrawn sufficiently for parts replacement.

c. Replace the ON/OFF switch, fuseholder and pilot lamp receptical as individually listed below:

1. ON/OFF switch, Item 11 - Unsolder the wires to the switch lugs. Observe their position before unsoldering and return them to the same position when reconnecting. Depress the spring clip that holds the switch in place at the top and bottom. This will release the switch and it may be pushed out through the front of the panel. The new switch snaps in through the front of the panel. Resolder the wires to the bottom and center lug, on the same side to complete the connection.

2. Fuse holder, Item 12 - The fuse is released by pushing the insert in and slightly downwards allowing the fuse cap to spring out. The fuse is replaced in the cap. For protection of the equipment, do not replace the fuse with one of a higher rating than the 15 amp installed. When reinserting the cap, make sure the word "FUSE" reads horizontally, right side up. To remove the fuse holder, unsolder the wires on the fuse holder terminals. Pinch the clamps on each side of the holder and pull it out through the front panel. Note - In replacing this part, the word "TOP" on its body should face upward. The fuse holder snaps in through the front panel.

3. Pilot lamp and receptical, Items 14 and 15 - the NE-51 pilot lamp is replaced by unscrewing the red plastic lens in a counterclockwise direction, pushing in on the lamp and rotating it 1/8 turn in a counterclockwise direction. It will pull straight out. Replace it by aligning the base nibs with the receptical slot, pushing it in and rotating it 1/8 turn in a clockwise direction. Replace the receptical by unsoldering the leads to the terminals and removing the 7/8 hex nut and lock washer that secure the receptacle in place. It is now free and may be taken out through the front panel.

d. To reassemble the unit reverse procedures in Paragraph 4-23.

SECTION V - PREPARATION FOR RESHIPMENT

5-1. GENERAL

5-2. To reship or return the unit to the factory, first secure all loose parts such as the power cord and swivel flange. Pack it and seal securely in a sturdy wooden box or equivalent, with sufficient padding to avoid shock damage. If possible, keep the original shipping carton for reshipment.

SECTION VI - STORAGE

6-1. GENERAL

6-2. If the unit is to be unused or stored for any length of time, cover it with a cloth or plastic sheet and store it in a moisture free, cool, dry place. There is no special preparation to the unit; however, moisture will be the greatest concern. Ambient storage temperatures are not critical, but the relative humidity percent should be low.

SECTION VII - REPLACEMENT PARTS LIST

7-1. MODELS 8572/73

ITEM	QUANTITY	DESCRIPTION	PART NUMBER
1	20	Load Resistors	8572-021
2	1	Motor 115/230V, 50/60Hz	8572-037
3	1	Propeller	
		60Hz	8572-038
		50Hz	8572-077
4	1	Extension Shaft, Motor	8572-063
5	1	Switch, Blower Actuation	8572-089
6	1	Thermoswitch, Interlock	8572-088
7	1	Relay, Motor & Interlock	
		115V	5-1509
		230V	5-1515
8	1	Resistor, Neon Voltage Dropping	8640-081
9	1	Receptacle, AC	5-748
10	1	Power Cord, AC	8630-111-1
11	1	Switch, Power	8640-645
12	1	Holder, Fuse	5-998
13	1	Fuse	
		115V, 15A, Littlefuse, 3AB, 314015	5-721-9
		230V, 7A, Littlefuse, 3AG, 313007	5-721-10
14	1	Receptacle, Pilot Lamp	5-1507
15	1	Lamp, Pilot	5-1508
16	40	Clips, Resistor Holder	8572-091
17	4	Insulator, Ceramic Standoff	8450-052
18	1	Connector, RF Input	
		Model 8572, 3-1/8" Swivel Flange	8572-006
		Center Conductor	8572-005
		Model 8573, 3-1/8" Unflanged	8573-006
		Center Conductor	8573-005
19	1	Adapter, Ductwork, Optional; Includes exhaust grille plates	8572-078 8572-087

Figure 7-1. Models 8572/73 Motor/Propeller Installed.

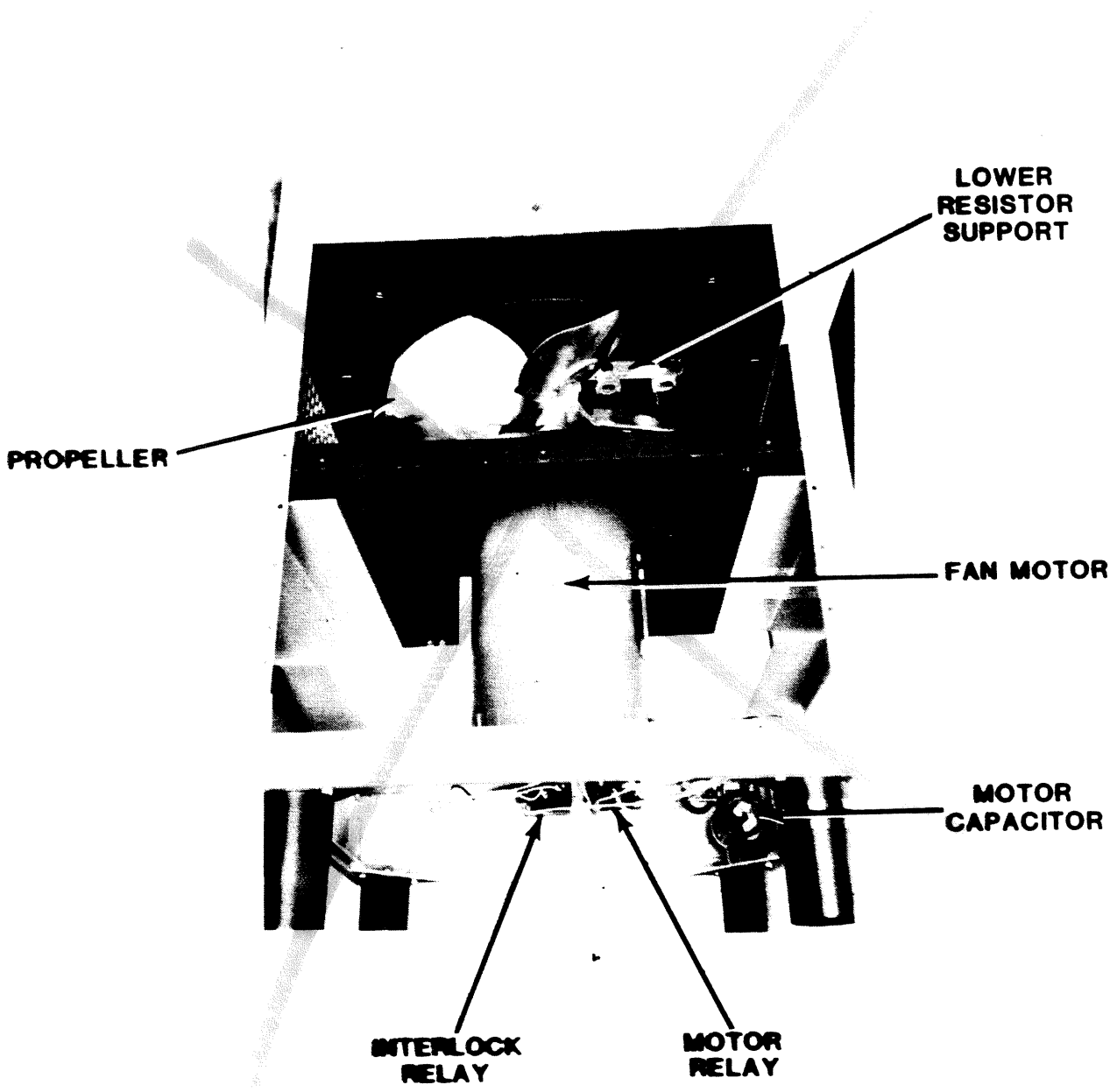
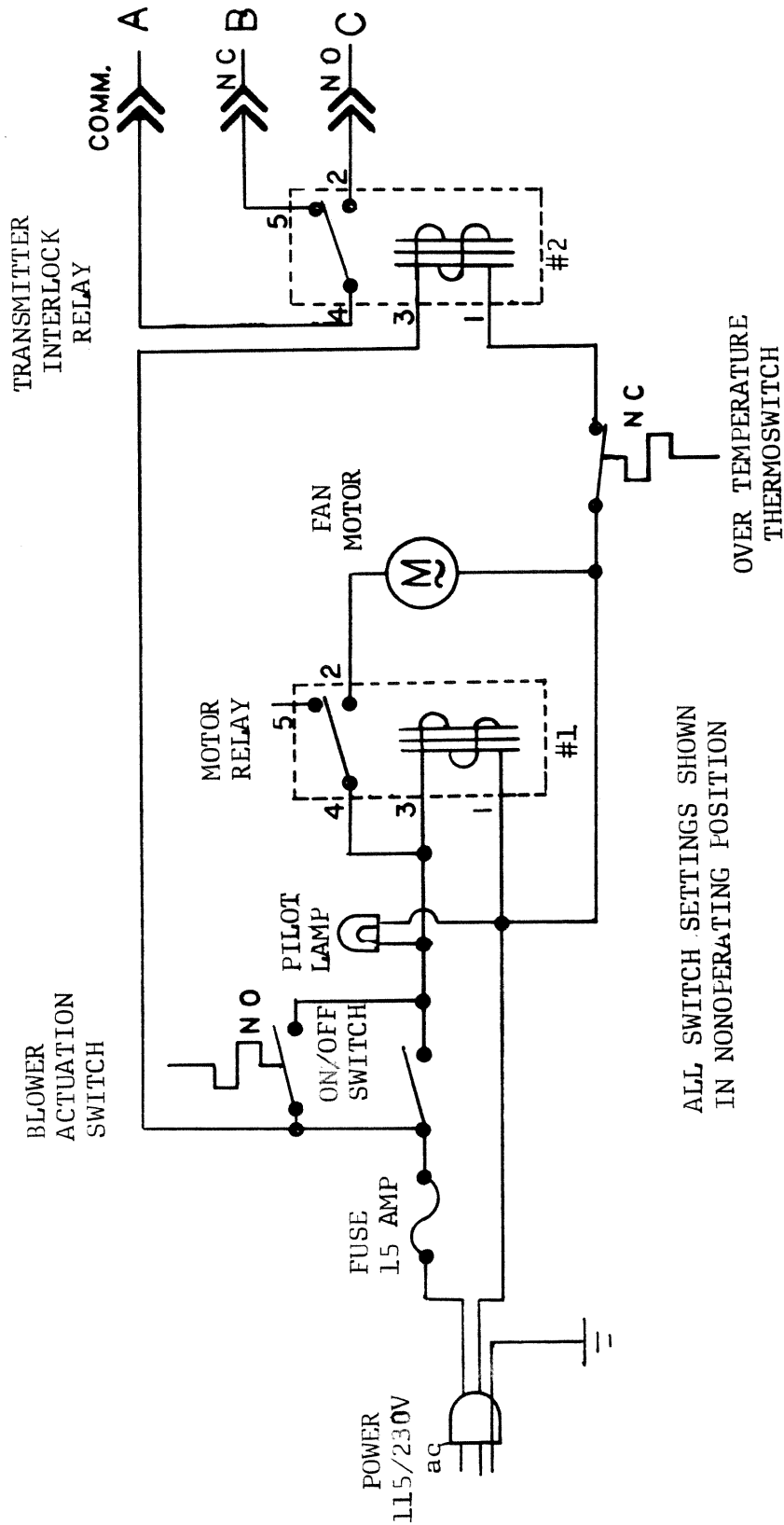

Figure 7-2. Models 8570-74 Schematic Diagram.



ALL SWITCH SETTINGS SHOWN
IN NONOPERATING POSITION

Models 8570/71/72/73/74
Wiring Diagram

Figure 7-3. Model 8572 With Optional Ductwork Adaptor.

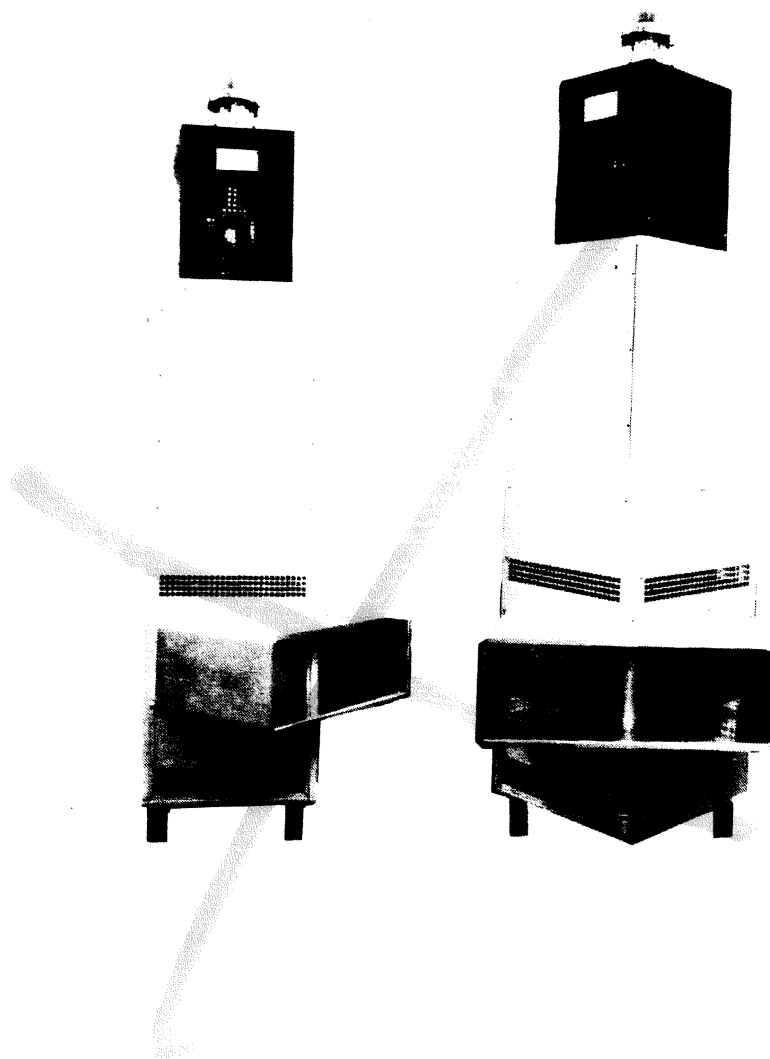

Right Side View

Right and Back Panel View.